

# OWNER'S MANUAL

Operation  
Maintenance  
Specifications

All information in this Owner's Manual is current at the time of publication. However, HYUNDAI reserves the right to make changes at any time so that our policy of continual product improvement may be carried out.

This manual applies to all HYUNDAI models and includes descriptions and explanations of optional as well as standard equipment. As a result, you may find material in this manual that does not apply to your specific vehicle.

### **CAUTION: MODIFICATIONS TO YOUR HYUNDAI**

Your HYUNDAI should not be modified in any way. Such modifications may adversely affect the performance, safety or durability of your HYUNDAI and may, in addition, violate conditions of the limited warranties covering the vehicle. Certain modifications may also be in violation of regulations established by the U.S. Department of Transportation and other federal or state agencies.

### **TWO-WAY RADIO INSTALLATION**

Your vehicle is equipped with a Tire Pressure Monitoring System, Passenger Occupant Classification System and other CAN bus systems. It is possible for an improperly installed/adjusted high powered two-way radio to adversely affect electronic systems. For this reason, we recommend that you carefully follow the radio manufacturer's instructions if you choose to install one of these devices.

---

## SAFETY AND VEHICLE DAMAGE WARNING

This manual includes information titled as DANGER, WARNING, CAUTION and NOTICE.

These titles indicate the following:



### **DANGER**

**DANGER** indicates a hazardous situation which, if not avoided, will result in death or serious injury.



### **WARNING**

**WARNING** indicates a hazardous situation which, if not avoided, could result in death or serious injury.



### **CAUTION**

**CAUTION** indicates a hazardous situation which, if not avoided, could result in minor or moderate injury.

### **NOTICE**

**NOTICE** indicates a situation which, if not avoided, could result in vehicle damage.

## HYUNDAI VEHICLE OWNER PRIVACY POLICY

Your Hyundai vehicle may be equipped with technologies and services that use information collected, generated, recorded or stored by the vehicle. Hyundai has created a Vehicle Owner Privacy Policy to explain how these technologies and services collect use and share this information.

You may read our Vehicle Owner Privacy Policy on the Hyundaiusa.com website at: <https://www.hyundaiusa.com/owner-privacy-policy.aspx>

If you would like to receive a hard copy of our Vehicle Owner Privacy Policy, please contact our Customer Care Center at:

Hyundai Customer Care  
P.O. Box 20850  
Fountain Valley, CA 92728  
800-633-5151  
[consumeraffairs@hmausa.com](mailto:consumeraffairs@hmausa.com)

Hyundai's Customer Care Center representatives are available Monday through Friday,

between the hours of 6:00 AM and 5:00 PM PST and Saturday between 6:30 AM and 3:00 PM PST (English).

For Customer Care assistance in Spanish or Korean, representatives are available Monday through Friday between 6:30 AM and 3:00 PM PST.



# Table of Contents

Introduction	1
Vehicle Information, Consumer Information and Reporting Safety Defects	2
Seats & Safety System	3
Instrument Cluster	4
Convenience Features	5
Driving Your Vehicle	6
Driver Assistance System	7
Emergency Situations	8
Maintenance	9
Index	I

# 1. Introduction

Introduction.....	1-2
Hyundai Motor America .....	1-2
Guide to Hyundai Genuine Parts .....	1-3
How to Use this Manual .....	1-4
Safety Messages .....	1-4
Fuel Requirements.....	1-5
Gasoline containing alcohol or methanol .....	1-5
Using Fuel Additives (except Detergent Fuel Additives) .....	1-6
Gasoline containing MMT .....	1-6
Detergent Fuel Additives.....	1-6
Operation in foreign countries.....	1-6
Vehicle Modifications .....	1-7
Vehicle Break-in Process .....	1-7
Vehicle Data Collection and Event Data Recorders .....	1-8

## INTRODUCTION

Congratulations, and thank you for choosing HYUNDAI. We are pleased to welcome you to the growing number of discerning people who drive HYUNDAs. We are very proud of the advanced engineering and high-quality construction of each HYUNDAI we build.

Your Owner's Manual will introduce you to the features and operation of your new HYUNDAI. To become familiar with your new HYUNDAI, so that you can fully enjoy it, read this Owner's Manual carefully before driving your new vehicle.

This manual contains important safety information and instructions intended to familiarize you with your vehicle's controls and safety features so you can safely operate your vehicle.

This manual also contains information on maintenance designed to enhance safe operation of the vehicle. It is recommended that all service and maintenance on your car be performed by an authorized HYUNDAI dealer. HYUNDAI dealers are prepared to provide high-quality service, maintenance and any other assistance that may be required.

This Owner's Manual should be considered a permanent part of your vehicle, and should be kept in the vehicle so you can refer to it at any time. The manual should stay with the vehicle if you sell it to provide the next owner with important operating, safety and maintenance information.

## HYUNDAI MOTOR AMERICA



### CAUTION

**Severe engine and transmission damage may result from the use of poor quality fuels and lubricants that do not meet HYUNDAI specifications. You must always use high quality fuels and lubricants that meet the specifications listed on Page 2-12 in the Vehicle Specifications section of the Owner's Manual.**

Copyright 2022 HYUNDAI Motor America. All rights reserved. No part of this publication may be reproduced, stored in any retrieval system or transmitted in any form or by any means without the prior written permission of HYUNDAI Motor America.

## GUIDE TO HYUNDAI GENUINE PARTS

### 1. What are HYUNDAI Genuine Parts?

HYUNDAI Genuine Parts are the same parts used by HYUNDAI Motor Company to manufacture vehicles. They are designed and tested for the optimum safety, performance, and reliability for our customers.



### 2. Why Hyundai Genuine Parts?

HYUNDAI Genuine Parts are engineered and built to meet rigid manufacturing requirements. Damage caused by using imitation, counterfeit or used salvage parts is not covered under the HYUNDAI New Vehicle Limited Warranty or any other HYUNDAI warranty.

In addition, any damage to or failure of HYUNDAI Genuine Parts caused by the installation or failure of an imitation, counterfeit or used salvage part is not covered by any HYUNDAI Warranty.



### 3. How can you tell if you are purchasing HYUNDAI Genuine Parts?

Look for the HYUNDAI Genuine Parts Logo on the package (see below).

HYUNDAI Genuine Parts exported to the U.S. are packaged with labels written only in English.

HYUNDAI Genuine Parts are only sold through authorized HYUNDAI Dealerships.



## HOW TO USE THIS MANUAL

We want to help you get the greatest possible driving pleasure from your vehicle. Your Owner's Manual can assist you in many ways. To gain an overview of the contents of your Owner's Manual, use the Table of Contents in the front of the manual. The first page of each Chapter includes a detailed Table of Contents of the topics in that Chapter.

To quickly locate information about your vehicle, use the Index in the back of the manual. It is an alphabetical list of what is in this manual and the page number where it can be found.

For your convenience, we have incorporated tabs on the right-hand page edges. These tabs are coded with the Chapter titles to assist you with navigating through the manual.

## SAFETY MESSAGES

Your safety, and the safety of others, is very important. This Owner's Manual provides you with many safety precautions and operating procedures. This information alerts you to potential hazards that may hurt you or others, as well as damage to your vehicle.

Safety messages found on vehicle labels and in this manual describe these hazards and what to do to avoid or reduce the risks.

Warnings and instructions contained in this manual are for your safety. Failure to follow safety warnings and instructions can lead to serious injury or death.

Throughout this manual DANGER, WARNING, CAUTION, NOTICE and the SAFETY ALERT SYMBOL will be used.



This is the safety alert symbol. It is used to alert you to potential physical injury hazards. Obey all safety messages that follow this symbol to avoid possible injury or death. The safety alert symbol precedes the signal words DANGER, WARNING and CAUTION.



### **DANGER**

**DANGER** indicates a hazardous situation which, if not avoided, will result in death or serious injury.



### **CAUTION**

**CAUTION** indicates a hazardous situation which, if not avoided, could result in minor or moderate injury.



### **WARNING**

**WARNING** indicates a hazardous situation which, if not avoided, could result in death or serious injury.

### **NOTICE**

**NOTICE** indicates a situation which, if not avoided, could result in vehicle damage.

## FUEL REQUIREMENTS

Your new vehicle is designed to obtain maximum performance with UNLEADED FUEL, as well as minimize exhaust emissions and spark plug fouling.

Your new vehicle is designed to perform optimally using unleaded fuel having an octane number  $((R+M)/2)$  of 87 (Research Octane Number 91) or higher. (Do not use methanol blended fuels)

### NOTICE

**To prevent damage to the engine and engine components, never add any fuel system cleaning agents to the fuel tank other than what has been specified.**

**Consult an authorized HYUNDAI dealer for additional information.**



### WARNING

- **Do not “top off” after the nozzle automatically shuts off when refueling.**
- **Always check that the fuel cap is installed securely to prevent fuel spillage in the event of an accident.**

### *Gasoline containing alcohol or methanol*

Gasohol, a mixture of gasoline and ethanol (also known as grain alcohol) are being marketed along with or instead of leaded or unleaded gasoline. For example, “E15” is a gasohol comprised of 15% ethanol and 85% gasoline.

Do not use gasohol containing more than 15% ethanol, and do not use gasoline or gasohol containing any methanol. Either of these fuels may cause drivability problems and damage to the fuel system, engine control system and emission control system.

Discontinue using gasohol of any kind if drivability problems occur.

“E85” fuel is an alternative fuel comprised of 85 percent ethanol and 15 percent gasoline, and is manufactured exclusively for use in Flexible Fuel Vehicles. “E85” is not compatible with your vehicle. Use of “E85” may result in poor engine performance and damage to your vehicle’s engine and fuel system. HYUNDAI recommends that customers do not use fuel with an ethanol content exceeding 15 percent.

### NOTICE

**To prevent damage to your vehicle’s engine and fuel system:**

- **Never use gasohol which contains methanol.**
- **Never use gasohol containing more than 15% ethanol.**
- **Never use leaded fuel or leaded gasohol.**
- **Never use “E85” fuel.**

**Your New Vehicle Limited Warranty does not cover damage to the fuel system or any performance problems caused by the use of “E85” fuel.**

### ***Using Fuel Additives (except Detergent Fuel Additives)***

Using fuel additives such as:

- Silicone fuel additive
- Ferrocene (iron-based) fuel additive
- Other metallic-based fuel additives

may result in cylinder misfire, poor acceleration, engine stalling, damage to the catalyst, or abnormal corrosion, and may cause damage to the engine resulting in a reduction in the overall life of the powertrain.

The Malfunction Indicator Lamp (MIL) may illuminate.

### **NOTICE**

**Damage to the fuel system or performance problem caused by the use of these fuels or fuel additives may not be covered by your New Vehicle Limited Warranty.**

### ***Gasoline containing MMT***

Some gasoline contains harmful manganese-based fuel additives such as MMT (Methylcyclopentadienyl Manganese Tricarbonyl).

HYUNDAI does not recommend the use of gasoline containing MMT.

This type of fuel can reduce vehicle performance and affect your emission control system.

The malfunction indicator lamp on the cluster may come on.

### ***Detergent Fuel Additives***

HYUNDAI recommends that you use good quality gasolines treated with detergent additives such as TOP TIER Detergent Gasoline, which help prevent deposit formation in the engine. These gasolines will help the engine run cleaner and enhance performance of the Emission Control System. For more information on TOP TIER Detergent Gasoline, please go to the website ([www.toptiergas.com](http://www.toptiergas.com)).

For customers who do not use TOP Tier Detergent Gasoline regularly, and have problems starting or the engine does not run smoothly, detergent-based fuel additives that you can purchase separately may be added to the gasoline. If TOP TIER Detergent Gasoline is not available, one bottle of additive added to the fuel tank according to the maintenance schedule is recommended (refer to the Maintenance Schedule in chapter 9).

Additives are available from your authorized HYUNDAI dealer along with information on how to use them. Do not mix other additives.

### ***Operation in foreign countries***

If you are going to drive your vehicle in another country, be sure to:

- Observe all regulations regarding registration and insurance.
- Determine that acceptable fuel is available.

## VEHICLE MODIFICATIONS

- This vehicle should not be modified. Modification of your vehicle could affect its performance, safety or durability and may even violate governmental safety and emissions regulations.
- In addition, damage or performance problems resulting from any modification may not be covered under warranty.
- If you use unauthorized electronic devices, it may cause the vehicle to operate abnormally, wire damage, battery discharge and fire. For your safety, do not use unauthorized electronic devices.

### **NOTICE**

**Some warning sounds (including welcome/good-bye sound, etc.) are generated from the interior speakers or amplifiers. If necessary, we recommend you to purchase HYUNDAI Part to replace an interior speaker or amplifier. Any unauthorized product may cause a malfunction of the interior speakers or amplifiers.**

## VEHICLE BREAK-IN PROCESS

- Do not race the engine.
- While driving, keep your engine speed (RPM, or revolutions per minute) between 2,000 RPM and 4,000 RPM.
- Do not maintain a single speed for long periods of time, either fast or slow. Varying engine speed is needed to properly break-in the engine.
- Avoid hard stops, except in emergencies, to allow the brakes to seat properly.
- Fuel economy and engine performance may vary depending on vehicle break-in process and be stabilized after 4,000 miles (6,000 km). New engines may consume more oil during the vehicle break-in period.
- Do not tow a trailer during the first 1,200 miles (2,000 km) of operation.

### **NOTICE**

#### **CALIFORNIA PROPOSITION 65 WARNING**

**Items contained in motor vehicles or emitted from them are known to the State of California to cause cancer and birth defects or reproductive harm. These include:**

- **Gasoline and its vapors**
- **Engine exhaust**
- **Used engine oil**
- **Interior passenger compartment components and materials**
- **Component parts which are subject to heat and wear**

**In addition, battery posts, terminals and related accessories contain lead, lead compounds and other chemicals known to the State of California to cause cancer and reproductive harm.**



## VEHICLE DATA COLLECTION AND EVENT DATA RECORDERS

This vehicle is equipped with an event data recorder (EDR). The main purpose of an EDR is to record, in certain crash or near crash-like situations, such as an air bag deployment or hitting a road obstacle, data that will assist in understanding how a vehicle's systems performed. The EDR is designed to record data related to vehicle dynamics and safety systems for a short period of time, typically 30 seconds or less. The EDR in this vehicle is designed to record such data as:

- How various systems in your vehicle were operating;
- Whether or not the driver and passenger safety belts were buckled/fastened;
- How far (if at all) the driver was depressing the accelerator and/or brake pedal; and,
- How fast the vehicle was traveling.

These data can help provide a better understanding of the circumstances in which crashes and injuries occur. NOTE: EDR data are recorded by your vehicle only if a non-trivial crash situation occurs; no data are recorded by the EDR under normal driving conditions and no personal data (for example, name, gender, age, and crash location) are recorded. However, other parties, such as law enforcement, could combine the EDR data with the type of personally identifying data routinely acquired during a crash investigation.

To read data recorded by an EDR, special equipment is required, and access to the vehicle or the EDR is needed. In addition to the vehicle manufacturer, other parties, such as law enforcement, that have the special equipment, can read the information if they have access to the vehicle or the EDR.

# 2. Vehicle Information, Consumer Information and Reporting Safety Defects

Exterior Overview (I) .....	2-2
Exterior Overview (II) .....	2-3
Interior Overview .....	2-4
Instrument Panel Overview (I) .....	2-5
Instrument Panel Overview (II) .....	2-6
Engine Compartment .....	2-7
Dimensions .....	2-8
Engine .....	2-8
Bulb Wattage .....	2-9
Tires and Wheels .....	2-10
Air Conditioning System .....	2-11
Vehicle Weight and Luggage Volume .....	2-11
Recommended Lubricants and Capacities .....	2-12
Recommended SAE Viscosity Number .....	2-13
Vehicle Identification Number (VIN) .....	2-14
Vehicle Certification Label .....	2-14
Tire Specification and Pressure Label .....	2-14
Engine Number .....	2-15
Air Conditioner Compressor Label .....	2-15
Consumer Information .....	2-16
Reporting Safety Defects .....	2-17

## EXTERIOR OVERVIEW (I)

■ Front view



**The actual shape may differ from the illustration.**

A0001EU02

- |                           |      |                                      |             |
|---------------------------|------|--------------------------------------|-------------|
| 1. Hood.....              | 5-82 | 6. Sunroof.....                      | 5-71, 5-75  |
| 2. Headlight.....         | 9-57 | 7. Front windshield wiper blades ... | 5-110, 9-25 |
| 3. Side marker lamp ..... | 9-57 | 8. Windows .....                     | 9-25        |
| 4. Tires and wheels.....  | 9-31 | 9. Front radar .....                 | 7-4         |
| 5. Side view mirror.....  | 5-57 |                                      |             |

## EXTERIOR OVERVIEW (II)

### ■ Rear view

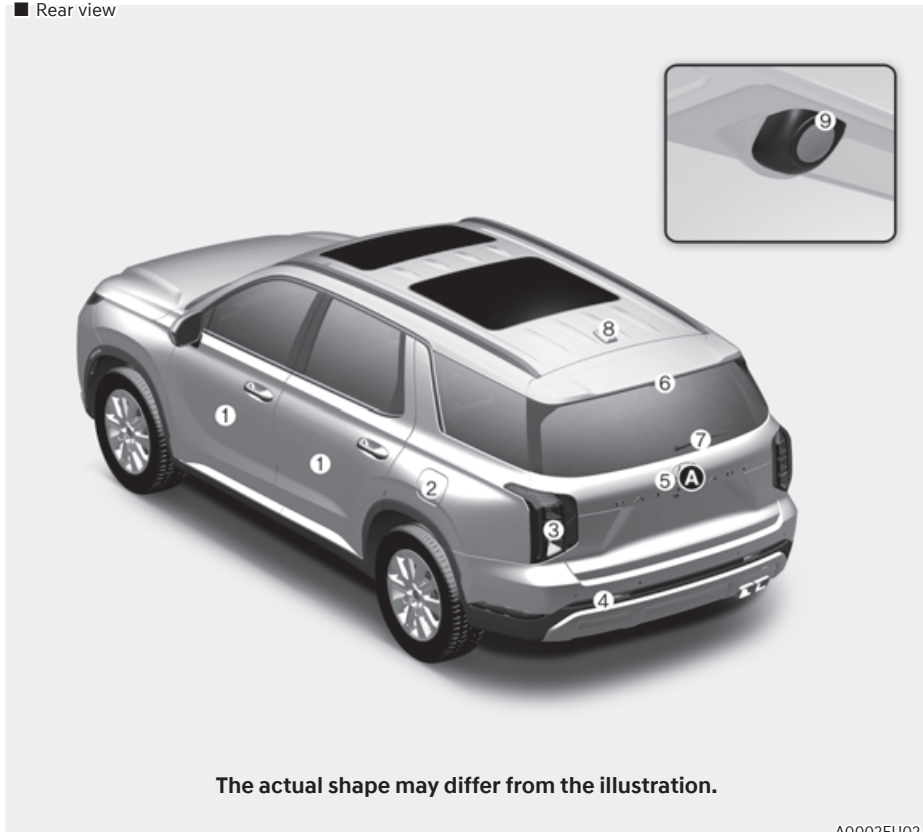

A0002EU02

- |                               |      |                                   |       |
|-------------------------------|------|-----------------------------------|-------|
| 1. Door.....                  | 5-29 | 6. High mounted stop lamp.....    | 9-60  |
| 2. Fuel filler door.....      | 5-29 | 7. Rear window wiper blades ..... | 5-113 |
| 3. Rear combination lamp..... | 5-29 | 8. Antenna.....                   | 5-170 |
| 4. Reverse lamp .....         | 9-58 | 9. Wide-rear view camera.....     | 7-110 |
| 5. Liftgate.....              | 5-83 |                                   |       |

## INTERIOR OVERVIEW



The actual shape may differ from the illustration.

A0003EU01

- |   |  |
|---|--|
| 1. Inside door handle.....5-32  | 8. ESC (Electronic Stability Control) OFF button..... 6-38 |
| 2. Side view mirror control switch..... 5-58                                  | 9. Power liftgate open/close button ..... 5-87             |
| 3. Central door lock switch ..... 5-33  | 10. EPB (Electronic Parking Brake) switch . 6-28           |
| 4. Power window switches ..... 5-66   | 11. Hood release lever..... 5-82                           |
| 5. Power window lock button/<br>Electronic child safety lock button..... 5-69 | 12. Steering wheel tilt/telescopic lever .... 5-45         |
| 6. Instrument panel illumination<br>controlswitch ..... 4-5                   | 13. Steering wheel..... 5-46                               |
| 7. Towing button.....6-60   | 14. Seat..... 3-3  |
|   | 15. Fuse box .....9-46                                     |

## INSTRUMENT PANEL OVERVIEW (I)



A0004K001

1. Instrument cluster .....	4-4	14. Ventilate seat button .....	3-34
2. Horn .....	5-46	15. Warmer seat button .....	3-32
3. Ignition switch, Engine Start/ Stop button .....	6-5, 6-8	16. Steering wheel heater button .....	5-46
4. Hazard warning flasher button .....	8-2	17. Ventilation seat button (2 <sup>nd</sup> seat) .....	3-34
5. Infotainment system .....	5-171	18. Warmer seat button (2 <sup>nd</sup> seat) .....	3-32
6. Climate control system .....	5-114, 5-128	19. Rear climate control system ....	5-120, 5-137
7. Shift button .....	6-14	20. Power outlet .....	5-157
8. Auto Hold button .....	6-33	21. AC inverter .....	5-159
9. Integrated memory system .....	5-41	22. Passenger air bag .....	3-62
10. DBC (Downhill Brake Control) button ..	6-43	23. Glove box .....	5-153
11. Parking Safety button .....	7-131	24. Light switch .....	5-98
12. ISG (Idle Stop and Go) button .....	6-54	25. Washer/Wiper switch .....	5-110
13. Parking/View button .....	7-112	26. Wireless charging system .....	5-161

## INSTRUMENT PANEL OVERVIEW (II)

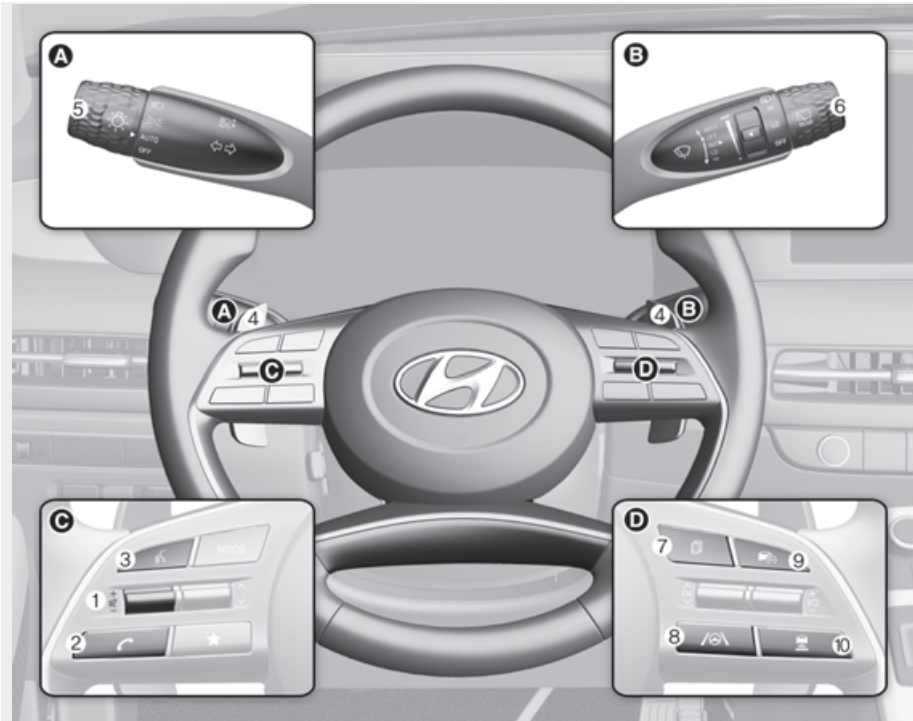

The actual shape may differ from the illustration.

A0005K001

- |   |       |  |       |
|---|-------|--|-------|
| 1. Audio remote control buttons .....   | 5-170 | 6. Wiper and washer control lever.....   | 5-110 |
| 2. Bluetooth® hands-free phone button . | 5-171 | 7. LCD display controls.....             | 4-28  |
| 3. Voice recognition button .....       | 5-171 | 8. Lane Driving Assist button.....       | 7-28  |
| 4. Paddle shifter.....                  | 6-25  | 9. Driving Assist button.....            | 7-71  |
| 5. Lighting control lever .....         | 5-98  | 10. Setting Vehicle Distance button..... | 7-72  |

## ENGINE COMPARTMENT

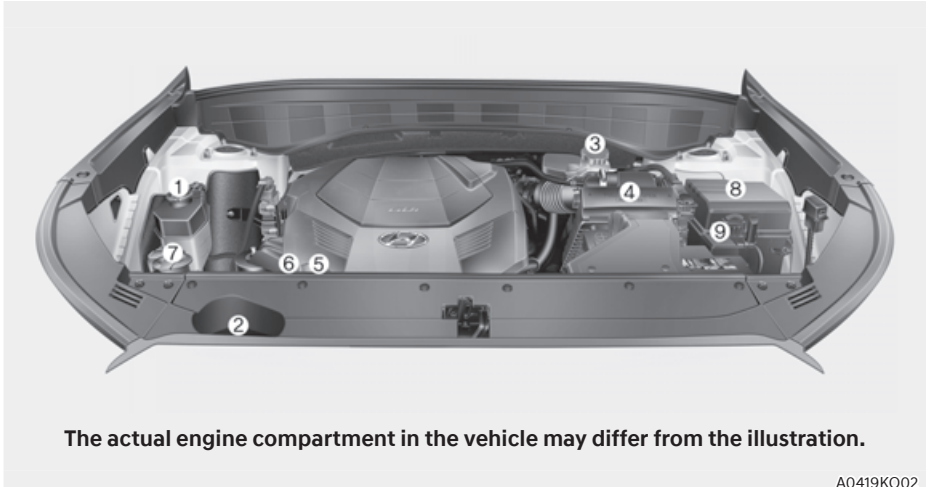

- |                                   |      |  |      |
|-----------------------------------|------|--|------|
| 1. Engine coolant reservoir ..... | 9-3  | 6. Engine oil dipstick .....               | 9-15 |
| 2. Radiator cap.....              | 9-18 | 7. Windshield washer fluid reservoir ..... | 9-22 |
| 3. Brake fluid reservoir .....    | 9-21 | 8. Fuse/relay box .....                    | 9-46 |
| 4. Air cleaner .....              | 9-23 | 9. Battery.....                            | 9-28 |
| 5. Engine oil filler cap .....    | 9-15 |  |      |



## DIMENSIONS

Items		in (mm)
Overall length		196.65 (4,995)
Overall width		77.75 (1,975)
Overall height		68.89 (1,750)
Front tread	245/60 R18	67.24 (1,708)
	245/50 R20	67.24 (1,708)
Rear tread	245/60 R18	67.56 (1,716)
	245/50 R20	67.56 (1,716)
Wheelbase		114.17 (2,900)

## ENGINE

Engine	Displacement cu. in (cc)	Bore x Stroke in. (mm)	No. of cylinders	Firing order
3.8 GDI	230.55 (3,778)	3.78 x 3.43 (96 x 87)	6	1-2-3-4-5-6

## BULB WATTAGE

Light bulb		Bulb type	Wattage	
Front	Headlight	Low	LED	LED
		High, Low beam assist	LED	LED
	Daytime running light/Position lamp		LED	LED
	Turn signal lamp		LED	LED
	Side repeater lamp		LED	LED
	Side marker lamp		LED	LED
Rear	Tail lamp	Type A	P28/8W	28/8
		Type B	LED	LED
	Tail/Stop lamp	Type A	P28/8W	28/8
	Stop lamp	Type B	LED	LED
	Turn signal lamp	Type A	P28/8W	28/8
		Type B	LED	LED
	Side marker lamp		LED	LED
	Revers lamp		W16W	16
	High mounted stop lamp		LED	LED
License plate lamp		W5W	5	
Interior	Map lamp	Type A	W8W	8
		Type B	LED	LED
	Room lamp	Type A	W8W	8
		Type B	LED	LED
	Luggage compartment lamp	Type A	FESTOON	8
		Type B	LED	LED
	Vanity mirror lamp	Type A	5W	5
		Type B	LED	LED
Glove box lamp		LED	LED	

## TIRES AND WHEELS

Items	Tire size	Wheel size	Inflation pressure kPa (psi)				Wheel nut torque Kgf·ft (lbf·ft, N·m)
			Normal load		Maximum load		
			Front	Rear	Front	Rear	
Full size tire	245/60 R18	7.5J X 18	240 (35)		240 (35)		11~13 (79~94, 107~127)
	245/50 R20	7.5J X 20					
Compact spare tire	T155/90 R18	4.0B X 18	420 (60)				

### NOTICE

- Ambient temperature affects tire pressure (about 1 psi (7 kPa) for every 12°F (7°C) change). If colder temperatures are anticipated, it is permissible to increase cold tire inflation pressure by up to 3 psi (20 kPa) over the specification. If extreme temperature changes are expected, be sure to check and adjust tire pressure accordingly.
- Tire inflation pressure decreases with higher elevation, and increases with lower elevation (about 2.4 psi (10 kPa) for every mile (or kilometer) elevation change). Be sure to check and adjust tire pressure accordingly when driving through changing elevations.
- Do not exceed the maximum inflation pressure, as found on the sidewall of the tire(s).



### CAUTION

When replacing tires, ALWAYS use the same size, type, brand, construction and tread pattern supplied with the vehicle. If not, it can damage the related parts or make it work irregularly.

## AIR CONDITIONING SYSTEM

Item	Weight of volume	Classification
Refrigerant oz. (g)	29.98 (850) ± 0.88 (25)	R1234yf
Compressor lubricant oz. (cc)	6.35 (180)	PAG

Contact an authorized HYUNDAI dealer for more details.

## VEHICLE WEIGHT AND LUGGAGE VOLUME

Item		3.8 GDI	
		2WD	AWD
Gross vehicle weight	7 Seater lbs. (kg)	5,732 (2,570)	5,871 (2,660)
	8 Seater lbs. (kg)	5,732 (2,630)	5,871 (2,660)
Luggage volume (SAE) cu. ft (ℓ)		Behind 1st row : 86.4 (2,447) Behind 2st row : 45.8 (1,297) Behind 3st row : 18 (509)	

## RECOMMENDED LUBRICANTS AND CAPACITIES

To help achieve proper engine and powertrain performance and durability, use only lubricants of the proper quality. The correct lubricants also help promote engine efficiency that results in improved fuel economy.

These lubricants and fluids are recommended for use in your vehicle.

Lubricant		Volume	Classification
Engine oil *1 *2 Recommends 		6.86 US qt. (6.5 ℓ)	ACEA A5 or above* 3 / 5W-30 / (SAE Viscosity Number)
Automatic transmission fluid		7.39 US qt. (7.0 ℓ)	MICHANG ATF SP-IV, SK ATF SP-IV, NOCA ATF SP-IV, HYUNDAI genuine ATF SP-IV or other brands meeting the above specification approved by HYUNDAI Motor Co.
Engine coolant	Without trailer	12.44 US qt. (11.79 ℓ)	Mixture of antifreeze and water (Phosphate-based Ethylene glycol coolant for aluminum radiator)
	With trailer	12.65 US qt. (11.98 ℓ)	
Brake fluid *4		As required	SAE J1704 DOT0-4LV, FMVSS116 DOT-4, ISO4925 CLASS-6
Rear differential oil *5		0.73 US qt. (0.7 ℓ)	HYPIO GEAR OIL API GL-5, SAE 75W/85 (SK HCT-5 GEAR OIL 75W/85 or EQUIVALENT)
Transfer case oil (AWD) *5		0.73 US qt. (0.7 ℓ)	
Fuel		18.75 US gal. (71 ℓ)	Refer to “Fuel requirements” in chapter 1.

\*1: Refer to the recommended SAE viscosity numbers on the next page.

\*2: Engine oils labeled Energy Conserving Oil are now available. Along with other additional benefits, they contribute to fuel economy by reducing the amount of fuel necessary to overcome engine friction. Often, these improvements are difficult to measure in everyday driving, but in a year’s time, they can offer significant cost and energy savings.

\*3: Requires <API Latest (or ILSAC Latest) or ACEA A5/B5 Full synthetic> grade engine oil. If a lower grade engine oil (mineral oil including Semi-synthetic) is used, then the engine oil and engine oil filter must be replaced as indicated for severe maintenance conditions.

\*4: To maintain the best braking performance and ABS/ESC performance, we recommend that you use genuine brake fluid that conform to specifications.

\*5: If the rear differential is submerged, have you visit an authorized retailer of HYUNDAI genuine products to replace the differential oil.

## Recommended SAE Viscosity Number

### CAUTION

Always be sure to clean the area around any filler plug, drain plug, or dipstick before checking or draining any lubricant. This is especially important in dusty or sandy areas and when the vehicle is used on unpaved roads. Cleaning the plug and dipstick areas will prevent dirt and grit from entering the engine and other mechanisms that could be damaged.

Engine oil viscosity (thickness) has an effect on fuel economy and cold weather operating (engine start and engine oil flowability). Lower viscosity engine oils can provide better fuel economy and cold weather performance, however, higher viscosity engine oils are required for satisfactory lubrication in hot weather. Using oils of any viscosity other than those recommended could result in engine damage.

When choosing an oil, consider the range of temperature your vehicle will be operated in before the next oil change. Proceed to select the recommended oil viscosity from the chart.

		Temperature Range for SAE Viscosity Numbers									
Temperature	°C	-30	-20	-10	0	10	20	30	40	50	
	(°F)		-10	0	20	40	60	80	100	120	
Gasoline Engine Oil		<b>5W-30</b>									



An engine oil displaying this American Petroleum Institute (API) Certification Mark conforms to the International Lubricant Specification Advisory Committee (ILSAC). It is recommended to only use engine oils that uphold this API Certification Mark.

## VEHICLE IDENTIFICATION NUMBER (VIN) (IF EQUIPPED)

■ Frame number (if equipped)

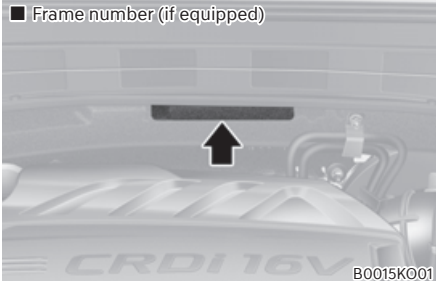

The vehicle identification number (VIN) is the number used in registering your vehicle and in all legal matters pertaining to its ownership, etc.

The number is punched on the engine compartment frame and backside of the engine.

■ VIN label (if equipped)

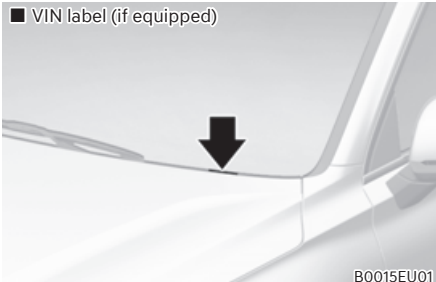

The VIN is also on a plate attached to the top of the left side dashboard. The number on the plate can easily be seen through the windshield from outside.

## VEHICLE CERTIFICATION LABEL



The vehicle certification label attached on the driver's (or front passenger's) side center pillar gives the vehicle identification number (VIN).

## TIRE SPECIFICATION AND PRESSURE LABEL

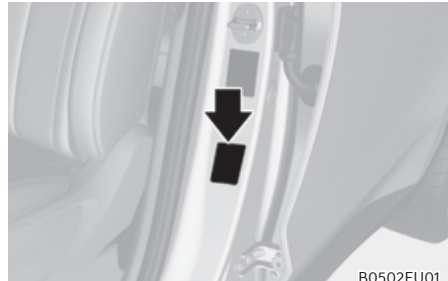

The tires supplied on your new vehicle are chosen to provide the best performance for normal driving. The tire label located on the driver's side center pillar gives the tire pressures recommended for your vehicle.

## ENGINE NUMBER

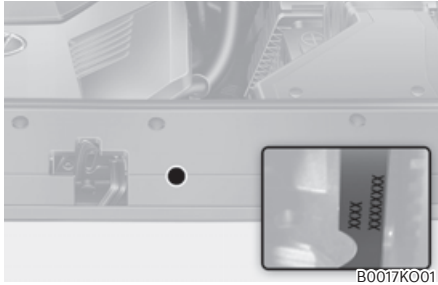

The engine number is stamped on the engine block as shown in the drawing.

## AIR CONDITIONER COMPRESSOR LABEL

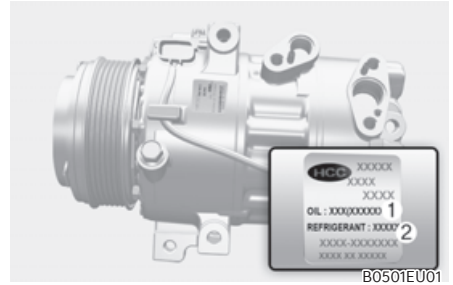

A compressor label informs you the type of compressor your vehicle is equipped with such as model, supplier part number, production number, refrigerant ① and refrigerant oil ②.



## CONSUMER INFORMATION

This consumer information has been prepared in accordance with regulations issued by the National Highway Traffic Safety Administration of the U.S. Department of Transportation. Your HYUNDAI dealer will help answer any questions you may have as you read this information.

HYUNDAI motor vehicles are designed and manufactured to meet or exceed all applicable safety standards.

For your safety, however, we strongly urge you to read and follow all directions in this Owner's Manual, particularly the information under the headings "**NOTICE**", "**CAUTION**" and "**WARNING**".

If, after reading this manual, you have any questions regarding the operation of your vehicle, please contact the Hyundai Customer Care Center.

Hyundai Customer Care  
P.O. Box 20850  
Fountain Valley, CA 92728  
800-633-5151  
[consumeraffairs@hmausa.com](mailto:consumeraffairs@hmausa.com)

Hyundai's Customer Care Center representatives are available Monday through Friday, between the hours of 6:00 AM and 5:00 PM PST and Saturday between 6:30 AM and 3:00 PM PST (English).

For Customer Care assistance in Spanish or Korean, representatives are available Monday through Friday between 6:30 AM and 3:00 PM PST.

## REPORTING SAFETY DEFECTS

If you believe that your vehicle has a defect which could cause a crash or could cause injury or death, you should immediately inform the National Highway Traffic Safety Administration (NHTSA) in addition to notifying HYUNDAI MOTOR AMERICA.

To contact NHTSA, you may call the Vehicle Safety Hotline toll-free at 1-888-327-4236 (TTY: 1-800-424-9153); go to <http://www.safercar.gov>; download the SaferCar mobile application; or write to: Administrator, NHTSA  
1200 New Jersey Ave, SE,  
West Building Washington, D.C. 20590.

You can also obtain other information about motor vehicle safety from <http://www.safercar.gov>.

If NHTSA receives similar complaints, it may open an investigation, and if it finds that a safety defect exists in a group of vehicles, it may order a recall and remedy campaign. However, NHTSA cannot become involved in individual problems between you, your dealer, or HYUNDAI MOTOR AMERICA.

# 3. Seats & Safety System

- Important Safety Precautions .....3-2
  - Always Wear Your Seat Belt ..... 3-2
  - Restrain All Children ..... 3-2
  - Air Bag Hazards ..... 3-2
  - Driver Distraction ..... 3-2
  - Control Your Speed ..... 3-2
  - Keep Your Vehicle in Safe Condition ..... 3-2
- Seats ..... 3-3
  - Safety Precautions ..... 3-6
  - Front Seats ..... 3-7
  - Rear Seats ..... 3-16
  - Head Restraint ..... 3-26
  - Seat Warmers ..... 3-31
  - Air Ventilation Seats ..... 3-34
- Seat Belts ..... 3-36
  - Seat Belt Safety Precautions ..... 3-36
  - Seat Belt Warning Light ..... 3-37
  - Seat Belt Restraint System ..... 3-38
  - Additional Seat Belt Safety Precautions ..... 3-47
  - Care of Seat Belts ..... 3-49
- Child Restraint System (CRS) ..... 3-50
  - Children Always in the Rear ..... 3-50
  - Selecting a Child Restraint System (CRS) ..... 3-51
  - Installing a Child Restraint System (CRS) ..... 3-52
- Air Bag - Supplemental Restraint System ..... 3-60
  - Where Are the Air Bags? ..... 3-62
  - How Does the Air Bags System Operate? ..... 3-66
  - What to Expect After an Air Bag Inflates ..... 3-70
  - Occupant Classification System (OCS) ..... 3-70
  - Why Didn't My Air Bag Go Off in a Collision? ..... 3-76
  - SRS Care ..... 3-81
  - Additional Safety Precautions ..... 3-82
  - Air Bag Warning Labels ..... 3-82

## IMPORTANT SAFETY PRECAUTIONS

You will find many safety precautions and recommendations throughout this section, and throughout this manual. The safety precautions in this section are among the most important.

### Always Wear Your Seat Belt

A seat belt is your best protection in all types of accidents. Air bags are designed to supplement seat belts, not to replace them. So even though your vehicle is equipped with air bags, ALWAYS make sure you and your passengers wear your seat belts, and wear them properly.

### Restrain All Children

All children under age 13 should ride in your vehicle properly restrained in a rear seat, not the front seat. Infants and small children should be restrained in an appropriate Child Restraint System. Larger children should use a booster seat with the lap/shoulder belt until they can use the seat belt properly without a booster seat.

### Air Bag Hazards

While air bags can save lives, they can also cause serious or fatal injuries to occupants who sit too close to them, or who are not properly restrained. Infants, young children, and short adults are at the greatest risk of being injured by an inflating air bag. Follow all instructions and warnings in this manual.

### Driver Distraction

Driver distraction presents a serious and potentially deadly danger, especially for inexperienced drivers. Safety should be the first concern when behind the wheel and drivers need to be aware of the wide array of potential distractions, such as drowsiness, reaching for objects, eating, personal grooming, other passengers, and using mobile phones.

Drivers can become distracted when they take their eyes and attention off the road or their hands off the wheel to focus on activities other than driving. To reduce your risk of distraction and an accident:

- Set up your mobile devices (for example, MP3 players, phones, navigation units, etc.) ONLY when your vehicle is parked or safely stopped.
- ONLY use your mobile device when allowed by laws and conditions permit safe use. NEVER text or email while driving. Most countries have laws prohibiting drivers from texting. Some countries and cities also prohibit drivers from using handheld phones.
- NEVER let the use of a mobile device distract you from driving. You have a responsibility to your passengers and others on the road to always drive safely, with your hands on the wheel as well as your eyes and attention on the road.

### Control Your Speed

Excessive speed is a major factor in crash injuries and deaths. Generally, the higher the speed, the greater the risk, but serious injuries can also occur at lower speeds. Never drive faster than is safe for current conditions, regardless of the maximum speed posted.

### Keep Your Vehicle in Safe Condition

Having a tire blowout or a mechanical failure can be extremely hazardous. To reduce the possibility of such problems, check your tire pressures and condition frequently, and perform all regularly scheduled maintenance.

## SEATS

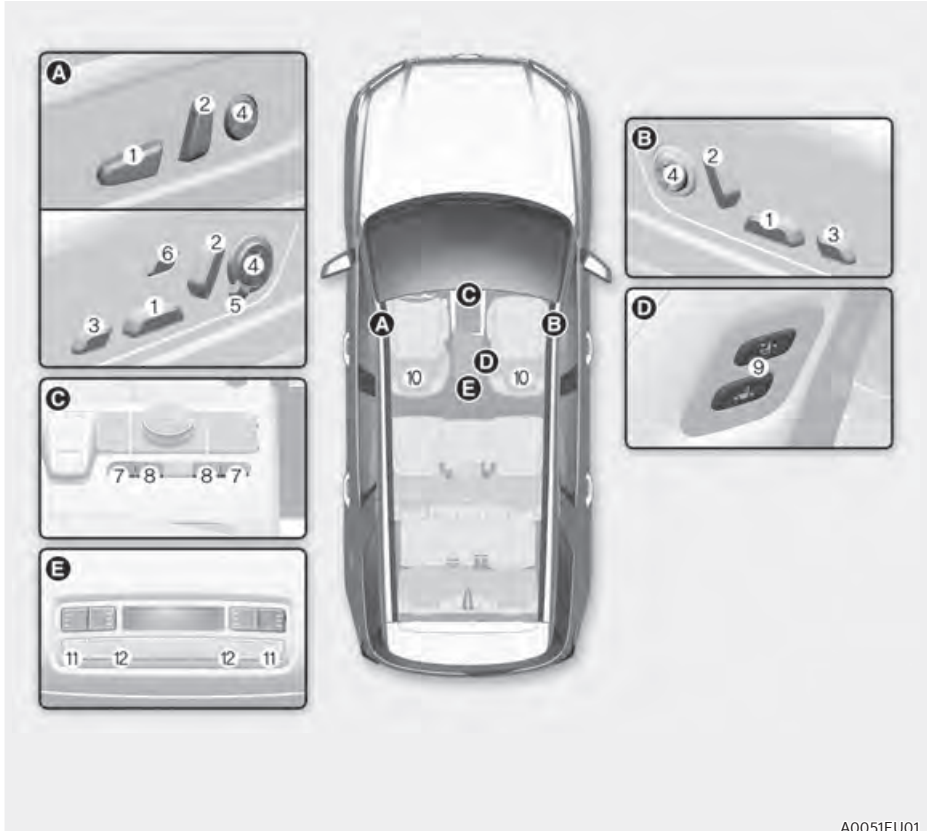

A0051EU01

**Front seat**

- ① Seat sliding forward or rearward /  
Seat cushion tilt /  
Seat cushion height
- ② Seatback angle
- ③ Leg support (if equipped)
- ④ Lumbar support
- ⑤ Seatback bolster (if equipped)
- ⑥ Comfortable stretch (if equipped)
- ⑦ Air ventilation seat
- ⑧ Seat warmer
- ⑨ Walk-in seat switch
- ⑩ Head restraint
- ⑪ Rear air ventilation seat
- ⑫ Rear seat warmer

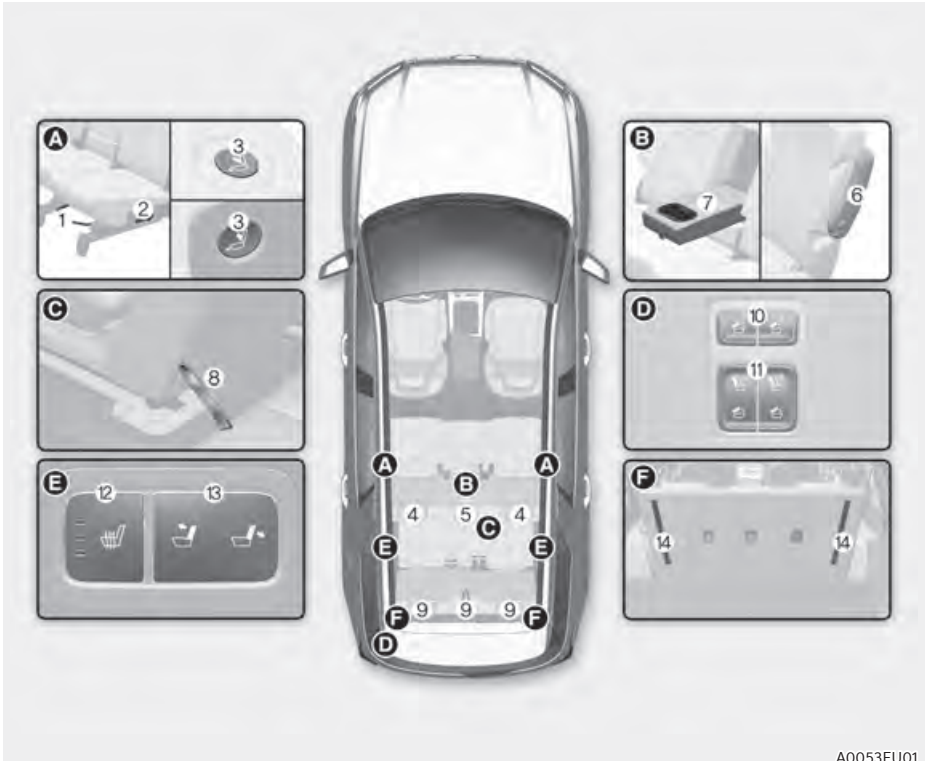

A0053EU01

**Rear seat**

- ① Seat sliding forward or rearward (2<sup>nd</sup> row seat)
- ② Seatback angel/Seat folding (2<sup>nd</sup> row seat)
- ③ Walk-in switch (2<sup>nd</sup> row seat)
- ④ Headrest restraint (2<sup>nd</sup> row seat)
- ⑤ Headrest restraint (2<sup>nd</sup> center seat, 8-seater)
- ⑥ Armrest (7-seater)
- ⑦ Armrest (8-seater)
- ⑧ Walk-in strap (for emergency, 2<sup>nd</sup> row seat)
- ⑨ Headrest restraint (3<sup>rd</sup> row seat)
- ⑩ Seat folding switch (2<sup>nd</sup> row seat) (if equipped)
- ⑪ Seat folding switch (3<sup>rd</sup> row seat) (if equipped)
- ⑫ Seat warmer switch (3<sup>rd</sup> row seat) (if equipped)
- ⑬ Seatback angle (3<sup>rd</sup> row seat) (if equipped)
- ⑭ Seat folding strap (3<sup>rd</sup> row seat) (if equipped)

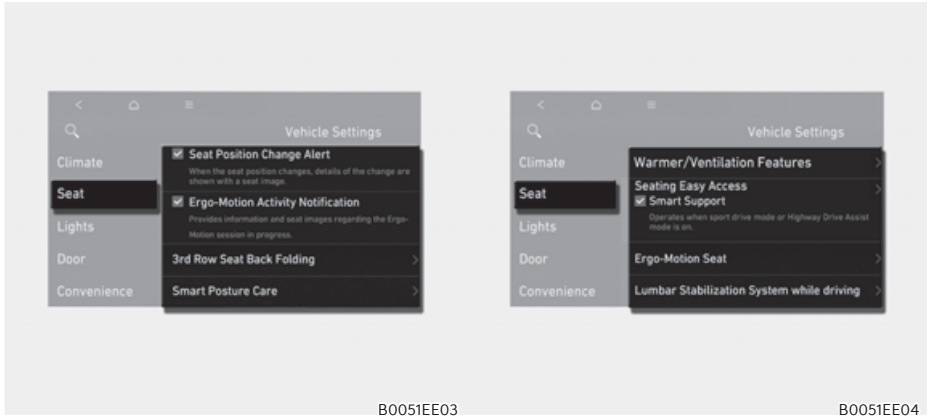

B0051EE03

B0051EE04

### Seat Setting

Select 'Setup → Vehicle → Seat' from the Settings menu in the infotainment system screen, you may use various convenience functions.

- Seat position change alert : Seat change information is displayed.
- Ergo-motion seat alert: Ergo-Motion seat is operated, information is displayed with the seat image.
- Warmer/Ventilation Features
  - Auto. Controls That Use Climate Control Settings (for driver's seat) : The seat temperature is automatically controlled.
- Seating easy access
  - Steering wheel easy access : Moves the steering wheel when the driver enters or leaves the vehicle.
  - Driver seat easy access : The distance (Normal/Extended/Off) the seat automatically moves when the driver enters or leaves the vehicle may be selected.
- Smart support: The driver's seat bolster is increased when SPORT mode is selected or when driving at high speed.
- Ergo-motion seat
  - Comfortable stretch : The operation intensity and operation time for Comfortable Stretch may be selected.
  - Smart posture assist : The seat is adjusted to assist the driver's posture after driving for an hour.

The infotainment system may change after software updates. For more information, refer to the user's manual provided in the infotainment system and the quick reference guide.

## Information

The information provided may differ depending on which functions are applicable to your vehicle.

## Safety Precautions

Adjusting the seats so that you are sitting in a safe and comfortable position plays an important role for the safety of the driver and passengers, as much as seat belts and air bags when in an accident.

## WARNING

**Do not use a cushion that reduces friction between the seat and the passenger. The passenger's hips may slide under the lap portion of the seat belt during an accident or a sudden stop.**

**Serious or fatal internal injuries could result because the seat belt cannot operate properly.**

## *Air bags*

You can take steps to reduce the risk of being injured by an inflating air bag. Sitting too close to an air bag greatly increases the risk of injury in the event the air bag inflates. The National Highway Traffic Safety Administration (NHTSA) recommends that drivers allow at least 10 inches (25 cm) between the center of the steering wheel and their chest.

## WARNING

To reduce the risk of serious injury or death from an inflating air bag, take the following precautions:

- **Adjust the driver's seat as far to the rear as possible while maintaining the ability to control the vehicle.**
- **Adjust the front passenger seat as far to the rear as possible.**
- **Hold the steering wheel by the rim with your hands at the 9 o'clock and 3 o'clock positions to minimize the risk of injuries to your hands and arms.**
- **NEVER place anything or anyone between you and the air bag.**
- **Do not allow the front passenger to place feet or legs on the dashboard to minimize the risk of leg injuries.**

## *Seat belts*

Always fasten your seat belt before starting any trip. At all times, passengers should sit upright and be properly restrained. Infants and small children must be restrained in appropriate Child Restraint Systems. Children who have outgrown a booster seat and adults must be restrained using the seat belts.

## WARNING

**Take the following precautions when adjusting your seat belt:**

- **NEVER use one seat belt for more than one occupant.**
- **Always position the seatback upright with the lap portion of the seat belt snug and low across the hips.**
- **NEVER allow children or small infants to ride on a passenger's lap.**
- **Do not route the seat belt across your neck, across sharp edges, or reroute the shoulder strap away from your body.**
- **Do not allow the seat belt to become caught or jammed.**



## Front Seats

### WARNING

Take the following precautions when adjusting your seat:

- **NEVER** attempt to adjust the seat while the vehicle is moving. The seat could respond with unexpected movement and may cause loss of vehicle control resulting in an accident.
- Do not place anything under the front seats. Loose objects in the driver's foot area could interfere with the operation of the foot pedals, causing an accident.
- Do not allow anything to interfere with the normal position and proper locking of the seatback.
- Do not place a cigarette lighter on the floor or seat. When you operate the seat, gas may exit out of the lighter causing a fire.
- Use extreme caution when picking up small objects trapped under the seats or between the seat and the center console. Your hands might be cut or injured by the sharp edges of the seat mechanism.
- If there are occupants in the rear seats, be careful while adjusting the front seat position.
- Make sure that the seat is locked in place after the adjustment. If not, the seat might move unexpectedly resulting in an accident.

### CAUTION

To prevent injury:

- Do not adjust your seat while wearing your seat belt. Moving the seat cushion forward may cause strong pressure on your abdomen.
- Do not allow your hands or fingers to get caught in the seat mechanisms while the seat is moving.

### WARNING

**NEVER** allow children in the vehicle unattended. The power seats are operable when the vehicle is turned off.

### **NOTICE**

To prevent damage to the seats:

- Always stop adjusting the seats when the seat has been adjusted as far forward or rearward as possible.
- Do not adjust the seats longer than necessary when the vehicle is turned off. This may result in unnecessary battery drain.
- Do not operate two or more seats at the same time. This may result in an electrical malfunction.

### Manual adjustment (if equipped)

The front seat can be adjusted by using the levers located on the outside of the seat cushion. Before driving, adjust the seat to the proper position so that you can easily control the steering wheel, foot pedals and controls on the instrument panel.



### Forward and rearward adjustment

To move the seat forward or rearward:

1. Pull up the seat slide adjustment lever and hold it.
2. Slide the seat to the position you desire.
3. Release the lever and make sure the seat is locked in place. Move forward and rearward without using the lever. If the seat moves, it is not locked properly.



### Seatback angle

To recline the seatback:

1. Lean forward slightly and lift up the seatback lever.
2. Carefully lean back on the seat and adjust the seatback to the position you desire.
3. Release the lever and make sure the seatback is locked in place. (The lever **MUST** return to its original position for the seatback to lock.)

### Reclining seatback

Sitting in a reclined position when the vehicle is in motion can be dangerous. Even when buckled up, the protection of your restraint system (seat belts and air bags) is greatly reduced by reclining your seatback.

### **WARNING**

**NEVER** ride with a reclined seatback when the vehicle is moving.

**Riding with a reclined seatback increases your chance of serious or fatal injuries in the event of a collision or sudden stop.**

**Drivers and passengers should ALWAYS sit well back in their seats, properly belted, and with the seatbacks upright.**

Seat belts must be snug against your hips and chest to work properly. When the seatback is reclined, the shoulder belt cannot do its job because it will not be snug against your chest. Instead, it will be in front of you. During an accident, you could be thrown into the seat belt, causing neck or other injuries.

The more the seatback is reclined, the greater chance the passenger's hips will slide under the lap belt or the passenger's neck will strike the shoulder belt.



B0052K004

### Seat cushion height

To change the height of the seat cushion:

- Push down the lever several times, to lower the seat cushion.
- Pull up the lever several times, to raise the seat cushion.

### Power adjustment (if equipped)

The front seat can be adjusted by using the control switches located on the outside of the seat cushion. Before driving, adjust the seat to the proper position so that you can easily control the steering wheel, foot pedals and controls on the instrument panel.

### WARNING

**NEVER** allow children in the vehicle unattended. The power seats are operable when the vehicle is turned off.

### **NOTICE**

To prevent damage to the seats:

- Always stop adjusting the seats when the seat has moved as far forward or rearward as possible.
- Do not adjust the seats for longer than necessary when the vehicle is turned off. This may result in unnecessary battery drain.
- Do not operate two or more seats at the same time. This may result in an electrical malfunction.



### Forward and rearward adjustment

To move the seat forward or rearward:

1. Push the control switch forward or rearward.
2. Release the switch once the seat reaches the desired position.



### Seat cushion tilt ①

To change the angle of the front part of the seat cushion:

Push the front portion of the control switch up to raise or down to lower the front part of the seat cushion.

Release the switch once the seat reaches the desired position.

### Seat cushion height ②

To change the height of the seat cushion:

Push the rear portion of the control switch up to raise or down to lower the height of the seat cushion.

Release the switch once the seat reaches the desired position.



### Seatback angle adjustment

To recline the seatback:

1. Push the control switch forward or rearward.
2. Release the switch once the seatback reaches the desired position.

### Reclining seatback

Sitting in a reclined position when the vehicle is in motion can be dangerous. Even when buckled up, the protections of your restraint system (seat belts and air bags) is greatly reduced by reclining your seatback.



### **WARNING**

**NEVER** ride with a reclined seatback when the vehicle is moving.

**Riding with a reclined seatback increases your chance of serious or fatal injuries in the event of a collision or sudden stop.**

**Driver and passengers should ALWAYS sit well back in their seats, properly belted, and with the seatbacks upright.**

Seat belts must be snug against your hips and chest to work properly. When the seatback is reclined, the shoulder belt cannot do its job because it will not be snug against your chest. Instead, it will be in front of you. During an accident, you could be thrown into the seat belt, causing neck or other injuries.

The more the seatback is reclined, the greater chance the passenger's hips will slide under the lap belt or the passenger's neck will strike the shoulder belt.



### Seat cushion extension adjustment (for driver's seat, if equipped)

To move the front part of the cushion forward or rearward:

1. Push the control switch forward or rearward.
2. Release the switch once the seat cushion reaches the desired length.

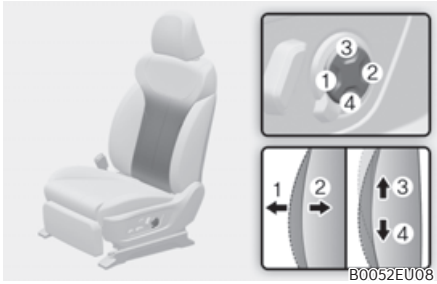

**Lumbar support (2way) (if equipped)**

To adjust the lumbar support:

Press the front portion of the switch ① to increase support or the rear portion of the switch ② to decrease support.

**Lumbar support (4way) (for driver's seat) (if equipped)**

To adjust the lumbar support:

1. Press the front portion of the switch ① to increase support or the rear portion of the switch ② to decrease support.
2. Press switch ③ or ④ to move the support position up or down.
3. Release the switch once the lumbar support reaches the desired position.



**Seat bolster adjustment (for driver's seat) (if equipped)**

To adjust seat bolster:

1. Push the adjustment lever clockwise, the seatback bolster will be adjusted inward. Push the switch counterclockwise, the seatback bolster will be adjusted outward.
2. Release the lever once the bolster reaches the desired position.

### Leg support adjustment (if equipped)

Place your leg on the leg support and adjust its angle to relax.



- Control switch

Slide the leg support switch diagonally upward or downward to adjust the angle.



#### CAUTION

Do not sit or place heavy objects on the calf support. It may damage the system.



#### WARNING

- When lowering or raising the calf support, be careful not to have your hands or legs caught under the front seats or other surrounding parts of the calf support. Unexpected injuries may occur.
- Do not allow children to adjust the switch. Unexpected injuries may occur.

### Ergo-motion seat (if equipped)



Select 'Setup → Vehicle → Seat → Ergo-Motion Seat' from the infotainment system's Settings menu to select and set up supplemental functions for the driver.



#### WARNING

Before actually using each function, try the functions with the vehicle parked.

### Comfortable stretch

Comfortable stretch is a function that helps relieve fatigue of the driver's pelvis and lower back due to driving.



Every time you press the button, you may select a mode or turn off the function in the following order.

- Pelvic stretching: The cushion portion moves, helping the left and right movement of the pelvis.
- Lumbar stretching: The seatback portion moves, helping back and forth movement of the lower back.
- Whole Body stretching: The cushion and seatback moves in sequence, helping the whole body reduce fatigue.
- OFF: Turns off Comfortable Stretch.

Also, you can change the operation intensity and operation time from the Settings menu in the infotainment system screen.

- Intensity: Setup → Vehicle → Seat → Ergo-Motion Seat → Comfortable Stretch → Strong/Normal
- Time: Setup → Vehicle → Seat → Ergo-Motion Seat → Comfortable Stretch → Operational Time → Short (10min.)/Normal(15min.)/Long(20min.)

### Posture assist

After driving for an hour, Posture Assist automatically adjusts the pelvis and back portion of the driver's seat to assist the driver's posture.

You can activate or deactivate Posture Assist function from the Settings menu in the infotainment system screen. Select:

- Setup → Vehicle → Seat → Ergo-Motion Seat → Posture Assist

### Smart support

The driver's seat bolster support increases and the part of cushion support goes down when SPORT mode is selected for Drive Mode.

When the Drive Mode other than Sport mode is selected, the support of the seat bolster is increased at high speed (over 80 mph (130 km/h)).

When the vehicle slows down, it returns to the previous position (below 68 mph (110 km/h)).

You can activate or deactivate Posture Assist function from the Settings menu in the infotainment system screen. Select:

- Setup → Vehicle → Seat → Ergo-Motion Seat → Smart Support

### Information

**The infotainment system may change after software updates. For more information, refer to the user's manual provided in the infotainment system and the quick reference guide.**



### Walk-in switch



The rear seat passenger may use the switches to control the front passenger seat.

- Sliding forward or rearward:  
Press the switch ① or ② to move the front passenger seat forward or rearward.
- Seatback angle:  
Press the switch ③ or ④ to recline the front passenger seatback forward or rearward.

### Seatback pocket

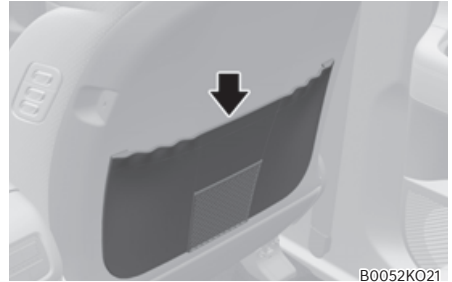

The seatback pocket is provided on the back of the front seatbacks.



### CAUTION

**Do not put heavy or sharp objects in the seatback pockets. In an accident they could come loose from the pocket and injure occupants.**

## Rear Seats



### WARNING

Take the following precautions:

- **Adjusting the seats**
  - **NEVER** attempt to adjust the seat while the vehicle is moving. The seat may suddenly move and may injure the passenger.
  - Make sure that the seat is locked in place after the adjustment. If not, the seat might move unexpectedly resulting in an accident.
- **Folding the seats**
  - Do not fold the seatback when the seat is occupied (for example, passenger, pets or luggage). It may injure the passenger or pet, or damage the luggage.
  - Never allow passengers to sit on top of the folded down seatback while the vehicle is moving. This is not a proper seating position and no seat belts are available for use. This could result in serious injury or death in case of an accident or sudden stop.
  - Objects carried on the folded down seatback should not extend higher than the top of the front seatbacks. This could allow cargo to slide forward and cause injury or damage during sudden stops.
  - When returning the rear seatback from a folded to an upright position, hold the seatback and return it slowly. Ensure that the seatback is completely locked into its upright position by pushing on the top of the seatback. In an accident or sudden stop, the unlocked seatback could allow cargo to move forward with great force and enter the passenger compartment, which could result in serious injury or death.

- **Loading cargo**
  - Make sure the engine is off, the gear shifted to P (Park), and the parking brake is securely applied whenever loading or unloading cargo. Failure to take these steps may allow the vehicle to move if the shift button or shift dial is inadvertently pressed or rotated to another position.
  - When cargo is loaded through the rear passenger seats, ensure the cargo is properly secured to prevent it from moving while driving.
- Do not place objects in the rear seats, since they cannot be properly secured and may hit vehicle occupants in a collision causing serious injury or death.



### CAUTION

Do not allow your hands or fingers to get caught in the seat mechanisms while adjusting the seats.

### NOTICE

To prevent damage to the vehicle:

- **Rear seat belts**

Before folding the seatback, insert the seat belt buckle in the holder between the seatback and cushion. And insert the seat belt webbing in the guide to prevent the seat belt from being damaged.
- **Cargo**

Be careful when loading cargo through the rear passenger seats to prevent damage to the vehicle interior.

 **WARNING**

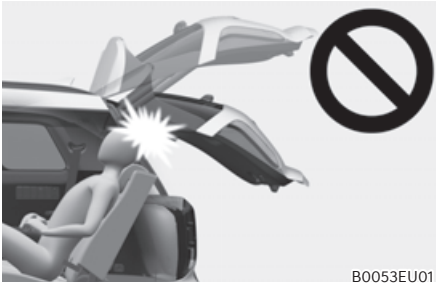

Be careful when closing the liftgate with passenger's seated on the third row seat. If the passenger's head is not properly against an adjusted head restraint or a tall person is seated, the liftgate may hit the passenger's head, which could cause injury.

**Manual adjustment (second row)**

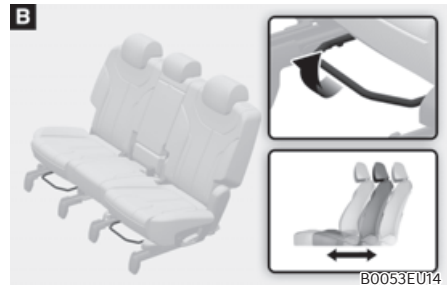

Ⓐ: 7-seater

Ⓑ: 8-seater

**Forward and rearward**

To move the seat forward or rearward:

1. Pull the seat slide adjustment lever up and hold it.
2. Slide the seat to the position you desire.
3. Release the lever and make sure the seat is locked in place.

If equipped with 7-seater or 8-seater, the central seat moves together with the drivers side second row seat.



Ⓐ: 7-seater

Ⓑ: 8-seater

## Seatback angle

To recline the seatback:

1. Pull up the seatback recline lever.
2. Hold the lever and adjust the seatback of the seat to the position you desire.
3. Release the lever and make sure the seatback is locked in place. The lever **MUST** return to its original position for the seatback to lock.

If equipped with 7-seater or 8-seater, the central seat moves together with the drivers side second row seat.

- \* The seatbacks can be folded with the seatback recline lever.

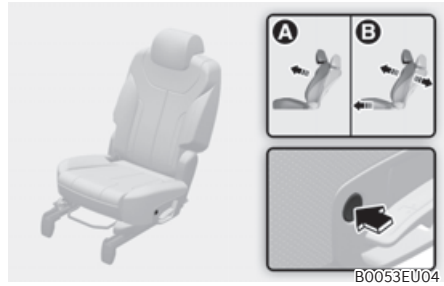

## Seatback folding / Walk-in function

- The seatback will fold and the seat will slightly move forward, if the switch is pressed.
- The function operates when the gear is in P (Park) with the door open.
- While the seatback folding or walk-in function is operating, if the switch is pressed, the seat will stop moving. If the switch is pressed again, the seat will continue the adjustment.
- While the seatback folding or walk-in function is operating, if the engine is started, the seat will stop moving momentarily. If the engine starts, the seat will continue the adjustment.

If equipped with 7-seater or 8-seater, the central seat moves together with the drivers side second row seat.

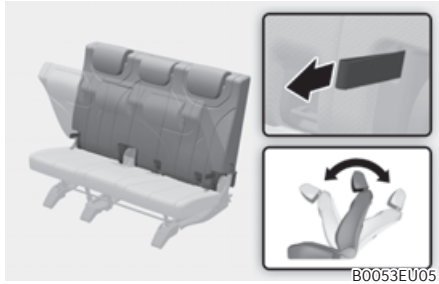
**Manual adjustment (third row)****Seatback angle**

To recline the seatback:

1. Pull the seatback recline strap.
2. Hold the strap and adjust the seatback angle to the position you desire.
3. Release the strap and make sure the seatback is locked in place. The strap **MUST** return to its original position for the seatback to lock.

**Power adjustment (third row)****Seatback angle**

Press the switch (🪑) or (🪑) to adjust the seatback angle.

When the seatback is folded, press the switch (🪑), the seatback will automatically unfold.

### Walk-in seat (2<sup>nd</sup> row seat)

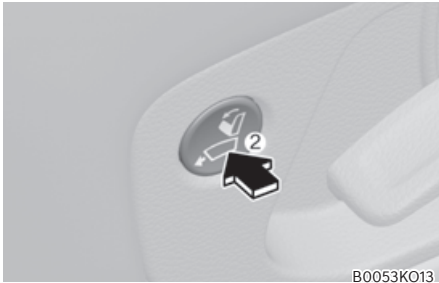
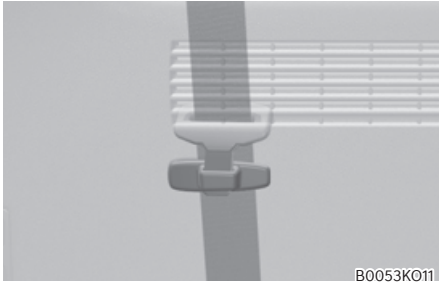

To get in or out of the 3<sup>rd</sup> row seat,

1. Routing the seat belt webbing through the rear seat belt guide clip. After inserting the seat belt, tighten the belt webbing by pulling it up.
2. Push the walk-in switch located in upper part ① of 2<sup>nd</sup> row seat or side part ② of 2<sup>nd</sup> row seat.
3. The 2<sup>nd</sup> row seatback will be folded and push the seat to the farthest forward position.

After getting in or out, slide the 2<sup>nd</sup> row seat to the farthest rearward position and pull the seatback firmly backward until it clicks into place. Make sure that the seat is locked in place.

### **WARNING**

**Never attempt to adjust while the vehicle is moving or the 2<sup>nd</sup> row seat is occupied as the seat may suddenly move and cause the passenger on the seat to be injured.**

## WARNING



- If the walk-in switch does not work, pull the strap ① located on the lower left side of the seat. Then you can move the 2<sup>nd</sup> row seat forward.  
(7 passenger vehicle)
  - Left seat : lower right side
  - Right seat : lower left side
 (8 passenger vehicle)
  - Right seat : lower left side)
- Never attempt to pull the strap ① while the 2<sup>nd</sup> row seat is occupied as the seat may suddenly move and cause the passenger on the seat to be injured. Use only the strap when the walk-in switch does not work.

## Folding the rear seats

The rear seatbacks can be folded to facilitate carrying long items or to increase the luggage capacity of the vehicle.

Before folding the rear seats, lower the head restraint to the lowest position and store the seat belt buckles in the holders and webbing in the guide.

If you want to use the rear seats, make sure the seatbacks are upright and securely locked in place. Always return the head restraint and seatbelt to its proper position.

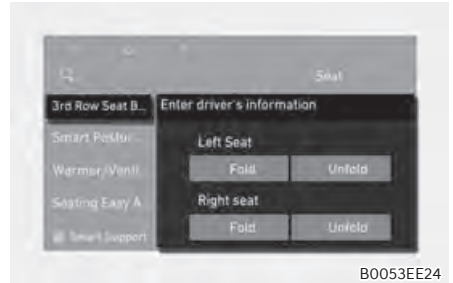

### Third row seatback folding (if equipped)

Second and third row seatback folding can be done from the Settings menu in the infotainment system screen. Select:

- Setup → Vehicle → Seat → 3<sup>rd</sup> Row Seat Back Folding

## Information

The infotainment system may change after software updates. For more information, refer to the user's manual provided in the infotainment system and the quick reference guide.

### Rear seatback manual folding

To fold down the rear seatback:

1. Set the front seatback to the upright position and if necessary, slide the front seat forward.
2. Lower the rear head restraints to the lowest position.

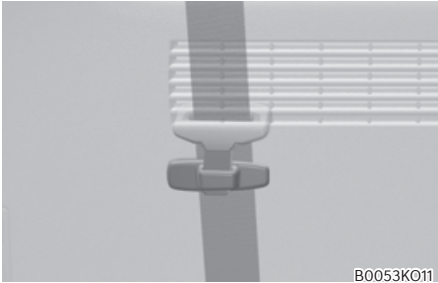

3. Route the seat belt webbing through the rear seat belt guides to prevent the belts from being trapped behind or under the seats.

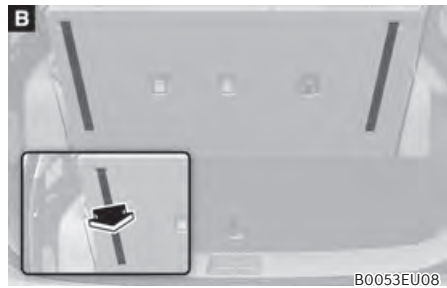
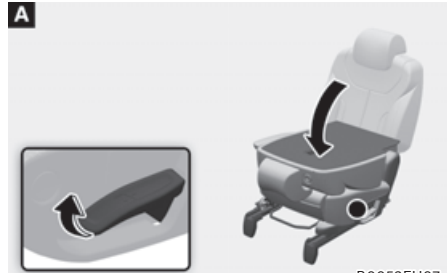

- Ⓐ: 2<sup>nd</sup> row seat
- Ⓑ: 3<sup>rd</sup> row seat

4. Pull on the seatback folding lever (2<sup>nd</sup> row seat) or pull the strap backward (3<sup>rd</sup> row seat), then fold the seat toward the front of the vehicle. When you return the seatback to its upright position, always be sure it has locked into position by pushing on the top of the seatback.



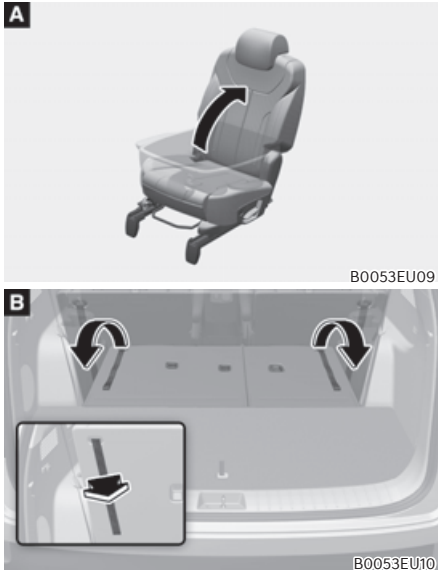

- Ⓐ: 2<sup>nd</sup> row seat  
 Ⓑ: 3<sup>rd</sup> row seat

- To use the rear seat, lift and unfold the seatback to the upright position by pulling up the folding lever (2<sup>nd</sup> row seat) or pulling strap backward (3<sup>rd</sup> row seat). Push the seatback firmly until it clicks into place. Make sure the seatback is locked in place.
- Return the rear seat belt to the proper position.

### WARNING

When returning the rear seatback from a folded to an upright position, hold the seatback and return it slowly. Ensure that the seatback is completely locked into its upright position by pushing on the top of the seatback. In an accident or sudden stop, the unlocked seatback could allow cargo to move forward with great force and enter the passenger compartment, which could result in serious injury or death.

### WARNING

Do not place objects in the rear seats, since they cannot be properly secured and may hit vehicle occupants in a collision causing serious injury or death.

### WARNING

Make sure the engine is off, the shift button is in P (Park), and the parking brake is securely applied whenever loading or unloading cargo. Failure to take these steps may allow the vehicle to move if the shift button is inadvertently shifted to another position.

### CAUTION

- Be careful when loading cargo through the rear passenger seats to prevent damage to the vehicle interior.
- When cargo is loaded through the rear passenger seats, ensure the cargo is properly secured to prevent it from moving while driving.
- Unsecured cargo in the passenger compartment can cause damage to the vehicle or injury to its occupants.

**Seatback remote folding/unfolding (luggage compartment)**

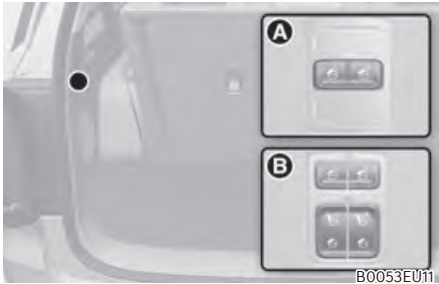

- The function operates when the gear is in P (Park) with the door open.
- While the seatback is folding or unfolding, if the switch is pressed, the seat will stop moving. If the switch is pressed again, the seat will continue the adjustment.
- While the seatback is folding or unfolding, if the engine is started, the seat will stop moving momentarily. If the engine starts, the seat will continue the adjustment.

	Switch type	Seat adjustment
Type A		Press  switch or  switch, the second row left or right seatback will fold.
Type B		Press  switch or  switch, the second row left or right seatback will fold. Press  switch or  switch, the third row left or right seatback will fold. If the switch is pressed again, the seatback will unfold.

The 3<sup>rd</sup> row seat that is remotely folded or unfolded, is controlled only when the shift button is in “P” with Start ON, or the shift button is in “N” and the parking brake is in “ON.”

However, the seat is controlled at any condition in Start OFF state. When the vehicle moves or shifts while the seat is being controlled, the seat may stop operation.

When you press the switch once more while folding and unfolding the seat, operation stops. When you press the switch again, the operation resumes.

With the seat folded, when you press the angle adjusting switch, the seat is unfolded.



## CAUTION

Without starting the engine, the 3<sup>rd</sup> row seat can be folded or unfolded. When this is attempted more than 10 times, the battery may discharge prematurely.

Do not apply excessive force to the 3<sup>rd</sup> row seat while in operation. It may damage the seat.

When you operate the seat over 5 times with no rest, the electric motor may be overloaded. In this case, the seat changes to overheat prevention mode. Then you cannot operate the seat by pressing the switch. Leave the seat for over 1 minute for later operation.

### *Detection of object caught*

While folding or unfolding the 3<sup>rd</sup> row seat, when a consistent force is detected, the seat returns to its original position or stops operation.

However, this function may not work when the detected resistance is below a specific level or the seat is almost folded or unfolded. When a strong impact is applied to the seat, the object detection function may be activated even if no obstacle is present.

When any object caught is detected multiple times while operating the seat once, folding and unfolding are repeated consecutively and then the operation may stop. In this case, check that any object is caught and then operate the switch again to check for abnormality.

When the object detection is enabled, the angle of the seat back may be changed. When you operate the seat once by pressing the folding button, the angle of the seat back is reset.



## WARNING

Do not place any part of your body or anything in the operating area to intentionally check the detection of any object caught.

For safety, when folding or unfolding the 3<sup>rd</sup> row seat, make sure that there is no part of body or object. To prevent damage to the seatbelt, insert it into its holder and store it in the retractor inside a seat.

When the child restraint system (CRS) is installed on the 3<sup>rd</sup> row seat, remove the CRS and then operate the seat.

When there is any object on the cushion of the 3<sup>rd</sup> row seat, remove it and then operate the seat.

To avoid interference with a front seat, keep the backrest of the front seat straight and move it forward for smooth operation.

### Armrest (Second row seat)

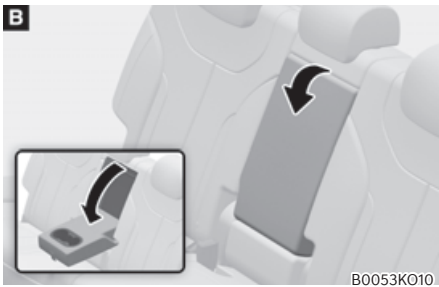

- Ⓐ: 7-seater
- Ⓑ: 8-seater

The armrest is located in the center of the rear seat. Pull the armrest down from the seatback to use it.

To adjust the armrest at a convenient angle, lower the armrest from the highest position to the lowest position, and lift it up to fixed on it.

Since it cannot be adjusted downward after fixing, lift the armrest slightly more than the highest position, then lower it to the lowest position and adjust while lift it up.

### Head Restraint

The vehicle's front and rear seats have adjustable head restraints. The head restraints provide comfort for passengers, but more importantly they are designed to help protect passengers from whiplash and other neck and spinal injuries during an accident, especially in a rear impact collision.

#### **WARNING**

To help reduce the risk of serious injury or death in an accident, take the following precautions when adjusting your head restraints:

- Always properly adjust the head restraints for all passengers **BEFORE** starting the vehicle.
- **NEVER** let anyone ride in a seat with the head restraint removed or reversed.

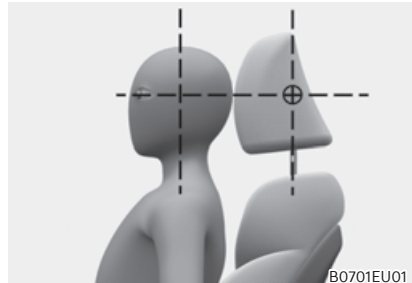

**Adjust the head restraints so the middle of the head restraint is at the same height as the height of the top of the eyes.**

- **NEVER** adjust the head restraint position of the driver's seat when the vehicle is in motion.
- Adjust the head restraint as close to the passenger's head as possible. Do not use a seat cushion that holds the body away from the seatback.
- Make sure the head restraint locks into position after adjusting it.

**WARNING**

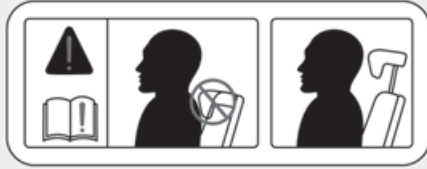

B0053K024

When sitting on the rear seat, do not adjust the height of the head restraint to the lowest position.

**CAUTION**

When there is no occupant in the rear seats, adjust the height of the head restraint to the lowest position. The rear seat head restraint can reduce the visibility of the rear area.

**NOTICE**

To prevent damage, NEVER hit or pull on the head restraints.

**Front seat head restraints**

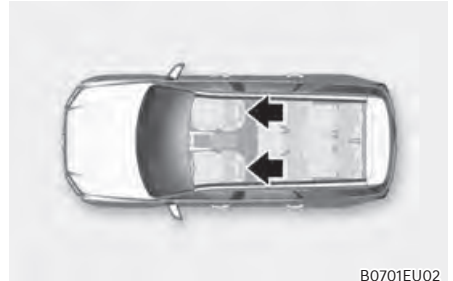

B0701EU02

The driver's and front passenger's seats are equipped with adjustable head restraints for the passengers safety and comfort.

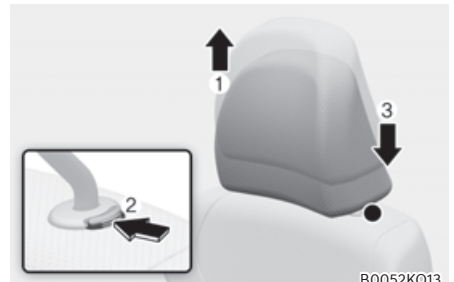

B0052K013

**Adjusting the height up and down**

To raise the head restraint:

1. Pull it up to the desired position ①.

To lower the head restraint:

1. Push and hold the release button ② on the head restraint support.
2. Lower the head restraint to the desired position ③.

**NOTICE**



If you recline the seatback towards the front with the head restraint and seat cushion raised, the head restraint may come in contact with the sunvisor or other parts of the vehicle.

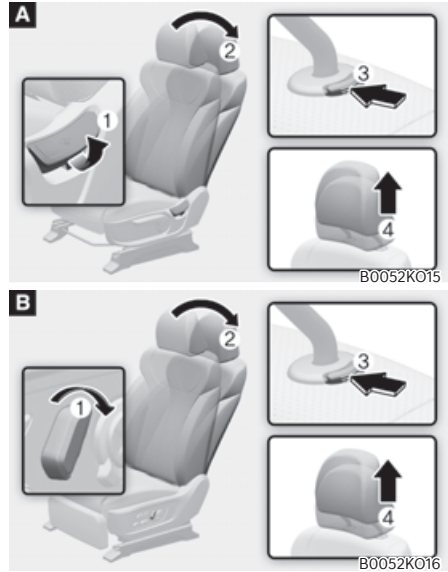

- Ⓐ: Manual seat
- Ⓑ: Power seat

**Removal/Reinstall**

To remove the head restraint:

1. Recline the seatback ② with the seatback angle switch ①.
2. Raise the head restraint as far as it can go.
3. Press the head restraint release button ③ while pulling the head restraint up ④.

 **WARNING**

**NEVER** allow anyone to travel in a seat with the head restraint removed.

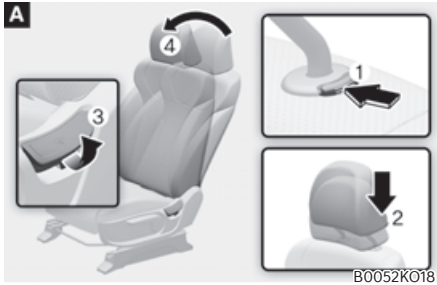

B0052KO18



B0052KO19

Ⓐ: Manual seat

Ⓑ: Power seat

To reinstall the head restraint :

1. Recline the seatback.
2. Put the head restraint poles ② into the holes while pressing the release button ①.
3. Adjust the head restraint to the appropriate height.
4. Recline the seatback ④ with the seatback angle switch ③.

## WARNING

**Always make sure the head restraint locks into position after reinstalling and adjusting it properly.**

## Rear seat head restraints



B0701EU03

\*: If equipped

The rear seats are equipped with head restraints in all the seating positions for the passenger's safety and comfort.

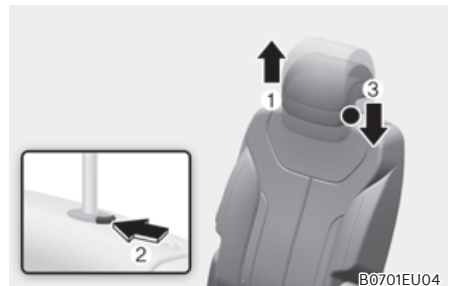

B0701EU04

## Adjusting the height up and down

To raise the head restraint:

1. Pull it up to the desired position ①.

To lower the head restraint:

1. Push and hold the release button ② on the head restraint support.
2. Lower the head restraint to the desired position ③.

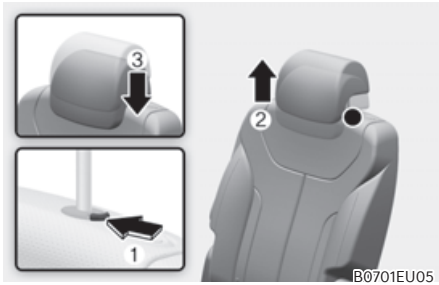

B0701EU05

### Removal/Reinstallation

To remove the head restraint:

1. Raise the head restraint as far as it can go.
2. Press the head restraint release button ① while pulling the head restraint up ②.

To reinstall the head restraint:

1. Put the head restraint poles into the holes ③ while pressing the release button ①.
2. Adjust the head restraint to the appropriate height.

### Folding 3<sup>rd</sup> row headrest (except for center)

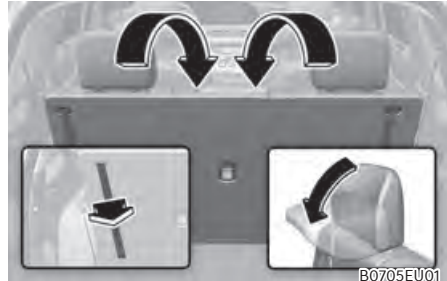

B0705EU01

The headrest will fold down automatically when folding the seatback.

To fold the headrest manually:

- Pull the strap.

To unfold the headrest manually:

- Raise the headrest manually.

Always be sure the headrest has locked into position after you return the seatback.

### **i** Information

The height of the 3<sup>rd</sup> row headrests cannot be adjusted.



### Wing-out headrest adjustment (if equipped)

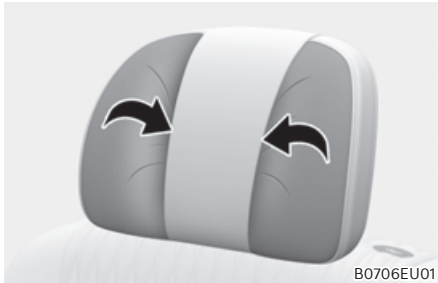

While driving, the wing-out headrest supports the passenger's head from shaking. Hold both ends of the wing-out headrest with your hands, and pull out or push in to adjust its position.

#### **i** Information

When the wing-out headrest is not in use, hold both ends of the headrest and pull out to return it to its original position.

### Seat Warmers

Seat warmers are provided to warm the seats during cold weather.

During mild weather or under conditions where the operation of the seat warmer is not needed, keep the seat warmers OFF.

#### **⚠** WARNING

The seat warmers can cause a **SERIOUS BURN**, even at low temperatures and especially if used for long periods of time.

Passengers must be able to feel if the seat is becoming too warm so they can turn it off, if needed.

People who cannot detect temperature change or pain to the skin should use extreme caution, especially the following types of passengers:

- Infants, children, elderly or disabled persons, or hospital outpatients.
- People with sensitive skin or who burn easily.
- Fatigued individuals.
- Intoxicated individuals.
- People taking medication that can cause drowsiness or sleepiness.

**WARNING**

**NEVER** place anything on the seat that insulates against heat when the seat warmer is in operation, such as a blanket or seat cushion. This may cause the seat warmer to overheat, causing a burn or damage to the seat.

**NOTICE**

To prevent damage to the seat warmers and seats:

- Never use a solvent such as paint thinner, benzene, alcohol or gasoline to clean the seats.
- Do not place heavy or sharp objects on seats equipped with seat warmers.
- Do not change the seat cover. It may damage the seat warmer.

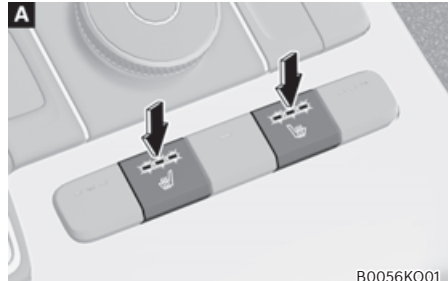

Ⓐ: Front seat, Ⓑ: 2<sup>nd</sup> row seat,  
Ⓒ: 3<sup>rd</sup> row seat (if equipped)

While the engine is running, push either of the switches to warm the driver's seat or front passenger's seat.

The seat warmer will operate and the warming light will illuminate to indicate that the function is in use.

- Manual temperature control Each time you push the switch, the temperature setting of the seat is changed as follow :

- Front seat



- Rear seat

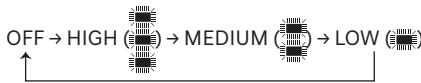

- Automatic temperature control The seat warmer starts to automatically control the seat temperature in order to prevent low-temperature burns after being manually turned ON.

- Front seat



- 2<sup>nd</sup> row seat

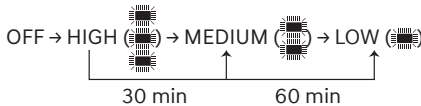

- Settings for Auto-Adjustment (for driver's seat, if equipped)

The seat warmer automatically controls the seat temperature depending on the ambient temperature when the vehicle is running. To use this function, it must be enabled from the Settings menu in the infotainment system screen. Select :

- Setup → Vehicle → Seat → Warmer/  
Ventilation Features → Driver Seat  
Warmer/Ventilation

- When pressing the switch for more than 1.5 seconds with the seat warmer operating, the seat warmer will turn off.
- The seat warmer defaults to the OFF position whenever the ignition switch is placed to the ON position.

### **i** Information

**The infotainment system may change after software updates. For more information, refer to the user's manual provided in the infotainment system and the quick reference guide.**

### Air Ventilation Seats (if equipped)

The air ventilation seats are provided to cool the front seats by blowing air through small vent holes on the surface of the seat cushions and seatbacks.

When the operation of the air ventilation seat is not needed, keep the air ventilation seats OFF.

**NOTICE**

To prevent damage to the air ventilation seats:

- Never use a solvent such as paint thinner, benzene, alcohol or gasoline to clean the seats.
- Avoid spilling liquids on the surface of the front seats and seatbacks; this may cause the air vent holes to block and not work properly.
- Do not place materials such as plastic bags or newspapers under the seats. They may block the air intake causing malfunction of the air vent.
- Do not change the seat covers. It may damage the air ventilation seat.
- If the air vents do not operate, restart the vehicle. If there is no change, have your vehicle inspected by an authorized HYUNDAI dealer.

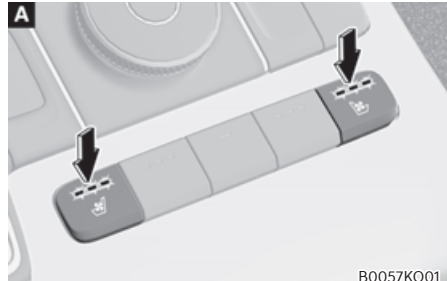

B0057K001



B0057K002

Ⓐ: Front seat, Ⓑ: Rear seat

- Each time you push the switch, the temperature setting of the seat changed as shown below:
- Front seat



- 2<sup>nd</sup> row seat



- If the air ventilation seat is positioned at HIGH, the airflow speed will increase according to vehicle speed.
- Use the air ventilation seat with the air conditioning on for more effective ventilation.
- It may take 3~5 minutes after switch operation to feel the temperature change.
- When pressing the switch for more than 1.5 seconds with the air ventilation seat operating, the operation will turn OFF.

- The air ventilation seats default to the OFF position whenever the ignition switch is placed to the ON position.
- Climate Settings for Auto-Adjustment (for driver's seat)

The air ventilation seat automatically controls the seat temperature depending on the ambient temperature when the vehicle is running. To use this function, it must be enabled from the Settings menu in the infotainment system screen. Select :

- Setup → Vehicle → Seat → Warmer/Ventilation Features → Driver Seat Warmer/Ventilation

### Information

The infotainment system may change after software updates. For more information, refer to the user's manual provided in the infotainment system and the quick reference guide.

### Information

- If the outside temperature is under approximately 33°F (2°C), the air ventilation seat may not operate.
- Use the air ventilation seat when the climate control system is on. Using the air ventilation seat for prolonged periods of time with the climate control system off could cause the climate control seat performance to be reduced.

### **NOTICE**

To prevent damage to the air ventilation seat:

- Use the air ventilation seat **ONLY** when the climate control system is on. Using the air ventilation seat for prolonged periods of time with the climate control system off could cause the air ventilation seat to malfunction.
- Never use a solvent such as paint thinner, benzene, alcohol or gasoline to clean the seats.
- Avoid spilling liquids on the surface of the front seats and seatbacks; this may cause the air vent holes to become blocked and not work properly.
- Do not place materials such as plastic bags or newspapers under the seats. They may block the air intake causing the air vents to not work properly.
- Do not change the seat covers. It may damage the air ventilation seat.
- If the air vents do not operate, restart the vehicle. If there is no change, have the vehicle inspected by an authorized HYUNDAI dealer.

## SEAT BELTS

This section describes how to use the seat belts properly. It also describes some of the things not to do when using seat belts.

### Seat Belt Safety Precautions

Always fasten your seat belt and make sure all passengers have fastened their seat belts before starting any trip. Air bags are designed to supplement the seat belt as an additional safety device, not a replacement. Most states require all occupants of a vehicle to wear seat belts.



#### WARNING

Seat belts must be used by **ALL** passengers whenever the vehicle is moving. Take the following precautions when adjusting and wearing seat belts:

- **ALWAYS** properly restrain children under age 13 in the rear seats.
- **NEVER** allow children to ride in the front passenger seat. If a child age 13 or older must be seated in the front seat, move the seat as far back as possible and properly restrain them in the seat.
- **NEVER** allow an infant or child to be carried on an occupant's lap.
- **NEVER** ride with the seatback reclined when the vehicle is moving.
- Do not allow children to share a seat or seat belt.
- Do not wear the shoulder belt under your arm or behind your back.
- Always wear both the shoulder portion and lap portion of the lap/shoulder belt.

- **NEVER** wear a seat belt over fragile objects. If there is a sudden stop or impact, the seat belt can damage it.
- Do not use the seat belt if it is twisted. A twisted seat belt will not protect you properly in an accident.
- Do not use a seat belt if the webbing or hardware is damaged.
- Do not latch the seat belt into the buckles of other seats.
- **NEVER** unfasten the seat belt while driving. This may cause loss of vehicle control resulting in an accident.
- Make sure there is nothing in the buckle interfering with the seat belt latch mechanism. This may prevent the seat belt from fastening securely.
- No modifications or additions should be made by the user which will either prohibit the seat belt adjusting devices from operating to remove slack, or prohibit the seat belt assembly from being adjusted to remove slack.



#### WARNING

Damaged seat belts and seat belt assemblies will not operate properly. Always replace:

- Frayed, contaminated, or damaged webbing.
- Damaged hardware.
- The entire seat belt assembly after it has been worn in an accident, even if damage to webbing or assembly is not apparent.

## Seat Belt Warning Light

### Front seat belt warning



As a reminder to the driver, the seat belt warning light will illuminate for approximately 6 seconds each time the ignition switch is in the ON position regardless of belt fastening.

If you continue not to fasten the seat belt and you drive over 6 mph (9 km/h), the warning light will stay illuminated.

If you continue not to fasten the seat belt and you drive over 12 mph (20 km/h) the seat belt warning chime will sound for approximately 100 seconds and the corresponding warning light will blink.

If you unfasten the seat belt while driving under 12 mph (20 km/h), the seat belt warning light will illuminate until the seat belt is fastened.

If you unfasten the seat belt while driving over 12 mph (20 km/h), the seat belt warning chime will sound for approximately 100 seconds and the corresponding warning light will blink.

### Rear passenger's seat belt warning

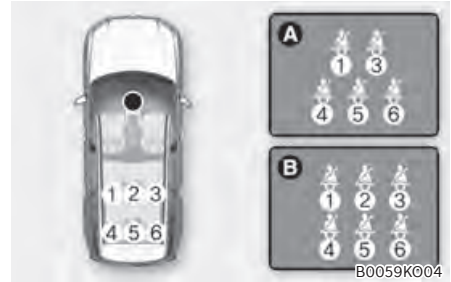

Ⓐ: 7-seater vehicle, Ⓑ: 8-seater vehicle

With the ignition switch ON, if the second row center seat passenger's seat belt is not fastened, the corresponding seat belt warning light will illuminate for 70 seconds. But, if the seatbelt is fastened after 6 seconds, the corresponding seat belt warning light will immediately turn off.

If the seat belt is fastened, and then unfastened while driving below 12 mph (20 km/h), the corresponding seat belt warning light will illuminate for 70 seconds.

If the seat belt is fastened, and then unfastened while driving above 12 mph (20 km/h), the corresponding seat belt warning light will blink and the warning chime will sound for approximately 35 seconds.



## WARNING

Riding in an improper position adversely affects the front passenger's seat belt warning system. It is important for the driver to instruct the passenger to properly be seated as instructed in this manual.



## Information

- Although the front passenger seat is not occupied, the seat belt warning light will blink or illuminate for 6 seconds.
- The front passenger's seat belt warning may operate when luggage is placed on the front passenger seat.

## Seat Belt Restraint System



## WARNING

Improperly positioned seat belts may increase the risk of serious injury in an accident. Take the following precautions when adjusting the seat belt:

- Position the lap portion of the seat belt as low as possible across your hips, not on your waist, so that it fits snugly.
- Position one arm under the shoulder belt and the other over the belt, as shown in the illustration.
- Always position the shoulder belt anchor into the locked position at the appropriate height.
- Never position the shoulder belt across your neck or face.



### **Front Seat Belt – Driver’s 3point system with emergency locking retractor**

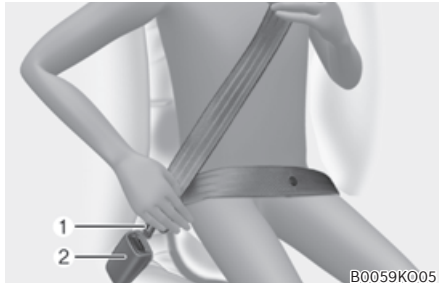

#### **To fasten your seat belt:**

Pull the seat belt out of the retractor and insert the metal tab (1) into the buckle (2). There will be an audible “click” when the tab locks into the buckle.

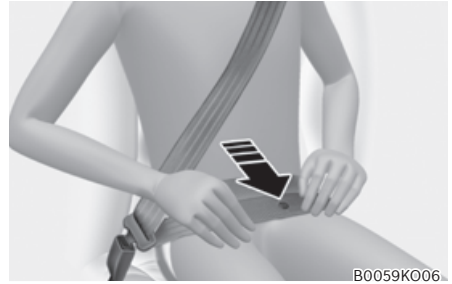

You should place the lap belt portion across your hips and the shoulder belt portion across your chest.

The seat belt automatically adjusts to the proper length after the lap belt portion is adjusted manually so that it fits snugly around your hips. If you lean forward in a slow, easy motion, the belt will extend and move with you.

If there is a sudden stop or impact, the belt will lock into position. It will also lock if you try to lean forward too quickly.

#### ***i* Information**

**If you are not able to smoothly pull enough of the seat belt out from the retractor, firmly pull the seat belt out and release it. After release, you will be able to pull the belt out smoothly.**

### Height adjustment

You can adjust the height of the shoulder belt anchor to one of the four different positions for maximum comfort and safety.

The shoulder portion should be adjusted so it lies across your chest and midway over your shoulder nearest the door, not over your neck.

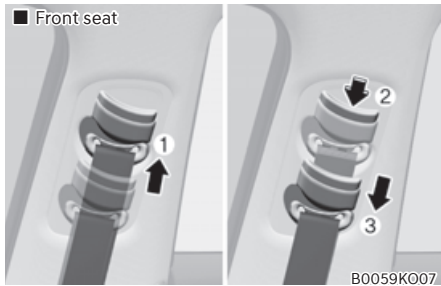

To adjust the height of the seat belt anchor, lower or raise the height adjuster into an appropriate position.

To raise the height adjuster, pull it up ①. To lower it, push it down ③ while pressing the height adjuster button ②.

Release the button to lock the anchor into position. Try sliding the height adjuster to make sure that it has locked into position.

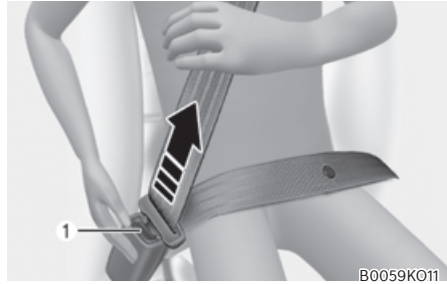

### To release your seat belt:

Press the release button ① in the locking buckle.

Once it is released, the belt should automatically draw back into the retractor. If this does not happen, check the belt to be sure it is not twisted, then try again.

### **Rear Seat Belt – Passenger’s 3point system with convertible locking retractor**

This type of seat belt combines the features of both an emergency locking retractor seat belt and an automatic locking retractor seat belt. Convertible retractor type seat belts are installed in the rear seat positions to help accommodate the installation of child restraint systems. Although a convertible retractor is also installed in the front passenger seat position, NEVER place any infant/child restraint system in the front seat of the vehicle.

#### **To fasten your seat belt:**

Pull the seat belt out of the retractor and insert the metal tab into the buckle. There will be an audible “click” when the tab locks into the buckle. When not securing a child restraint, the seat belt operates in the same way as the driver’s seat belt (Emergency Locking Retractor Type). It automatically adjusts to the proper length only after the lap belt portion of the seat belt is adjusted manually so that it fits snugly across your hips.

When the seat belt is fully extended from the retractor to allow the installation of a child restraint system, the seat belt operation changes to allow the belt to retract, but not to extend (Automatic Locking Retractor Type). Refer to the “Using a Child Restraint System” section in this chapter.

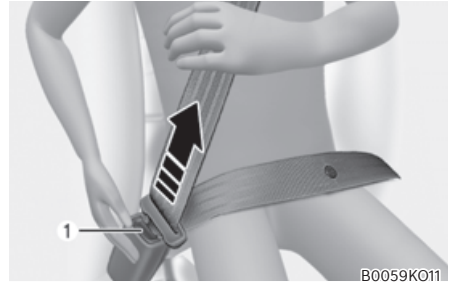

#### **To release your seat belt:**

Press the release button ① in the locking buckle.

When it is released, the belt should automatically draw back into the retractor. If this does not happen, check the belt to be sure it is not twisted, then try again.

#### **NOTICE**

**Although the seat belt retractor provides the same level of protection for seated passengers in either emergency or automatic locking modes, the emergency locking mode allows seated passengers to move freely in their seat while keeping some tension on the belt. During a collision or sudden stop, the retractor automatically locks the belt to help restrain your body.**

**To deactivate the automatic locking mode, unbuckle the seat belt and allow the belt to fully retract.**

### Second row center seatbelt (3-point rear center seat belt)

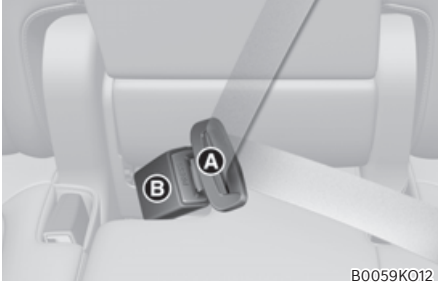

1. Take out the buckle (B), which is stored between the seat/seatback cushions.
2. Insert the metal plate (A) into the buckle (B), until it clicks.

You can make sure its secure fastening by pulling the seatbelt webbing. The buckle with 'CENTER' mark should be used for the 3-point seatbelt.

3. Restore the buckle between the seat/seatback cushion after unfastening the seatbelt.

### Rear center seatbelt (3<sup>rd</sup> row)



#### To fasten your seatbelt:

1. Extract the tongue plate (A) from the hole on the belt assembly cover.

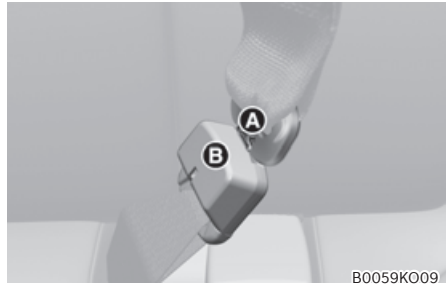

2. Insert the tongue plate (A) into the buckle (B) until an audible "click" is heard, indicating the latch is locked. Make sure the belt is not twisted.



3. Pull out the tongue plate © from the pocket. Pull the tongue plate © and insert it into the buckle ④ until an audible "click" is heard, indicating the latch is locked. Make sure the belt is not twisted.

When using the rear center seat belt, the buckle with the "CENTER" mark must be used.

### **i** Information

**If you are not able to pull out the safety belt from the retractor, firmly pull the belt out and release it. After release, you will be able to pull the belt out smoothly.**



### To release your seatbelt:

1. Press the release button on the buckle ④ and remove the tongue plate ©.

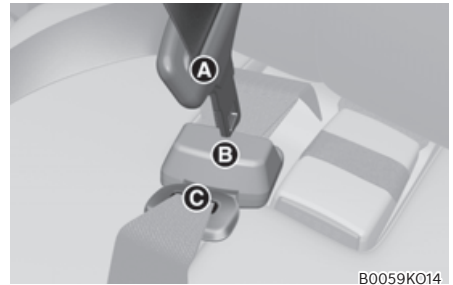

2. To retract the rear center seatbelt, insert the tongue © plate into the web release hole ②. Pull up on the seat belt web and allow the webbing to retract automatically. Insert the tongue plate ① into the hole on the belt assembly cover.

### Stowing the rear seat belt

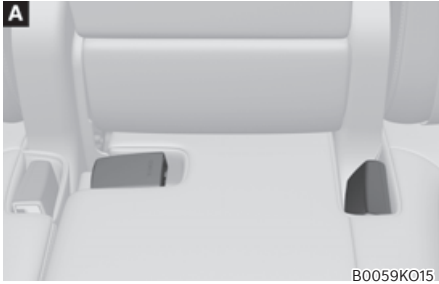

Ⓐ: 2<sup>nd</sup> row seat (8- seater), Ⓑ: 3<sup>rd</sup> seat

The rear seat belt buckles can be stowed in the pocket between the rear seatback and cushion when not in use.

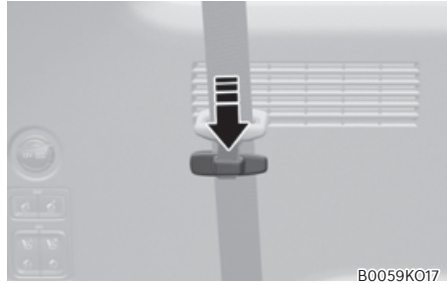

Routing the seat belt webbing through the rear seat belt guides will help keep the belts from being trapped behind or under the seats.

After inserting the seat belt, tighten the belt webbing by pulling it up.



#### CAUTION

**When using the seat belt, use it after taking it out of the guides.**

**If you pull the seat belt when it is stored in the guides, it may damage the guides and/or belt webbing.**

### **Pre-tensioner seat belt (Drive and front passenger)**

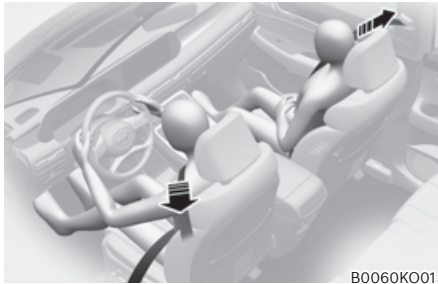

Your vehicle is equipped with driver's and front passenger's Pre-tensioner Seat Belts (Retractor Pre-tensioner). The purpose of the pre-tensioner is to make sure the seat belts fit tightly against the occupant's body in certain frontal or side collision(s). The pre-tensioner seat belts may be activated in crashes where the frontal or side collision(s) is severe enough, together with the air bags.

When the vehicle stops suddenly, or if the occupant tries to lean forward too quickly, the seat belt retractor will lock into position.

In certain frontal collisions, the pre-tensioner will activate and pull the seat belt into tighter contact against the occupant's body.

If the system senses excessive tension on the driver or passenger's seat belt when the pre-tensioner system activates, the load limiter inside the retractor pre-tensioner will release some of the pressure on the affected seat belt.

### **WARNING**

Pre-tensioner Seat Belts that malfunction may not protect you properly during an accident. Take the following precautions:

- Always wear your seat belt and sit properly in your seat.
- Do not use the seat belt if it is loose or twisted. A loose or twisted seat belt will not protect you properly in an accident.
- Do not place anything near the buckle. This may adversely affect the buckle and cause it to function improperly.
- Always replace your pre-tensioners after activation or an accident.
- NEVER inspect, service, repair or replace the pre-tensioners by yourself. This must be done by an authorized HYUNDAI dealer.
- Do not hit the seat belt assemblies.

### **WARNING**

Do not touch the pre-tensioner seat belt assemblies for several minutes after they have been activated. When the pre-tensioner seat belt mechanism deploys during a collision, the pre-tensioner can become hot and can burn you.

**CAUTION**

Body work on the front area of the vehicle may damage the pre-tensioner seat belt system. Therefore, have the system be serviced by an authorized HYUNDAI dealer.

The Pre-Tensioner Seat Belt System consists mainly of the following components. Their locations are shown in the illustration:

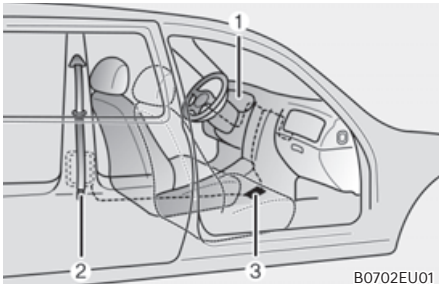

- ① SRS air bag warning light
- ② Retractor pre-tensioner
- ③ SRS control module

**NOTICE**

The sensor that activates the SRS control module is connected with the pre-tensioner seat belts. The SRS air bag warning light on the instrument cluster will illuminate for approximately 3~6 seconds after the ignition switch is in the ON position, and then it should turn off.

If the pre-tensioner is not working properly, the warning light will illuminate even if the SRS air bag is not malfunctioning. If the warning light does not illuminate, stays illuminated or illuminates when the vehicle is being driven, have the pre-tensioner seat belts and/or SRS control module inspected by an authorized HYUNDAI dealer as soon as possible.

**i Information**

- Both the driver's and front passenger's pre-tensioner seat belts may be activated in certain frontal or side collisions or rollovers.
- When the pre-tensioner seat belts are activated, a loud noise may be heard and fine dust, which may appear to be smoke, may be visible in the passenger compartment. These are normal operating conditions and are not hazardous.
- Although it is non-toxic, the fine dust may cause skin irritation and should not be inhaled for prolonged periods. Wash all exposed skin areas thoroughly after an accident in which the pre-tensioner seat belts were activated.
- The pre-tensioner seat belt system may get adversely affected by installing an audio system to the center console or welding/painting the frontal vehicle body.

In this case, consult an authorized HYUNDAI dealer. The air bag warning light illuminates, if there is a malfunction with the pre-tensioner seat belt system.

- In following situations, immediately have the air bag system and the pre-tensioner seat belt system checked by an authorized HYUNDAI dealer.
  - The air bag warning light does not illuminate at all after turning ON the engine
  - The air bag warning light remains ON over 3~6 seconds after turning ON the engine



## Additional Seat Belt Safety Precautions

### **Seat belt use during pregnancy**

The seat belt should always be used during pregnancy. The best way to protect your unborn child is to protect yourself by always wearing the seat belt.

Pregnant women should always wear a lap-shoulder seat belt. Place the shoulder belt across your chest, routed between your breasts and away from your neck. Place the lap belt below your belly so that it fits **SNUGLY** across your hips and pelvic bone, under the rounded part of the belly.



### **WARNING**

- **A pregnant woman or a patient is more vulnerable to any impacts on the abdomen during an abrupt stop or accident. If you are in an accident while pregnant, we recommend you consult your doctor.**
- **To reduce the risk of serious injury or death to an unborn child during an accident, pregnant women should NEVER place the lap portion of the seat belt above or over the area of the abdomen where the unborn child is located.**

## **Seat belt use and children**

### **Infant and small children**

All 50 states have Child Restraint System laws which require children to travel in approved Child Restraint System devices, including booster seats. The age at which seat belts can be used instead of Child Restraint System differs among states, so you should be aware of the specific requirements in your state, and where you are travelling. Infant and Child Restraint System must be properly placed and installed in a rear seat.

For more information refer to the “Child Restraint Systems” section in this chapter.



### **WARNING**

**ALWAYS properly restrain infants and small children in a Child Restraint System appropriate for the child’s height and weight.**

**To reduce the risk of serious injury or death to a child and other passengers, NEVER hold a child in your lap or arms when the vehicle is moving. The violent forces created during an accident will tear the child from your arms and throw the child against the interior of the vehicle.**

Small children are best protected from injury in an accident when properly restrained in the rear seat by a Child Restraint System that meets the requirements of the Federal Motor Vehicle Safety Standards. Before buying any Child Restraint System, make sure that it has a label certifying that it meets Federal Motor Vehicle Safety Standard FMVSS 213.

The Child Restraint System must be appropriate for your child’s height and weight. Check the label on the Child Restraint System for this information. Refer to “Child Restraint Systems” section in this chapter.

### Larger children

Children under age 13 and who are too large for a booster seat must always occupy the rear seat and use the available lap/shoulder belts. A seat belt should lie across the upper thighs and be snug across the shoulder and chest to restrain the child safely. Check belt fit periodically. Children are afforded the most safety in the event of an accident when they are restrained by a proper restraint system and/or seat belts in the rear seat. Always have the LATCH system inspected by your authorized HYUNDAI dealer after an accident. An accident can damage the LATCH system and may not properly secure the child restraint.

If a larger child over age 13 must be seated in the front seat, the child must be securely restrained by the available lap/shoulder belt and the seat should be placed in the rearmost position.

If the shoulder belt portion slightly touches the child's neck or face, try placing the child closer to the center of the vehicle. If the shoulder belt still touches their face or neck, they need to be returned to an appropriate booster seat in the rear seat.



### WARNING

- Always make sure larger children's seat belts are worn and properly adjusted.
- NEVER allow the shoulder belt to contact the child's neck or face.
- Do not allow more than one child to use a single seat belt.

### Transporting an injured person

A seat belt should be used when an injured person is being transported. Consult a physician for specific recommendations.

### One person per belt

Two people (including children) should never attempt to use a single seat belt. This could increase the severity of injuries in case of an accident.

### Do not lie down

Sitting in a reclined position when the vehicle is in motion can be dangerous. Even when buckled up, the protections of your restraint system (seat belts and/or air bags) is greatly reduced by reclining your seatback.

To reduce the chance of injuries in the event of an accident and to achieve the maximum effectiveness of the restraint system, all passengers should be sitting up and the front and rear seats should be in an upright position when the car is moving.

A seat belt cannot provide proper protection if the person is lying down in the rear seat or if the front or rear seats are in a reclined position.



### WARNING

- NEVER ride with a reclined seatback when the vehicle is moving.
- Riding with a reclined seatback increases your chance of serious or fatal injuries in the event of a collision or sudden stop.
- Driver and passengers should always sit well back in their seats, properly belted, and with the seatbacks upright.

## Care of Seat Belts

Seat belt systems should never be disassembled or modified. In addition, care should be taken to assure that seat belts and belt hardware are not damaged by seat hinges, doors or other abuse.

### ***Periodic inspection***

All seat belts should be inspected periodically for wear or damage of any kind. Any damaged parts should be replaced as soon as possible by an authorized HYUNDAI dealer.

### ***Keep belts clean and dry***

Seat belts should be kept clean and dry. If belts become dirty, they can be cleaned by using a mild soap solution and warm water. Bleach, dye, strong detergents or abrasives should not be used because they may damage and weaken the fabric.

### ***When to replace seat belts***

The entire seat belt assembly or assemblies should be replaced if the vehicle has been involved in an accident. This should be done even if no damage is visible. Additional questions concerning seat belt operation should be directed to an authorized HYUNDAI dealer.

## CHILD RESTRAINT SYSTEM (CRS)

### Children Always in the Rear



#### WARNING

**Always properly restrain children in the vehicle. Children of all ages are safer when restrained in the rear seat. A child riding in the front passenger seat can be forcefully struck by an inflating air bag resulting in SERIOUS INJURY or DEATH.**

Children under age 13 should always ride in the rear seats and must always be properly restrained to minimize the risk of injury in an accident, sudden stop or sudden maneuver.

According to accident statistics, children are safer when properly restrained in the rear seats than in the front seat. **Even with air bags, children can be seriously injured or killed.** Children too large for a Child Restraint System must use the seat belts provided.

All 50 states have child restraint laws which require children to travel in approved Child Restraint Systems.

The laws governing the age or height/weight restrictions at which seat belts can be used instead of Child Restraint System differs among states, so you should be aware of the specific requirements in your state, and where you are travelling.

Child Restraint Systems must be properly placed and installed in the rear seat. You must use a commercially available Child Restraint System that meets the requirements of the Federal Motor Vehicle Safety Standards (FMVSS 213).

Child Restraint Systems are generally designed to be secured in a vehicle seat by lap belt portion of a lap/shoulder belt, or by a LATCH system in the rear seats of the vehicle.

### **Child Restraint System (CRS)**

Infants and younger children must be restrained in an appropriate rearward-facing or forward-facing CRS that has first been properly secured to the seat of the vehicle. Read and comply with the instructions for installation and use provided by the manufacturer of the Child Restraint System.



#### WARNING

**An improperly secured child restraint can increase the risk of SERIOUS INJURY or DEATH in an accident. Always take the following precautions when using a Child Restraint System:**

- **NEVER** install a child or infant restraint in the front passenger's seat.
- **Always properly secure the child restraint to a rear seat of the vehicle.**
- **Always follow the child restraint system manufacturer's instructions for installation and use.**
- **Always properly restrain your child in the child restraint.**
- **If the vehicle head restraint prevents proper installation of a child seat (as described in the child restraint system manual), the head restraint of the respective seating position shall be readjusted or entirely removed.**
- **Do not use an infant carrier or a child safety seat that "hooks" over a seatback, it may not provide adequate protection in an accident.**
- **After an accident, have a HYUNDAI dealer check the child restraint system, seat belts, tether anchors and lower anchors.**

## Selecting a Child Restraint System (CRS)

When selecting a Child Restraint System for your child, always:

- Make sure the Child Restraint System has a label certifying that it meets applicable Federal Motor Vehicle Safety Standards (FMVSS 213).
- Select a Child Restraint System based on your child's height and weight. The required label or the instructions for use typically provide this information.
- Select a Child Restraint System that fits the vehicle seating position where it will be used.
- Read and comply with the warnings and instructions for installation and use provided with the Child Restraint System.

### Child Restraint System types

There are three main types of Child Restraint Systems: rearward-facing, forward-facing and booster Child Restraint Systems.

They are classified according to the child's age, height and weight.



B0065K001

### Rearward-facing Child Restraint System

A rearward-facing Child Restraint System provides restraint with the seating surface against the back of the child.

The harness system holds the child in place, and in an accident, acts to keep the child positioned in the Child Restraint Systems and reduce the stress to the fragile neck and spinal cord.

All children under the age of one year must always ride in a rearward-facing Child Restraint System. Convertible and 3-in-1 Child Restraint Systems typically have higher height and weight limits for the rearward-facing position, allowing you to keep your child rearward-facing for a longer period of time.

Continue using Child Restraint Systems in the rearward-facing position as long as children fit within the height and weight limits allowed by the Child Restraint System's manufacturer. It's the best way to keep them safe. Once your child has outgrown the rearward-facing Child Restraint System, your child is ready for a forward-facing Child Restraint System with a harness.



### WARNING

**NEVER install a child or infant restraint in the front passenger's seat.**

**Placing a rearward-facing child restraint in the front seat can result in SERIOUS INJURY or DEATH if the child restraint is struck by an inflating air bag.**



### Forward-facing Child Restraint System

A forward-facing Child Restraint System provides restraint for the child's body with a harness. Keep children in a forward-facing Child Restraint System with a harness until they reach the top height or weight limit allowed by your Child Restraint System's manufacturer.

Once your child outgrows the forward-facing Child Restraint System, your child is ready for a booster seat.

### Booster seats

A booster seat is a Child Restraint System designed to improve the fit of the vehicle's seat belt system. A booster seat positions the seat belt so that it fits properly over the lap of your child. Keep your children in booster seats until they are big enough to fit in a seat belt properly.

For a seat belt to fit properly, the lap belt must lie comfortable across the upper thighs, not the stomach. The shoulder belt should lie comfortable across the shoulder and chest and not across the neck or face. Children under age 13 must always be properly restrained to minimize the risk of injury in an accident, sudden stop or sudden maneuver.

## Installing a Child Restraint System (CRS)

### WARNING

Before installing your Child Restraint System always:

- Read and follow the instructions provided by the manufacturer of the Child Restraint System.
- Read and follow the instructions regarding child restraint systems in this manual.

**Failure to follow all warnings and instructions could increase the risk of the SERIOUS INJURY or DEATH if an accident occurs.**

### WARNING

**If the vehicle head restraint prevents proper installation of a Child Restraint System, the head restraint of the respective seating position shall be readjusted or entirely removed.**

After selecting a proper Child Restraint System for your child and checking that the Child Restraint System fits properly on the seating position, there are three general steps for a proper installation:

- **Properly secure the Child Restraint System to the vehicle.** All Child Restraint Systems must be secured to the vehicle with the lap part of a lap/shoulder belt or with the LATCH system.

- **Make sure the Child Restraint System is firmly secured.** After installing a Child Restraint System to the vehicle, push and pull the seat forward and from side-to-side to verify that it is securely attached to the seat. A Child Restraint System secured with a seat belt should be installed as firmly as possible. However, some side-to-side movement can be expected.

When installing a Child Restraint System, adjust the vehicle seat and seatback (up and down, forward and rearward) so that your child fits in the Child Restraint System in a comfortable manner.

- **Secure the child in the Child Restraint System.** Make sure the child is properly strapped in the Child Restraint System according to the Child Restraint System manufacturer's instructions.



### **CAUTION**

**A Child Restraint System in a closed vehicle can become very hot. To prevent burns, check the seating surface and buckles before placing your child in the Child Restraint System.**

### ***Lower Anchors and Tether for Children (LATCH System)***

The LATCH system holds a Child Restraint System during driving and in an accident. This system is designed to make installation of the Child Restraint System easier and reduce the possibility of improperly installing your Child Restraint System. The LATCH system uses anchors in the vehicle and attachments on the Child Restraint System. The LATCH system eliminates the need to use seat belts to secure the Child Restraint System to the rear seats.

Lower anchors are metal bars built into the vehicle. There are two lower anchors for each LATCH seating position that will accommodate a Child Restraint System with lower attachments.

To use the LATCH system in your vehicle, you must have a Child Restraint System with LATCH attachments.

The Child Restraint System manufacturer will provide you with instructions on how to use the Child Restraint System with its attachments for the LATCH lower anchors.

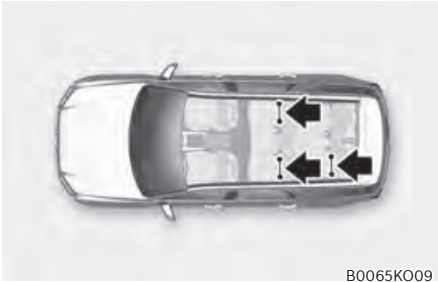

LATCH anchors have been provided in the left and right outboard rear seating positions. Their locations are shown in the illustration.

There are no LATCH anchors provided for the center rear seating position.

 **WARNING**

**Do not attempt to install a Child Restraint System using LATCH anchors in the rear center seating position. There are no LATCH anchors provided for this seat. Using the outboard seat anchors can damage the anchors which may break or fail in a collision resulting in serious injury or death.**

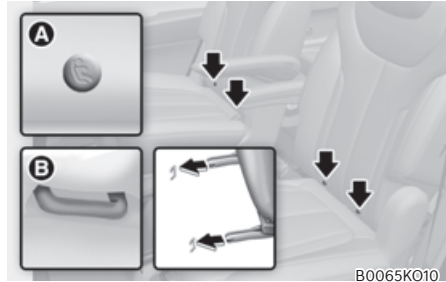

- Ⓐ: Lower Anchor Position Indicator
- Ⓑ: Lower Anchor

The lower anchor position indicator symbols are located on the left and right rear seat backs to identify the position of the lower anchors in your vehicle (see arrows in illustration).

The LATCH anchors are located between the seatback and the seat cushion of the rear seat left and right outboard seating positions.

 **WARNING**

**Before installing the Child Restraint System, make sure that there are no objects (e.g. toy, pen, wire) around the lower anchor area. Those objects may damage either the seat belt system or the Child Restraint System during the installment procedure. If necessary, have the vehicle inspected by an authorized HYUNDAI dealer.**



### Securing a Child Restraint System with the “LATCH Anchors System”

To install a LATCH-compatible Child Restraint System in either of the rear outboard seating positions:

1. Move the seat belt buckle away from the lower anchors.
2. Move any other objects away from the anchors that could prevent a secure connection between the Child Restraint System and the lower anchors.
3. Place the Child Restraint System on the vehicle seat, then attach the seat to the lower anchors according to the instructions provided by the Child Restraint System manufacturer.
4. Follow the instructions of the Child Restraint System’s manufacturer for proper installation and connection of the lower attachments on the Child Restraint System to the lower anchors.



### WARNING

Take the following precautions when using the LATCH system:

- Read and follow all installation instructions provided with your Child Restraint System.
- To prevent the child from reaching and taking hold of unretracted seat belts, buckle all unused rear seat belts and retract the seat belt webbing behind the child. Children can be strangled if a shoulder belt becomes wrapped around their neck and the seat belt tightens.
- NEVER attach more than one Child Restraint System to a single anchor. This could cause the anchor or attachment to come loose or break.
- Always have the LATCH system inspected by your authorized HYUNDAI dealer after an accident. An accident can damage the LATCH system and may not properly secure the child restraint.

### NOTICE

The recommended weight for the LATCH system is under 65 lb. (30 kg).

How to determine an appropriate child restraint weight: Child weight + Child restraint weight < 65 lb. (30kg)

### Securing a Child Restraint System seat with “Tether Anchor” system



Ⓐ: 2<sup>nd</sup> row passenger seat

Ⓑ: 3<sup>rd</sup> row passenger seat

First secure the child restraint with the LATCH lower anchors or the seat belt. If the child restraint manufacturer recommends that the top tether strap be attached, attach and tighten the top tether strap to the top tether strap anchor.

Child restraint hook holders are located on the rear of the seatbacks.



To install the tether anchor:

1. Route the Child Restraint System top-tether strap over the seatback. Route the tether strap under the head restraint and between the head restraint posts, or route the tether strap over the top of the vehicle seatback. Make sure the strap is not twisted.
2. Connect the tether strap hook to the tether anchor, then tighten the top-tether strap according to the instructions of your Child Restraint System's manufacturer to firmly attach the Child Restraint System to the seat.
3. Check that the Child Restraint System is securely attached to the seat by pushing and pulling the seat forward-and-back and side-to-side.



### WARNING

Take the following precautions when installing the tether strap:

- Read and follow all installation instructions provided with your Child Restraint System.
- **NEVER** attach more than one Child Restraint System to a single tether anchor. This could cause the anchor or attachment to come loose or break.
- Do not attach the tether strap to anything other than the correct top-tether anchor. It may not work properly if attached to something else.
- Child Restraint System anchors are designed to withstand only those loads imposed by correctly fitted Child Restraint System.

**Under no circumstances are the anchors to be used for adult seat belts or harnesses or for attaching other items or equipment to the vehicle.**

### **Securing a Child Restraint System with a lap/shoulder belt**

When not using the LATCH system, all Child Restraint Systems must be secured to a rear seat with the lap part of a lap/shoulder belt.



#### **WARNING**

**ALWAYS** place a rearward-facing Child Restraint System in the rear seat of the vehicle.

**Placing a rearward-facing child restraint in the front seat can result in serious injury or death if the Child Restraint System is struck by an inflating air bag.**



#### **Automatic locking mode**

Since all passenger seat belts move freely under normal conditions and only lock under extreme or emergency conditions (emergency locking mode), you must manually pull the seat belt all the way out to shift the retractor to the "Automatic Locking" mode to secure a Child Restraint System.

The "Automatic Locking" mode will help prevent the normal movement of the child in the vehicle from causing the seat belt to loosen and compromise the Child Restraint System. To secure a Child Restraint System, use the following procedure.

To install a Child Restraint System on the rear seats, do the following:

1. Place the Child Restraint System on a rear seat and route the lap/shoulder belt around or through the Child Restraint System, following the Child Restraint System manufacturer's instructions. Make sure the seat belt webbing is not twisted.



#### **Information**

**When using the rear center seat belt, you should also refer to the "Rear Seat Belt – Passenger's 3-point system" section in this chapter.**



2. Fasten the lap/shoulder belt latch into the buckle. Listen for the distinct "click" sound.

**i** Information

Position the release button so that it is easy to access in case of an emergency.

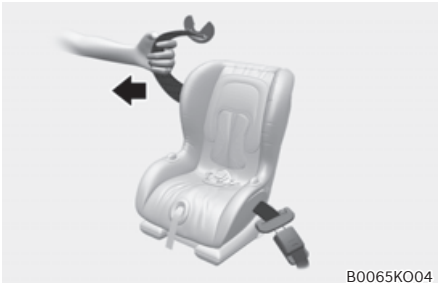

3. Pull the shoulder portion of the seat belt all the way out. When the shoulder portion of the seat belt is fully extended, it will shift the retractor to the "Automatic Locking" (child restraint) mode.

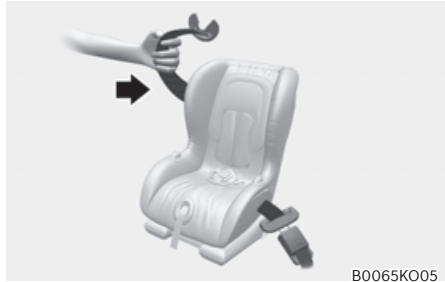

4. Slowly allow the shoulder portion of the seat belt to retract and listen for an audible "clicking" or "ratcheting" sound. This indicates that the retractor is in the "Automatic Locking" mode. If no distinct sound is heard, repeat steps 3 and 4.
5. Remove as much slack from the belt as possible by pushing down on the Child Restraint System while feeding the shoulder belt back into the retractor.

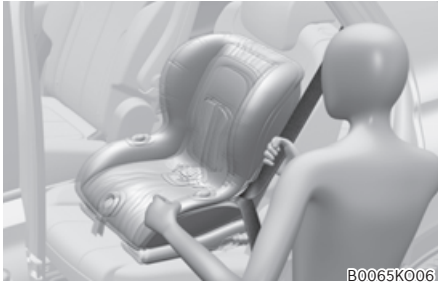

6. Push and pull on the Child Restraint System to confirm that the seat belt is holding it firmly in place. If it is not, release the seat belt and repeat steps 2 through 6.
7. Double check that the retractor is in the "Automatic Locking" mode by attempting to pull more of the seat belt out of the retractor. If you cannot, the retractor is in the "Automatic Locking" mode.

If your Child Restraint System manufacturer instructs or recommends you to use a tether anchor with the lap/shoulder belt, refer to the previous pages for more information.

### Information

When the seat belt is allowed to retract to its fully stowed position, the retractor will automatically switch from the "Automatic Locking" mode to the emergency lock mode for normal adult usage.

### WARNING

**If the retractor is not in the "Automatic Locking" mode, the child restraint can move when your vehicle turns or stops suddenly. A child can be seriously injured or killed if the child restraint is not properly anchored in the car, including manually pulling the seat belt all the way out to shift the retractor to the "Automatic Locking" mode.**

To remove the Child Restraint System, press the release button on the buckle and then pull the lap/shoulder belt out of the Child Restraint System and allow the seat belt to retract fully.

## AIR BAG - SUPPLEMENTAL RESTRAINT SYSTEM

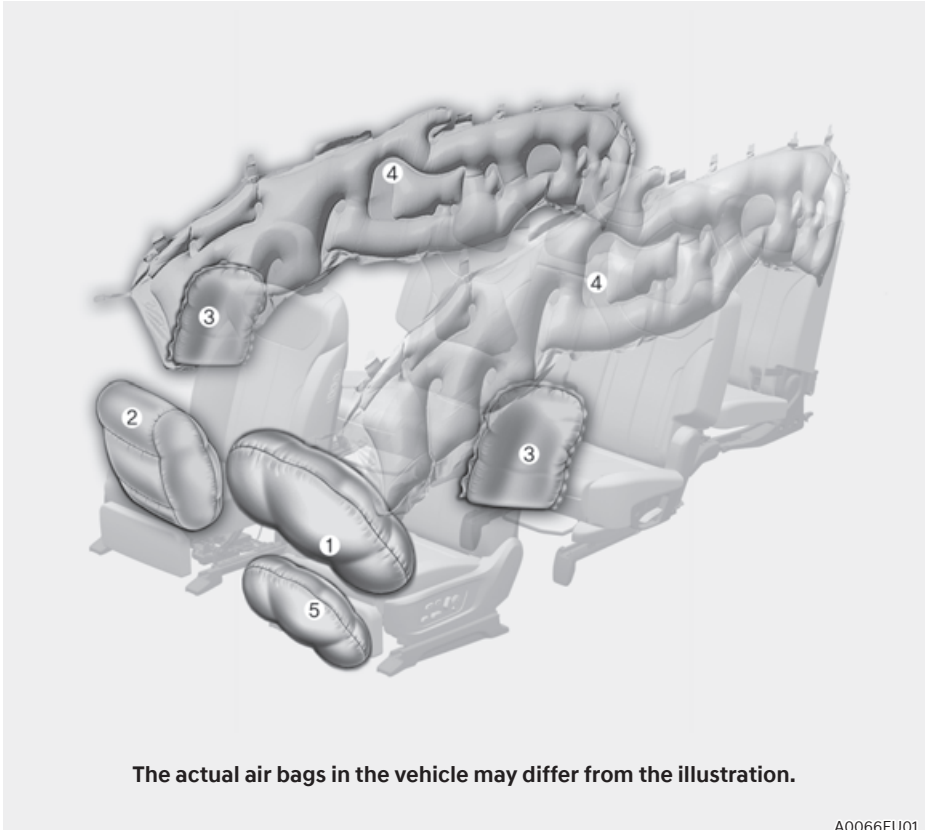

- 1. Driver's front air bag
- 2. Passenger's front air bag
- 3. Side air bag
- 4. Curtain air bag
- 5. Driver's knee air bag

The vehicles are equipped with an Advanced Supplemental Air Bag System for the driver's seat and front passenger's seats.

The front air bags are designed to supplement the three-point seat belts. For these air bags to provide protection, the seat belts must be worn at all times when driving.

You can be severely injured or killed in an accident if you are not wearing a seat belt. Air bags are designed to supplement seat belts, but do not replace them. Also, air bags are not designed to deploy in every collision. In some accidents, the seat belts are the only restraint protecting you.



## **WARNING**

### **AIR BAG SAFETY PRECAUTIONS**

**ALWAYS** use seat belts and Child Restraint Systems - every trip, every time, everyone! Even with air bags, you can be seriously injured or killed in a collision if you are improperly belted or not wearing your seat belt when the air bag inflates.

**NEVER** place a child in any Child Restraint System or booster seat in the front passenger seat, unless the air bag is deactivated.

An inflating air bag could forcefully strike the infant or child causing serious or fatal injuries.

**ABC - Always Buckle Children** under age 13 in the back seat. It is the safest place for children of any age to ride. If a child age 13 or older must be seated in the front seat, he or she must be properly belted and the seat should be moved as far back as possible.

All occupants should sit upright with the seatback in an upright position, centered on the seat cushion with their seat belt on, legs comfortably extended and their feet on the floor until the vehicle is parked and the vehicle is turned off. If an occupant is out of position during an accident, the rapidly deploying air bag may forcefully contact the occupant causing serious or fatal injuries.

You and your passengers should never sit or lean unnecessarily close to the air bags or lean against the door or center console.

Move your seat as far back as possible from front air bags, while still maintaining control of the vehicle. The U.S. National Highway Traffic Safety Administration (NHTSA) recommends that drivers allow at least 10 inches (25 cm) between the center of the steering wheel and the chest.

## Where Are the Air Bags?

### Driver's and passenger's front air bags

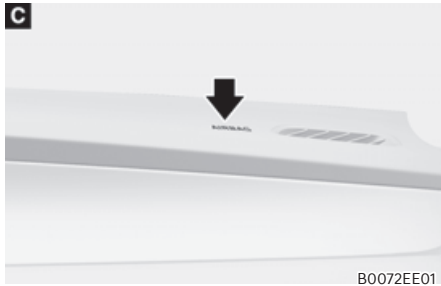
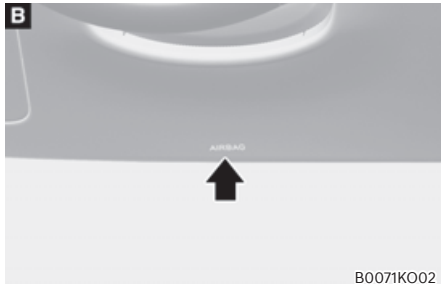

- Ⓐ: Driver's front air bag, Ⓑ: Driver's knee air bag,  
Ⓒ: Passenger's front air bag

Your vehicle is equipped with an Advanced Supplemental Restraint System (SRS) and lap/shoulder belts at both the driver and passenger seating positions.

The SRS consists of air bags which are located in the center of the steering wheel, in the driver's side lower crash pad below the steering wheel, and the passenger's side front panel pad above the glove box.

The air bags are labeled with the letters "AIR BAG" embossed on the pad covers.

The purpose of the SRS is to provide the vehicle's driver and front passengers with additional protection than that offered by the seat belt system alone in case of a frontal impact of sufficient severity.

The SRS uses sensors to gather information about the driver's and front passenger's seat belt usage and impact severity.

The seat belt buckle sensors determine if the driver and front passenger's seat belts are fastened. These sensors provide the ability to control the SRS deployment based on whether or not the seat belts are fastened, and how severe the impact is.

The advanced SRS offers the ability to control the air bag inflation within two levels. A first stage level is provided for moderate-severity impacts. A second stage level is provided for more severe impacts.

According to the impact severity, and seat belt usage, the SRS Control Module (SRSCM) controls the air bag inflation. Failure to properly wear seat belts can increase the risk or severity of injury in an accident.





## WARNING

To reduce the risk of serious injury or death from inflating front air bags, take the following precautions:

- Seat belts must be worn at all times to help keep occupants positioned properly.
- Move your seat as far back as possible from front air bags, while still maintaining control of the vehicle.
- Never lean against the door or center console.
- Do not allow the front passenger to place their feet or legs on the dashboard.
- No objects (such as crash pad cover, mobile phone holder, cup holder, perfume or stickers) should be placed over or near the air bag modules on the steering wheel, instrument panel, windshield glass, and the front passenger's panel above the glove box. Such objects could cause harm if the vehicle is in a crash severe enough to cause the air bags to deploy.
- Do not attach any objects on the front windshield and inside mirror.

## Side air bags



B0074EU01



B0070EU01

Your vehicle is equipped with a side air bag in each front seat. The purpose of the air bag is to provide the vehicle's additional protection than that offered by the seat belt alone.

The side air bags are designed to deploy during certain side impact collisions, depending on the crash severity.

The side and/or curtain air bags and pretensioners on both sides of the vehicle may deploy if a rollover or possible rollover is detected.

The side air bags are not designed to deploy in all side impact or rollover situations.



### **WARNING**

To reduce the risk of serious injury or death from an inflating side air bag take the following precautions:

- **Seat belts must be worn at all times to help keep occupants positioned properly.**
  - **Do not allow passengers to lean their heads or bodies onto doors, put their arms on the doors, stretch their arms out of the window, or place objects between the doors and seats.**
  - **Hold the steering wheel at the 9 o'clock and 3 o'clock positions, to minimize the risk of injuries to your hands and arms.**
  - **Do not use any accessory seat covers. This could reduce or prevent the effectiveness of the system.**
  - **Do not hang other objects except clothes. In an accident it may cause vehicle damage or personal injury especially when air bag is inflated.**
- **Do not place any objects over the air bag or between the air bag and yourself. Also, do not attach any objects around the area the air bag inflates such as the door, side door glass, front and rear pillar.**
  - **Do not place any objects between the door and the seat. They may become dangerous projectiles if the side air bag inflates.**
  - **Do not install any accessories on the side or near the side air bags.**
  - **Do not cause impact to the doors when the ignition switch is in the ON or START position as this may cause the side air bags to inflate.**
  - **If the seat or seat cover is damaged, have the vehicle checked and repaired by an authorized HYUNDAI dealer.**

## Curtain air bags



B0075KO01



B0076EU01

Curtain air bags are located along both sides of the roof rails above the front and rear doors.

They are designed to help protect the heads of the front seat occupants and the rear outboard seat occupants in certain side impact collisions.

The curtain air bags are designed to deploy during certain side impact collisions, depending on the crash severity.

The side and/or curtain air bags and pretensioners on both sides of the vehicle may deploy if a rollover or possible rollover is detected.

The curtain air bags are not designed to deploy in all side impact or rollover situations.

### **WARNING**

To reduce the risk of serious injury or death from an inflating curtain air bag, take the following precautions:

- All seat occupants must wear seat belts at all times to help keep occupants positioned properly.
- Properly secure Child Restraint System as far away from the door as possible.
- Do not place any objects over the air bag. Also, do not attach any objects around the area the air bag inflates such as the door, side door glass, front and rear pillar, roof side rail.
- Do not hang other objects except clothes, especially hard or breakable objects.  
In an accident, it may cause vehicle damage or personal injury.
- Do not allow passengers to lean their heads or bodies onto doors, put their arms on the doors, stretch their arms out of the window, or place objects between the doors and seats.
- Do not open or repair the side curtain air bags.

## How Does the Air Bags System Operate?

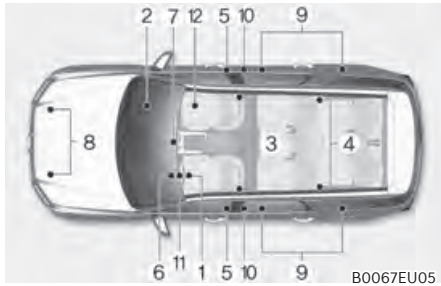

The SRS consists of the following components:

- ① Driver's front air bag module
- ② Passenger's front air bag module
- ③ Side air bag modules
- ④ Curtain air bag modules
- ⑤ Front retractor pre-tensioner
- ⑥ Air bag warning light
- ⑦ SRS control module (SRSCM) / Rollover sensor
- ⑧ Front impact sensors
- ⑨ Side impact sensors (acceleration)
- ⑩ Side impact sensors (pressure)
- ⑪ Driver's knee air bag module
- ⑫ Occupant Classification System (OCS)

### **i** Information

**Front passenger's air bag OFF lamp is located on the overhead console.**

The SRSCM (Supplemental Restraint System Control Module) continually monitors all SRS components while the ignition switch is ON to determine if a crash impact is severe enough to require air bag deployment or pre-tensioner seat belt deployment.



### **SRS warning light**

The SRS (Supplemental Restraint System) air bag warning light on the instrument panel displays the air bag symbol depicted in the illustration. The system checks the air bag electrical system for malfunctions. The light indicates that there is a potential problem with your air bag system, which could include your side and curtain air bags used for rollover protection.

**WARNING**

**If your SRS malfunctions, the air bag may not inflate properly during an accident increasing the risk of serious injury or death.**

**If any of the following conditions occur, your SRS is malfunctioning:**

- **The light does not turn on for approximately three to six seconds when the ignition switch is in the ON position.**
- **The light stays on after illuminating for approximately three to six seconds.**
- **The light comes on while the vehicle is in motion.**
- **The light blinks when the engine is running.**

**Have an authorized HYUNDAI dealer inspect the SRS as soon as possible if any of these conditions occur.**

During a moderate to severe frontal collision, sensors will detect the vehicle's rapid deceleration. If the rate of deceleration is high enough, the control unit will inflate the front air bags, at the time and with the force needed.

The front air bags help protect the driver and front passenger by responding to frontal impacts in which seat belts alone cannot provide adequate restraint. When needed, the side air bags help provide protection in the event of a side impact or rollover by supporting the side upper body area.

- Air bags are activated (able to inflate if necessary) only when the ignition switch is in the ON or START position, and it can be activated within about 3 minutes after the engine is turned off.
- Air bags inflate in the event of certain frontal or side collisions to help protect the occupants from serious physical injury.
- Generally, air bags are designed to inflate based upon the severity of a collision, its direction, or etc. These two factors determine whether the sensors produce an electronic deployment/inflation signal.
- The front air bags will completely inflate and deflate in an instant. It is virtually impossible for you to see the air bags inflate during an accident. It is much more likely that you will simply see the deflated air bags hanging out of their storage compartments after the collision.

- In addition to inflating in serious side collisions, vehicles equipped with a rollover sensor, side and curtain air bags will inflate if the sensing system detects a rollover.

When a rollover is detected, curtain air bags will remain inflated longer to help provide protection from ejection, especially when used in conjunction with the seat belts.

- To help provide protection, the air bags must inflate rapidly. The speed of air bag inflation is a consequence of extremely short time in which to inflate the air bag between the occupant and the vehicle structures before the occupant impacts those structures. This speed of inflation reduces the risk of serious or life-threatening injuries and is thus a necessary part of air bag design.

However, the rapid air bag inflation can also cause injuries which can include facial abrasions, bruises and broken bones because the inflation speed also causes the air bags to expand with a great deal of force.

- There are even circumstances under which contact with the air bag can cause fatal injuries, especially if the occupant is positioned excessively close to the air bag.

You can take steps to reduce the risk of being injured by an inflating air bag. The greatest risk is sitting too close to the air bag. An air bag needs about 10 in. (25 cm) of space to inflate. NHTSA recommends that drivers allow at least 10 in. (25 cm) between the center of the steering wheel and the chest.



### WARNING

**To reduce the risk of serious injury or death from an inflating air bag, take the following precautions:**

- **NEVER place a child restraint in the front passenger seat.**  
**Always properly restrain children under age 13 in the rear seats of the vehicle.**
- **Adjust the front passenger's and driver's seats as far to the rear as possible while allowing you to maintain full control of the vehicle.**
- **Hold the steering wheel with hands at the 9 o'clock and 3 o'clock positions.**
- **Never place anything or anyone between the air bag and the seat occupant.**
- **Do not allow the front passenger to place their feet or legs on the dashboard.**

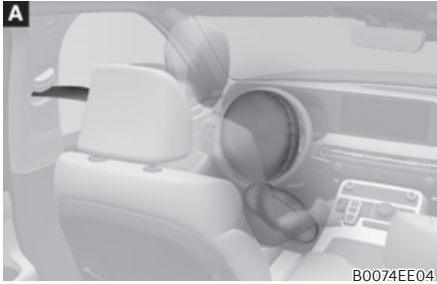

Ⓐ: Driver's front air bag (1)

When the SRSCM detects a sufficiently severe impact to the front of the vehicle, it will automatically deploy the front air bags.



Ⓑ: Driver's front air bag (2)

Upon deployment, tear seam molded directly into the pad cover will separate under pressure from the expansion of the air bags. Further opening of the covers allows full inflation of the air bags.

A fully inflated air bag, in combination with a properly worn seat belt, slows the driver's or the front passenger's forward motion, reducing the risk of head and chest injury.

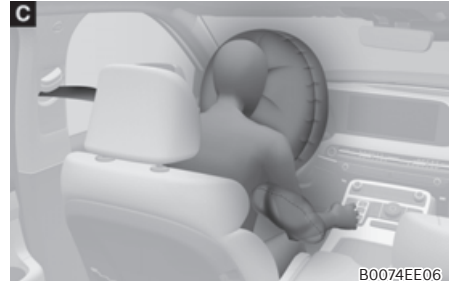

Ⓒ: Driver's front air bag (3)

Ⓓ: Passenger's front air bag

After complete inflation, the air bag immediately starts deflating, enabling the driver to maintain forward visibility and the ability to steer or operate other controls.

### **WARNING**

**To prevent objects from becoming dangerous projectiles when the passenger's air bag inflates:**

- **Do not install or place any objects (drink holder, CD holder, stickers, etc.) on the front passenger's panel above the glove box where the passenger's air bag is located.**
- **Do not install a container of liquid air freshener near the instrument cluster or on the instrument panel surface.**

## What to Expect After an Air Bag Inflates

After a frontal or side air bag inflates, it will deflate very quickly. Air bag inflation will not prevent the driver from seeing out of the windshield or being able to steer. Curtain air bags may remain partially inflated for some time after they deploy.



### WARNING

After an air bag inflates, take the following precautions:

- **Open your windows and doors as soon as possible after impact to reduce prolonged exposure to the smoke and powder released by the inflating air bag.**
- **Do not touch the air bag storage area's internal components immediately after an air bag has inflated. The parts that come into contact with an inflating air bag may be very hot.**
- **Always wash exposed skin areas thoroughly with cold water and mild soap.**
- **Always have an authorized HYUNDAI dealer replace the air bag immediately after deployment. Air bags are designed to be used only once.**

## Noise and smoke from inflating air bag

When the air bags inflate, they make a loud noise and may produce smoke and powder in the air inside of the vehicle. This is normal and is a result of the ignition of the air bag inflator. After the air bag inflates, you may feel substantial discomfort in breathing because of the contact of your chest with both the seat belt and the air bag, as well as from breathing the smoke and powder. The powder may aggravate asthma for some people. If you experience breathing problems after an air bag deployment, seek medical attention immediately.

Though the smoke and powder are nontoxic, they may cause irritation to the skin, eyes, nose, throat, etc. If this is the case, wash and rinse with cold water immediately and seek medical attention if the symptoms persist.

## Occupant Classification System (OCS)



Your vehicle is equipped with an Occupant Classification System (OCS) in the front passenger's seat.



### **Main components of the Occupant Classification System**

- A detection device located within the front passenger seat cushion.
- Electronic system to determine whether the passenger air bag systems should be activated or deactivated.
- An indicator light located on the overhead console which illuminates the words “PASSENGER AIR BAG OFF” indicating the front passenger air bag system is deactivated.
- The overhead console air bag indicator light is interconnected with the OCS.

The OCS is designed to help detect the presence of a properly-seated front passenger and determine if the passenger’s front air bag should be enabled (may inflate) or not.

The purpose is to help reduce the risk of injury or death from an inflating air bag to certain front passenger seat occupants, such as children, by requiring the air bag to be automatically turned OFF.

For example, if a child restraint of the type specified in the regulations is on the seat, the occupant classification sensor can detect it and cause the air bag to turn OFF.

Front passenger seat adult occupants who are properly seated and wearing the seat belt properly, should not cause the passenger air bag to be automatically turned OFF. For smaller adults it may turn OFF, however, if the occupant does not sit in the seat properly (for example, by not sitting upright, by sitting on the edge of the seat, or by otherwise being out of position), this could cause the sensor to turn the air bag OFF.

You will find the “PASSENGER AIR BAG OFF” indicator on the overhead console panel. This system detects the conditions 1-4 in the following table and activates or deactivates the front passenger air bag based on these conditions.

Always be sure that you and all vehicle occupants are seated properly and wearing the seat belt properly for the most effective protection by the air bag and the seat belt.

The OCS may not function properly if the passenger takes actions which can affect the classification system. These include:

- Failing to sit in an upright position.
- Leaning against the door or center console.
- Sitting towards the sides of the front of the seat.
- Putting their legs on the dashboard or resting them on other locations which reduce the passenger weight on the front seat.
- Wearing the seat belt improperly.
- Reclining the seatback.
- Wearing thick clothes like ski wear or hip protection wear.
- Putting an additional thick cushion on the seat.
- Putting electrical devices (for example, notebook, satellite radio) on the seat with inverter charging.

**Condition and operation in the front passenger Occupant Classification System**

Condition detected by the occupant classification system	Indicator/Warning light		Devices
	“PASSENGER AIR BAG OFF” indicator light	SRS warning light	Front passenger air bag
1. Adult *1	Off	Off	Activated
2. Infant *2 or child restraint system with 12 months old *3 *4	On	Off	Deactivated
3. Unoccupied	On	Off	Deactivated
4. Malfunction in the system	Off	On	Activated

\*1: The system judges a person of adult size as an adult. When a smaller adult sits in the front passenger seat, the system may recognize him/her as a child depending on his/her physique and posture.

\*2: Do not allow children to ride in the front passenger seat. When a larger child who has outgrown a child restraint system sits in the front passenger seat, the system may recognize him/her as an adult depending upon his/her physique or sitting position.

\*3: Never install a child restraint system on the front passenger seat.

\*4: The PASSENGER AIR BAG “OFF” indicator may turn on or off when a child above 12 months to 12 years old (with or without child restraint system) sits in the front passenger seat. This is a normal condition.

 **WARNING**

Riding in an improper position or placing weight on the front passenger's seat when it is unoccupied by a passenger adversely affects the OCS. To reduce the risk of serious injury or death:



- **NEVER** put a heavy load in the front seat or seatback pocket, or hang any items on the front passenger seat.



- **NEVER** place your feet on the front passenger seatback.



- **NEVER** sit with your hips shifted towards the front of the seat.



- **NEVER** ride with the seatback reclined when the vehicle is moving.



- **NEVER** place your feet or legs on the dashboard.



- **NEVER** lean on the door or center console or sit on one side of the front passenger seat.



- Do not sit on the passenger seat wearing heavily padded clothes such as ski wear and hip protector.



- Do not use car seat accessories such as thick blankets and cushions which cover up the car seat surface.



- Do not place electronic devices such as laptops, DVD player, or conductive materials such as water bottles on the passenger seat.
- Do not use electronic devices such as laptops and satellite radios which use inverter chargers.



- If large quantity of liquid has been spilled on the passenger seat, the air bag warning light may illuminate or malfunction.  
Therefore, make sure the seat has been completely dried before driving the vehicle.

- Do not place sharp objects on the front passenger seat. These may damage the occupant detection system, if they puncture the seat cushion.
- Do not place any items under the front passenger seat.
- When changing or replacing the seat or seat cover, use original items only. The OCS has been developed based on using original HYUNDAI car seats only. Altering or changing the authentic parts may result in system malfunction and increase risk of injury when in collision. Any of the above could interfere with the proper operation of the OCS sensor thereby increasing the risk of an injury in an accident.



B0073K003

### Proper seated position for OCS

If the “PASSENGER AIR BAG OFF” indicator is on when an adult is seated in the front passenger seat, place the ignition switch in the OFF position and ask the passenger to sit properly (sitting upright with the seat back in an upright position, centered on the seat cushion with their seat belt on, legs comfortably extended and their feet on the floor). Restart the engine and have the person remain in that position. This will allow the system to detect the person and to enable the passenger air bag. If the “PASSENGER AIR BAG OFF” indicator is still on, ask the passenger to move to the rear seat.



### WARNING

**NEVER** allow an adult passenger to ride in the front passenger seat when the “PASSENGER AIR BAG OFF” indicator is illuminated. During a collision, the air bag will not inflate if the indicator is illuminated. Have your passenger reposition themselves in the seat. If the “PASSENGER AIR BAG OFF” indicator remains illuminated after the passenger repositions themselves properly and the vehicle is restarted, have the passenger move to the rear seat because the air bag will not inflate.

### NOTICE

The “PASSENGER AIR BAG OFF” indicator generally illuminates for approximately 4 seconds after the ignition switch is in the ON or START position. But, if the ignition switch is placed to the ON or START position within 3 minutes after the engine is turned OFF, the indicator does not illuminate. If the front passenger seat is occupied, the OCS will then classify the front passenger after several more seconds.

**Do not install a Child Restraint System on the Front Passenger's Seat**



Even though your vehicle is equipped with the OCS, never install a child restraint in the front passenger's seat. An inflating air bag can forcefully strike a child or child restraint resulting in serious or fatal injury.

**WARNING**

- **NEVER** place a rearward-facing or forward-facing child restraint in the front passenger's seat of the vehicle.
- An inflating frontal air bag could forcefully strike a child resulting in serious injury or death.
- Always properly restrain children in an appropriate child restraint in the rear seat of the vehicle.

**Why Didn't My Air Bag Go Off in a Collision?**

There are certain types of accidents in which the air bag would not be expected to provide additional protection. These include rear impacts, second or third collisions in multiple impact accidents, as well as low speed impacts. Damage to the vehicle indicates a collision energy absorption, and is not an indicator of whether or not an air bag should have inflated.

**Air bag collision sensors**

**WARNING**

**To reduce the risk of an air bag deploying unexpectedly and causing serious injury or death:**

- Do not hit or allow any objects to impact the locations where air bags or sensors are installed.
- Do not perform maintenance on or around the air bag sensors. If the location or angle of the sensors is altered, the air bags may deploy when they should not or may not deploy when they should.
- Do not install bumper guards or replace the bumper with a non-genuine HYUNDAI parts. This may adversely affect the collision and air bag deployment performance.
- Place the ignition switch in the LOCK/OFF or ACC position when the vehicle is being towed to prevent inadvertent air bag deployment.
- Have all air bag repairs be conducted by an authorized HYUNDAI dealer.

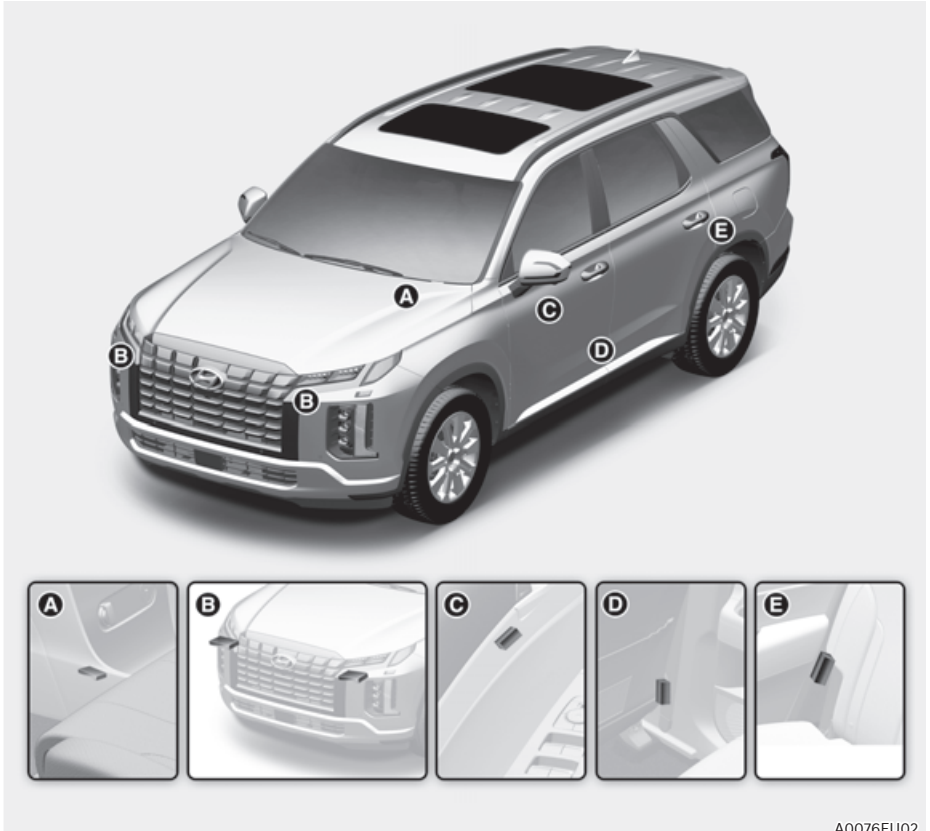

A0076EU02

- Ⓐ SRS control module / Rollover sensor
- Ⓑ Front impact sensor
- Ⓒ Side impact sensor (Pressure)

- Ⓓ Side impact sensor (Acceleration)
- Ⓔ Side impact sensor (Acceleration)

### **Air bag inflation conditions**



#### **Front air bags**

Front air bags are designed to inflate in a frontal collision depending on the severity of impact of the front collision.



#### **Side and curtain air bags**

Side and curtain air bags are designed to inflate when an impact is detected by side collision sensors depending on the severity of impact resulting from a side impact collision.

Although the driver's and front passenger's air bags are designed to inflate in frontal collisions, they also may inflate in other types of collisions if the front impact sensors detect a sufficient impact. Side and curtain air bags and front center air bag are designed to inflate in side impact collisions, but they may inflate in other collisions if the side impact sensors detect a sufficient impact.

Also, the side and curtain air bags are designed to inflate when a rollover is detected by a rollover sensor.

If the vehicle chassis is impacted by bumps or objects on unimproved roads, the air bags may deploy. Drive carefully on unimproved roads or on surfaces not designed for vehicle traffic to prevent unintended air bag deployment.



### ***Air bag non-inflation conditions***



In certain low-speed collisions the air bags may not deploy. The air bags are designed not to deploy in such cases because they may not provide benefits beyond the protection of the seat belts.



Front air bags are not designed to inflate in rear collisions, because occupants are moved backward by the force of the impact. In this case, inflated air bags would not provide any additional benefit.



Front air bags may not inflate in side impact collisions, because occupants move in the direction of the collision, and thus in side impacts, front air bag deployment would not provide additional occupant protection.

However, side and curtain air bags and front center air bag may inflate depending on the severity of impact.



In an angled collision, the force of impact may direct the occupants in a direction where the air bags would not be able to provide any additional benefit, and thus the sensors may not deploy any air bags.



Just before impact, drivers often brake heavily. Such heavy braking lowers the front portion of the vehicle causing it to “ride” under a vehicle with a higher ground clearance. Air bags may not inflate in this “underride” situation because deceleration forces that are detected by sensors may be significantly reduced by such “underride” collisions.



Front air bags may not inflate in rollover accidents because front air bag deployment would not provide additional occupant protection.

However, the side and curtain air bags and front center air bag may inflate in a rollover situation, when it is detected by the rollover sensor.



Air bags may not inflate if the vehicle collides with objects such as utility poles or trees, where the point of impact is concentrated and the collision energy is absorbed by the vehicle structure.

## SRS Care

The SRS is virtually maintenance-free and there are no parts you can safely service by yourself. If the SRS air bag warning light does not illuminate when the ignition switch is in the ON position, or continuously remains on, have your vehicle immediately inspected by an authorized HYUNDAI dealer.

Any work on the SRS system, such as removing, installing, repairing, or any work on the steering wheel, the front passenger's panel, front seats and roof rails must be performed by an authorized HYUNDAI dealer. Improper handling of the SRS system may result in serious personal injury.



## WARNING

**To reduce the risk of serious injury or death, take the following precautions:**

- **Do not attempt to modify or disconnect the SRS components or wiring, including the addition of any kind of badges to the pad covers or modifications to the body structure.**
- **Do not place objects over or near the air bag modules on the steering wheel, instrument panel, or the front passenger's panel above the glove box.**
- **Clean the air bag pad covers with a soft cloth moistened with plain water. Solvents or cleaners could adversely affect the air bag covers and proper deployment of the system.**
- **Always have inflated air bags replaced by an authorized HYUNDAI dealer.**
- **If components of the air bag system must be discarded, or if the vehicle must be scrapped, certain safety precautions must be observed. Consult an authorized HYUNDAI dealer for the necessary information. Failure to follow these precautions could increase the risk of personal injury.**

### Additional Safety Precautions

**Passengers should not move out of or change seats while the vehicle is moving.** A passenger who is not wearing a seat belt during a crash or emergency stop can be thrown against the inside of the vehicle, against other occupants, or be ejected from the vehicle.

**Do not use any accessories on seat belts.** Devices claiming to improve occupant comfort or reposition the seat belt can reduce the protection provided by the seat belt and increase the chance of serious injury in a crash.

**Do not modify the front seats.** Modification of the front seats could interfere with the operation of the supplemental restraint system sensing components or side air bags.

**Do not place items under the front seats.** Placing items under the front seats could interfere with the operation of the supplemental restraint system sensing components and wiring harnesses.

**Do not cause impact to the doors.** Impact to the doors when the ignition switch is in the ON or START position may cause the air bags to inflate.

**Modifications to accommodate disabilities.** If you require modification to your vehicle to accommodate a disability, contact the HYUNDAI Customer Connect Center at 800-633-5151.

### ***Adding equipment to or modifying your air bag equipped vehicle***

If you modify your vehicle by changing your vehicle's frame, bumper system, front end or side sheet metal or ride height, this may affect the operation of your vehicle's air bag system.

### Air Bag Warning Labels

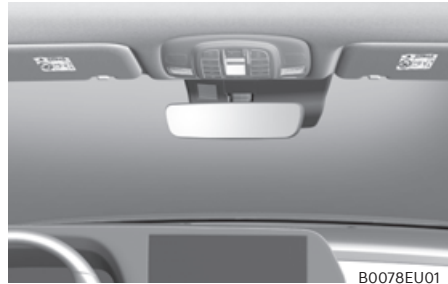

Air bag warning labels, required by the U.S. National Highway Traffic Safety Administration (NHTSA), are attached to alert the driver and passengers of potential risks of the air bag system. Be sure to read all of the information about the air bags that are installed on your vehicle in this Owners Manual.

# 4. Instrument Cluster

Instrument cluster .....	4-4
Instrument Cluster Control.....	4-5
Instrument panel illumination.....	4-5
Gauges and Meters .....	4-6
Speedometer .....	4-6
Tachometer .....	4-6
Engine coolant temperature gauge.....	4-7
Fuel gauge.....	4-7
Outside temperature gauge.....	4-8
Odometer .....	4-9
Distance to empty .....	4-9
Fuel economy (for 12.3-inch cluster) .....	4-10
Transmission Shift Indicator .....	4-10
Automatic transmission shift indicator .....	4-10
Warning and Indicator Lights .....	4-11
Seat belt warning light .....	4-11
Air bag warning light .....	4-11
Parking brake & Brake fluid warning light .....	4-11
Anti-lock Brake System (ABS) warning light .....	4-12
Electronic Brake Force Distribution (EBD) System Warning Light .....	4-12
Motor Driven Power Steering (MDPS) warning light .....	4-13
Charging system warning light .....	4-13
Engine Oil Pressure Warning Light .....	4-14
Engine coolant temperature warning light .....	4-14
Low fuel level warning light .....	4-14
Malfunction Indicator Lamp (MIL).....	4-15
Master warning light.....	4-15
Electronic Parking Brake (EPB) warning light .....	4-16
Low tire pressure warning light .....	4-16
Forward Safety warning light .....	4-17
Emergency Steering warning light .....	4-17
Lane Safety indicator light .....	4-18
All Wheel Drive (AWD) warning light .....	4-18
LED headlight warning light.....	4-18
Icy road warning light.....	4-19
Electronic Stability Control (ESC) indicator light.....	4-19
Electronic Stability Control (ESC) OFF indicator light.....	4-19
Immobilizer indicator light.....	4-20

Downhill Brake Control (DBC) indicator light .....	4-20
AUTO STOP indicator light .....	4-21
Turn signal indicator light .....	4-21
High beam indicator light .....	4-21
Low beam indicator light .....	4-21
Light ON indicator light .....	4-21
High Beam Assist indicator light.....	4-22
AUTO HOLD indicator light .....	4-22
LCD Display Messages.....	4-22
Vehicle is on .....	4-22
Shift to P .....	4-22
Vehicle is in N. Press START button and shift to P.....	4-22
Low key battery (for smart key system) .....	4-22
Press brake pedal to start engine .....	4-23
Key not in vehicle (for smart key system) .....	4-23
Key not detected (for smart key system) .....	4-23
Press START button again (for smart key system) .....	4-23
Press START button with digital key .....	4-23
Check BRAKE SWITCH fuse .....	4-23
Shift to P or N to start engine.....	4-23
Battery discharging due to external electrical devices.....	4-24
Press START button with key (for smart key system) .....	4-24
Place digital key on the wireless charger to keep the vehicle running.....	4-24
Vehicle is On (started by digital key).....	4-24
Place saved digital key on wireless charger, then press the START button.....	4-24
Scan an authorized fingerprint, then press the START button .....	4-24
Digital key(s) active.....	4-24
Door, Hood, Liftgate open indicator.....	4-25
Sunroof open indicator.....	4-25
Low tire pressure .....	4-25
Lights .....	4-26
Wiper .....	4-26
Low washer fluid .....	4-27
Low fuel .....	4-27
Low engine oil .....	4-27
Engine overheated.....	4-27
Check haptic steering wheel system .....	4-27
Check headlight.....	4-27
Check turn signal .....	4-27
Check headlight LED .....	4-27

# 4. Instrument Cluster

LCD Display .....	4-28
LCD Display Control .....	4-28
View Modes .....	4-29
Trip computer mode .....	4-30
Turn By Turn (TBT) mode .....	4-30
Driving Assist mode .....	4-31
Trip Computer (Type A) .....	4-32
Trip modes .....	4-32
Trip Computer (Type B) .....	4-34
Trip modes .....	4-34
Vehicle Settings (infotainment system) .....	4-37
Setting Your Vehicle .....	4-37

## INSTRUMENT CLUSTER

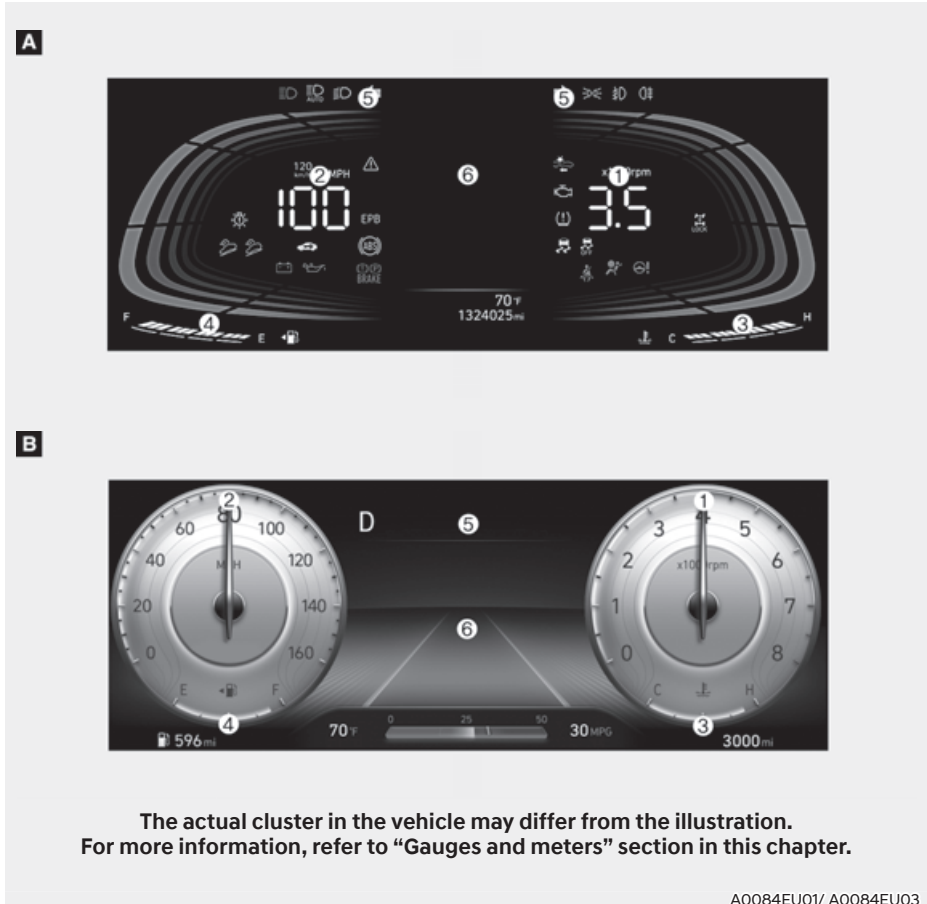

The actual cluster in the vehicle may differ from the illustration.  
For more information, refer to “Gauges and meters” section in this chapter.

A0084EU01/ A0084EU03

- 1. Tachometer
- 2. Speedometer
- 3. Engine coolant temperature gauge
- 4. Fuel gauge
- 5. Warning and indicator lights
- 6. LCD display



## Instrument Cluster Control

### Instrument panel illumination



#### Control switch (if equipped)

When the vehicle's position lights or headlights are on, press the illumination control switch to adjust the brightness of the instrument panel illumination. When pressing the illumination control switch, the interior switch illumination intensity is also adjusted. The brightness of the instrument panel illumination is displayed on the cluster LCD display. If the brightness reaches the maximum or minimum level, a chime will sound.

#### Infotainment system (if equipped)

You can adjust the brightness of the instrument panel illumination from the Settings menu in the infotainment system screen. Select :

- Setup → Vehicle → Cluster → Illumination

#### WARNING

Never adjust the instrument cluster while driving. This could result in loss of control and lead to an accident that may cause death, serious injury, or vehicle damage.

#### Information

- For safety reasons, the brightness of the instrument cluster lighting cannot not be adjusted below a certain level.
- The infotainment system may change after software updates. For more information, refer to the user's manual provided in the infotainment system and the quick reference guide.

## Gauges and Meters

### Speedometer



The speedometer indicates the speed of the vehicle and is calibrated in miles per hour (MPH) and/or kilometers per hour (km/h).

### Tachometer



The tachometer indicates the approximate number of engine revolutions per minute (RPM).

Use the tachometer to select the correct shift points and to help prevent lugging and/or over-revving the engine.

### **NOTICE**

**Do not operate the engine within the tachometer's RED ZONE. This may cause severe engine damage.**

### Engine coolant temperature gauge

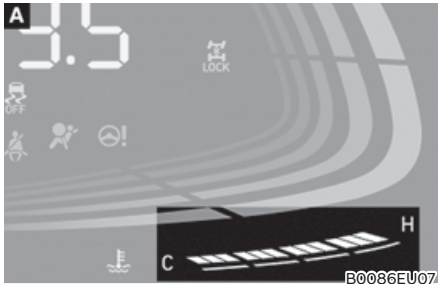

B0086EU07



B0086EU08

This gauge indicates the temperature of the engine coolant when the ignition switch is in the ON position.

#### NOTICE

If the gauge pointer moves beyond the normal range area toward the “H (Hot)” position, it indicates overheating that may damage the engine.

Do not continue driving with an overheated engine. If your vehicle overheats, refer to “If the Engine Overheats” section in chapter 8.

#### WARNING

Never remove the engine coolant reservoir cap when the engine is hot. The engine coolant is under pressure and could cause severe burn. Wait until the engine is cool before adding coolant to the reservoir.

### Fuel gauge



B0086EU09

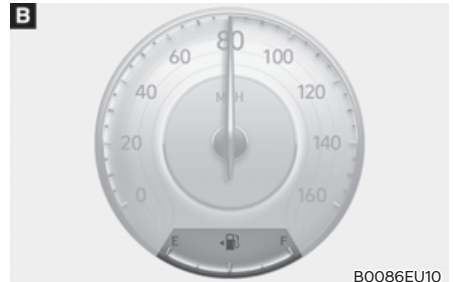

B0086EU10

This gauge indicates the approximate amount of fuel remaining in the fuel tank.

#### Information

- The fuel tank capacity is given in chapter 2.
- The fuel gauge is supplemented by a low fuel warning light, which will illuminate when the fuel tank is nearly empty.
- On inclines or curves, the fuel gauge pointer may fluctuate or the low fuel warning light may come on earlier than usual due to the movement of fuel in the tank.



## WARNING

Running out of fuel can expose vehicle occupants to danger.

You must stop and obtain additional fuel as soon as possible after the warning light comes on or when the gauge indicator comes close to the “E (Empty)” level.

## NOTICE

Avoid driving with an extremely low fuel level. Running out of fuel could cause the engine to misfire damaging the catalytic converter.

## Outside temperature gauge

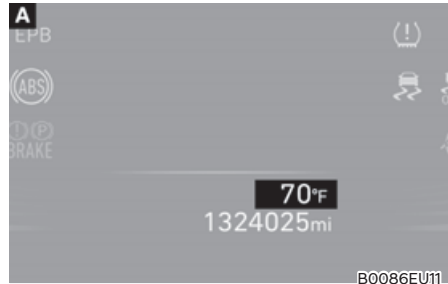

This gauge indicates the current outside air temperatures by increments of 1°F (1°C).

Note that the temperature indicated on the LCD display may not change as quickly as the outside temperature (there may be a slight delay before the temperature changes.)

You can change the temperature unit from the Settings menu in the infotainment system screen. Select:

- Setup → General Settings → Unit → Temperature Unit → °F/°C

Both the temperature unit on the cluster LCD display and climate control screen will change.



## Information

The infotainment system may change after software updates. For more information, refer to the user's manual provided in the infotainment system and the quick reference guide.

### Odometer

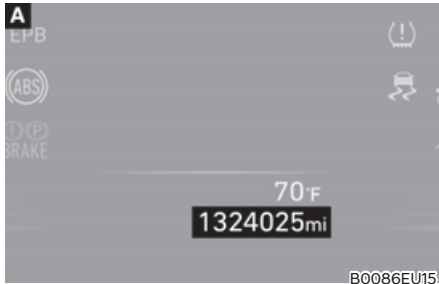

B0086EU15



B0086EU19

The odometer indicates the total distance that the vehicle has been driven and should be used to determine when periodic maintenance should be performed.

### Distance to empty



B0086EU20



B0086EU21

- The distance to empty is the estimated distance the vehicle can be driven with the remaining fuel.
- If the estimated distance is below 1 mi. (1 km), the trip computer will display “---” as distance to empty.

### **i** Information

- **If the vehicle is not on level ground or the battery power has been interrupted, the distance to empty function may not operate correctly.**
- **The distance to empty may differ from the actual driving distance as it is an estimate of the available driving distance.**
- **The trip computer may not register additional fuel if less than 2.4 gallons (9 liters) of fuel are added to the vehicle.**
- **The distance to empty may vary significantly based on driving conditions, driving habits, and condition of the vehicle.**

### Fuel economy (for type B cluster)



The average fuel economy ① and instant fuel economy ② is displayed at the bottom of the cluster.

#### Automatic reset

To automatically reset the average fuel economy, select between "After Ignition" or "After Refueling" from the Settings menu in the infotainment system screen.

### **i** Information

The infotainment system may change after software updates. For more information, refer to the user's manual provided in the infotainment system and the quick reference guide.

### Transmission Shift Indicator Automatic transmission shift indicator

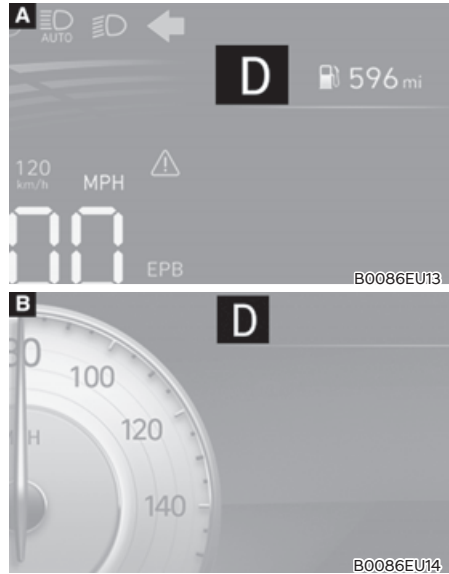

This indicator informs the current gear engaged.

## Warning and Indicator Lights

### **i** Information

**Make sure that all warning lights are OFF after starting the engine. If any light is still ON, this indicates a situation that needs attention.**

#### **Seat belt warning light**



This warning light informs the driver that the seat belt is not fastened.

For more details, refer to “Seat Belts” section in chapter 3.

#### **Air bag warning light**



**This warning light illuminates:**

- When you set the ignition switch to the ON position.
  - The air bag warning light illuminates for about 6 seconds and then turns off when all checks have been performed.
- The air bag warning light will remain illuminated if there is a malfunction with the Safety Restraint System (SRS) air bag operation.

If this occurs, have the vehicle inspected by an authorized HYUNDAI dealer.

#### **Parking brake & Brake fluid warning light**



**This warning light illuminates:**

- When you set the ignition switch to the ON position.
  - The parking brake & brake fluid warning light illuminates for about 3 seconds and will then turn off once the parking brake is released.
- Whenever the parking brake is applied.
- Whenever the brake fluid level in the reservoir is low.
  - If the warning light illuminates with the parking brake released, it indicates the brake fluid level in the reservoir is low.

**If the brake fluid level in the reservoir is low:**

1. Drive carefully to the nearest safe location and stop your vehicle.
2. With the engine stopped, check the brake fluid level immediately and add fluid as required (For more details, refer to “Brake Fluid” section in chapter 9). After adding brake fluid, check all brake components for fluid leaks. If a brake fluid leak is found, or if the warning light remains on, or if the brakes do not operate properly, do not drive the vehicle. Have the vehicle inspected by an authorized HYUNDAI dealer.

### Dual-diagonal braking system

Your vehicle is equipped with dual-diagonal braking system. This means you still have braking on two wheels even if one of the dual systems should fail.

With only one of the dual systems working, more than normal pedal travel and greater pedal pressure is required to stop the vehicle.

Also, the vehicle will not stop in as short a distance with only a portion of the brake system working.

If the brakes fail while you are driving, shift to a lower gear for additional engine braking and stop the vehicle as soon as it is safe to do so.



### WARNING

#### Parking Brake & Brake Fluid Warning Light

Driving the vehicle with a warning light ON is dangerous. If the Parking Brake & Brake Fluid Warning Light illuminates with the parking brake released, it indicates that the brake fluid level is low.

In this case, have the vehicle inspected by an authorized HYUNDAI dealer.

### Anti-lock Brake System (ABS) warning light



This warning light illuminates:

- When you set the ignition switch to the ON position.
  - The ABS warning light illuminates for about 3 seconds and then goes off.
- Whenever there is a malfunction with the ABS.

Note that the hydraulic braking system will still be operational even if there is a malfunction with the ABS. If the ABS warning light remains illuminated while driving, have the vehicle inspected by an authorized HYUNDAI dealer.

### Electronic Brake Force Distribution (EBD) System Warning Light



These two warning lights illuminate at the same time while driving:

When the ABS and regular brake system may not work normally.

In this case, have the vehicle inspected by an authorized HYUNDAI dealer.



**WARNING****Electronic Brake Force Distribution (EBD) System Warning Light**

When both ABS and Parking Brake & Brake Fluid Warning Lights are on, the brake system will not work normally and you may experience an unexpected and dangerous situation during sudden braking.

In this case, avoid high speed driving and abrupt braking.

Have the vehicle inspected by an authorized HYUNDAI dealer as soon as possible.

**Information - Electronic Brake Force Distribution (EBD) System Warning Light**

When the ABS Warning Light is on or both ABS and Parking Brake & Brake Fluid Warning Lights are on, the speedometer, odometer, or tripmeter may not work. Also, the EPS Warning Light may illuminate and the steering effort may increase or decrease.

In this case, have the vehicle inspected by an authorized HYUNDAI dealer as soon as possible.

**Motor Driven Power Steering (MDPS) warning light**

This warning light illuminates:

- When you set the ignition switch to the ON position.
  - The electric powering steering warning light illuminates for about 3 seconds and then goes off.
- Whenever there is a malfunction with the electric power steering.
 

If this occurs, have the vehicle inspected by an authorized HYUNDAI dealer.

**Charging system warning light**

This warning light illuminates:

When there is a malfunction with either the alternator or electrical charging system.

**If there is a malfunction with either the alternator or electrical charging system:**

1. Drive carefully to the nearest safe location and stop your vehicle.
2. Turn the engine off and check the alternator drive belt for looseness or breakage.

If the belt is adjusted properly, there may be a problem in the electrical charging system.

If this occurs, have the vehicle inspected by an authorized HYUNDAI dealer.

### **Engine Oil Pressure Warning Light**



**This warning light illuminates:**

When the engine oil pressure is low.

**If the engine oil pressure is low:**

1. Drive carefully to the nearest safe location and stop your vehicle.
2. Turn the engine off and check the engine oil level (For more information, refer to "Engine Oil" in chapter 9). If the level is low, add oil as required.

If the warning light remains on after adding oil or if oil is not available, have the vehicle inspected by an authorized HYUNDAI dealer as soon as possible. Continued driving with the warning light on may cause engine failure.

#### **NOTICE**

**If the engine is not stopped immediately after the Engine Oil Pressure warning light is illuminated, severe damage could result.**

### **Engine coolant temperature warning light (if equipped)**



**The warning light illuminates:**

When the temperature of the engine coolant is extremely high.

Do not continue driving with an overheated engine. If your vehicle overheats, refer to "Overheating" section in chapter 8.

#### **NOTICE**

**If the Engine Coolant Temperature warning light illuminates, it indicates overheating that may damage the engine.**

### **Low fuel level warning light**



**This warning light illuminates:**

When the fuel tank is nearly empty. Add fuel as soon as possible.

#### **NOTICE**

**Driving with the Low Fuel Level warning light on or with the fuel level below "E (Empty)" can cause the engine to misfire and damage the catalytic converter.**

### **Malfunction Indicator Lamp (MIL)**



**This indicator light illuminates:**

- When you set the ignition switch to the ON position.
  - The malfunction indicator light illuminates for about 3 seconds and then goes off.
- Whenever there is a malfunction with either the emission control system or the engine or the vehicle powertrain.

If this occurs, have the vehicle inspected by an authorized HYUNDAI dealer.

#### **NOTICE**

**Driving with the Malfunction Indicator Lamp (MIL) on may cause damage to the emission control system which could affect drivability and/or fuel economy.**

#### **NOTICE**

**If the Malfunction Indicator Lamp (MIL) illuminates, potential catalytic converter damage is possible which could result in loss of engine power.**

**If this occurs, have the vehicle inspected by an authorized HYUNDAI dealer.**

### **Master warning light**



**This warning light illuminates:**

When there is a malfunction in operation in any of the following systems:

- Forward Collision-Avoidance Assist malfunction
- Forward Collision-Avoidance Assist radar blocked
- Blind-spot Collision Warning malfunction (if equipped)
- Blind-spot Collision Warning radar blocked (if equipped)
- LED headlight malfunction (if equipped)
- High Beam Assist malfunction (if equipped)
- Smart Cruise Control malfunction (if equipped)
- Smart Cruise Control radar blocked (if equipped)
- Tire Pressure Monitoring System (TPMS) malfunction
- Electronic Limited Slip Differential (e-LSD) malfunction (if equipped)

To identify the details of the warning, look at the LCD display.

### **Electronic Parking Brake (EPB) warning light**

## **EPB**

**This warning light illuminates:**

- When you set the ignition switch to the ON position.
  - The EPB warning light illuminates for about 3 seconds and then goes off.
- Whenever there is a malfunction with EPB.

If this occurs, have the vehicle inspected by an authorized HYUNDAI dealer.

### **Information**

**The Electronic Parking Brake (EPB) warning light may illuminate when the Electronic Stability Control (ESC) indicator light comes on to indicate that ESC is not working properly. This does not indicate malfunction of EPB.**

### **Low tire pressure warning light**



**This warning light illuminates:**

- When you set the ignition switch to the ON position.
  - The low tire pressure warning light illuminates for approximately 3 seconds and then goes off.
- When one or more of your tires are significantly underinflated. (The location of the underinflated tires are displayed on the LCD display.)

For more details, refer to “Tire Pressure Monitoring System (TPMS)” section in chapter 8.

**This warning light remains ON after blinking for approximately 60 seconds, or repeatedly blinks ON and OFF in 3 second intervals:**

When there is a malfunction with the TPMS.

If this occurs, have the vehicle inspected by an authorized HYUNDAI dealer as soon as possible.

For more details, refer to “Tire Pressure Monitoring System (TPMS)” section in chapter 8.

### **WARNING**

#### **Safe Stopping**

- **The TPMS cannot alert you to severe and sudden tire damage caused by external factors.**
- **If you notice any vehicle instability, immediately take your foot off the accelerator pedal, apply the brakes gradually with light force, and slowly move to a safe position off the road.**

**Forward Safety warning light****This warning light illuminates:**

- When you set the ignition switch to the ON position.
  - The Forward Safety warning light illuminates for approximately 3 seconds and then goes off.
- [Continuously Yellow] When Forward safety/Forward cross-traffic safety of Forward Collision-Avoidance Assist is Off/Disabled/Malfunction.
- [Blinking Red] When Forward safety/Forward cross-traffic safety of Forward Collision-Avoidance Assist is operating

If this occurs, have the vehicle inspected by an authorized HYUNDAI dealer as soon as possible.

For more details, refer to “Forward Collision-Avoidance Assist (FCA)” section in chapter 7.

**Emergency Steering warning light****This warning light illuminates:**

- When you set the ignition switch to the ON position.
  - The steering safety warning light illuminates for approximately 3 seconds and then goes off.
- [Continuously Yellow] When Forward/side safety of Forward Collision-Avoidance Assist is Off/Disabled/Malfunction.
- [Blinking Red] When Forward/side safety of Forward Collision-Avoidance Assist is operating

If this occurs, have the vehicle inspected by an authorized HYUNDAI dealer as soon as possible.

For more details, refer to “Forward Collision-Avoidance Assist (FCA)” section in chapter 7.

### **Lane Safety indicator light**



#### **This indicator light illuminates:**

- [Green] When Lane Keeping Assist operating conditions are satisfied.
- [Grey] When Lane Keeping Assist operating conditions are not satisfied.
- [Yellow] Whenever there is a malfunction with Lane Keeping Assist. If this occurs, have the vehicle inspected by an authorized HYUNDAI dealer as soon as possible.

For more details, refer to "Lane Keeping Assist (LKA)" section in chapter 7.

### **All Wheel Drive (AWD) warning light (if equipped)**



#### **This warning light illuminates:**

Whenever there is a malfunction with the AWD system.

If this occurs, have the vehicle inspected by an authorized HYUNDAI dealer as soon as possible.

For more details, refer to "All Wheel Drive (AWD)" section in chapter 6.

### **LED headlight warning light (if equipped)**



#### **This warning light illuminates:**

- When you set the ignition switch to the ON position.
  - The LED headlight warning light illuminates for approximately 3 seconds and then goes off.
- Whenever there is a malfunction with the LED headlight.

If this occurs, have the vehicle inspected by an authorized HYUNDAI dealer as soon as possible.

#### **This warning light blinks:**

Whenever there is a malfunction with a LED headlight related part.

If this occurs, have the vehicle inspected by an authorized HYUNDAI dealer as soon as possible.

### **NOTICE**

**Continuous driving with the LED Headlight warning light on or blinking can reduce LED headlight life.**

### ***Icy road warning light (if equipped)***



This warning light is to warn the driver the road may be icy.

When the temperature on the outside temperature gauge is approximately below 40°F (4°C), the Icy Road warning light and Outside Temperature Gauge blinks and then illuminates. Also, the warning chime sounds 1 time.

You can activate or deactivate the Icy Road Warning function from the Settings menu in the instrument cluster or infotainment system. Select:

- User Settings → Cluster → Icy Road Warning (for cluster type)
- Setup → Vehicle → Cluster → Content Selection → Icy Road Warning (for infotainment system type)



### **Information**

- **If the Icy Road warning light appears while driving, you should drive more attentively and safely refraining from over-speeding, rapid acceleration, sudden braking or sharp turning, etc.**
- **The infotainment system may change after software updates. For more information, refer to the user's manual provided in the infotainment system and the quick reference guide.**

### ***Electronic Stability Control (ESC) indicator light***



**This indicator light illuminates:**

- When you set the ignition switch to the ON position.
  - The Electronic Stability Control indicator light illuminates for about 3 seconds and then goes off.
- Whenever there is a malfunction with ESC system.

If this occurs, have the vehicle inspected by an authorized HYUNDAI dealer as soon as possible.

**This indicator light blinks:**

While ESC is operating.

**For more details, refer to “Electronic Stability Control (ESC)” section in chapter 6.**

### ***Electronic Stability Control (ESC) OFF indicator light***



**This indicator light illuminates:**

- When you set the ignition switch to the ON position.
  - The ESC OFF indicator light illuminates for approximately 3 seconds and then goes off.
- When you deactivate ESC system by pressing the ESC OFF button.

For more details, refer to “Electronic Stability Control (ESC)” section in chapter 6.

### **Immobilizer indicator light**



**This indicator light illuminates for up to 30 seconds:**

When the vehicle detects the smart key in the vehicle with the ignition switch in the ACC or ON position.

- Once the smart key is detected, you can start the engine.
- The indicator light goes off after starting the engine.

**This indicator light blinks for a few seconds:**

When the smart key is not in the vehicle.

- If the smart key is not detected, you cannot start the engine.

**This indicator light illuminates for 2 seconds and goes off:**

If the smart key is in the vehicle and the ignition switch is ON, but the vehicle cannot detect the smart key.

If this occurs, have the vehicle inspected by an authorized HYUNDAI dealer as soon as possible.

**This indicator light blinks:**

Whenever there is a malfunction with the immobilizer system.

If this occurs, have the vehicle inspected by an authorized HYUNDAI dealer as soon as possible.

### **Downhill Brake Control (DBC) indicator light (if equipped)**



**This indicator light illuminates:**

- When you set the ignition switch to the ON position.
  - The downhill brake control indicator light illuminates for about 3 seconds and then goes off.
- When you activate the system by pressing the DBC button.

**This indicator light blinks:**

When Downhill Brake Control system is operating.

**This indicator light illuminates yellow:**

Whenever there is a malfunction with Downhill Brake Control system.

If this occurs, have the vehicle inspected by an authorized HYUNDAI dealer as soon as possible.

For more details, refer to "Downhill Brake Control (DBC)" section in chapter 6.



**AUTO STOP indicator light  
(if equipped)**

**This indicator light illuminates:**

- [White] When the system operating conditions are satisfied.
- [Green] When the ISG system is activated.
- [Yellow] Whenever there is a malfunction with the ISG function.

If this occurs, have the vehicle inspected by an authorized HYUNDAI dealer as soon as possible.

For more details, refer to "ISG (Idle Stop and Go) system" section in chapter 6.

**Information**

**When the engine automatically starts by the ISG system, some warning lights (ABS, ESC, ESC OFF, EPS or Parking brake warning light) may turn on for a few seconds. This happens because of low battery voltage. It does not mean the system has malfunctioned.**

**Turn signal indicator light**

**This indicator light blinks:**

When you operate the turn signal indicator stalk.

If any of the following occur, there may be a malfunction with the turn signal system.

- The turn signal indicator light illuminates but does not blink
- The turn signal indicator light blinks rapidly
- The turn signal indicator light does not illuminate at all

If this occurs, have the vehicle inspected by an authorized HYUNDAI dealer as soon as possible.

**High beam indicator light**

**This indicator light illuminates:**

- When the headlights are on and in the high beam position
- When the turn signal lever is pulled into the Flash-to-Pass position.

**Low beam indicator light**

**This indicator light illuminates:**

When the headlights are on.

**Light ON indicator light**

**This indicator light illuminates:**

When the position lamps or headlights are on.

### **High Beam Assist indicator light**



#### **This indicator light illuminates:**

When the high-beam is on with the light switch in the AUTO position.

- White: When High Beam Assist is ready to operate.
- Green: When High Beam Assist is operating.

If your vehicle detects oncoming or preceding vehicles, High Beam Assist will switch the high beam to low beam automatically.

For more details, refer to “High Beam Assist (HBA)” section in chapter 5.

### **AUTO HOLD indicator light**



#### **This indicator light illuminates:**

- [White] When you activate Auto Hold by pressing the AUTO HOLD switch.
- [Green] When you stop the vehicle completely by depressing the brake pedal with Auto Hold activated.
- [Yellow] Whenever there is a malfunction with the Auto Hold function.

If this occurs, have the vehicle inspected by an authorized HYUNDAI dealer as soon as possible.

For more details, refer to “Electronic Parking Brake (EPB)” section in chapter 6.

## **LCD Display Messages**

### **Vehicle is on**

This message is displayed if you open the driver’s door when the gear is in P (Park) and the ignition switch in the ON or START position.

Turn the engine off before leaving the vehicle.

### **Shift to P**

This message is displayed if you try to turn off the vehicle without the gear in the P (Park) position.

If this occurs, the ignition switch places to the ACC position.

### **Vehicle is in N. Press START button and shift to P (if equipped)**

This message is displayed if you try to turn off the vehicle with the gear in N (Neutral).

To turn off the vehicle:

1. Press the Engine Start/Stop button. The button will change to the ON position.
2. Press the P button to shift to P (Park).
3. Press the Engine Start/Stop button again, then the vehicle will turn off.

### **Low key battery (for smart key system)**

This message is displayed if the battery of the smart key is discharged while changing the ignition switch to the OFF position.

***Press brake pedal to start engine***

This message is displayed if the ignition switch changes to the ACC position twice by pressing the button repeatedly without depressing the brake pedal.

You can start the vehicle by depressing the brake pedal and then placing the ignition switch.

***Key not in vehicle (for smart key system)***

This message is displayed if the smart key is not in the vehicle when you leave the vehicle with the ignition switch in the ON or Start position.

Always turn off the engine before leaving your vehicle.

***Key not detected (for smart key system)***

This message is displayed if the smart key is not detected when you place the ignition switch.

***Press START button again (for smart key system)***

This message is displayed if you were unable to start the vehicle when the Engine Start/Stop button was pressed.

If this occurs, attempt to start the engine by pressing the Engine Start/Stop button again.

If the warning message appears each time you press the Engine Start/Stop button, have your vehicle inspected by an authorized HYUNDAI dealer.

***Press START button with digital key***

This message is displayed if you press the Engine Start/Stop button while the warning message “Key not detected” is displayed.

At this time, the immobilizer indicator light blinks.

***Check BRAKE SWITCH fuse***

This message is displayed if the brake switch fuse is disconnected.

You need to replace the fuse with a new one before starting the engine.

If that is not possible, you can start the engine by pressing the Engine Start/Stop button for 10 seconds in the ACC position.

***Shift to P or N to start engine***

This message is displayed if you try to start the engine in any other position except P (Park) or N (Neutral).

***i* Information**

**You can start the engine with the gear in N (Neutral). But, for your safety, we recommend that you start the engine with the gear shifted to P (Park).**

**Battery discharging due to external electrical devices (if equipped)**

This message is displayed if the battery voltage is weak due to any non-factory electrical accessories (ex. dashboard camera) while parking. Be careful that the battery is not discharged.

If the warning message appears after removing the non-factory electrical accessories, have the vehicle inspected by an authorized HYUNDAI dealer.

**Press START button with key (for smart key system)**

This warning message is displayed if you press the Engine Start/Stop button while the warning message "Key not detected" is displayed.

At this time, the immobilizer indicator light blinks.

**Place digital key on the wireless charger to keep the vehicle running**

If the vehicle is remotely started and 'Start Vehicle' is deselected from the Settings menu in the infotainment system screen for Driver 1 and Driver 2, this message will be displayed for up to 30 seconds when a door is opened after unlocking the doors with a digital key.

To drive your vehicle, place the registered digital key on the wireless charger, when this message appears.

**Vehicle is On (started by digital key)**

This message is displayed for up to 10 seconds if the driver's door is opened without the driver's seat belt fastened after turning on the engine with a digital key. After the message is displayed, a warning sounds when the door is closed.

**Place saved digital key on wireless charger, then press the START button**

This message is displayed for 6 seconds and the immobilizer indicator light () will blink for 10 seconds after the message "Press START button with key" is displayed for 4 seconds if the smart key is not in the vehicle or not detected, or the digital key is not placed on the wireless charger when you press the Engine Start/Stop button. To start the vehicle, place a registered digital key on the wireless charger, and then press the Engine Start/Stop button.

**Scan an authorized fingerprint, then press the START button**

This message is displayed for 6 seconds and the immobilizer indicator light () will blink for 10 seconds after the message "Press START button with key" is displayed for 4 seconds if the smart key is not in the vehicle or not detected, or your fingerprint is not verified when you press the Engine Start/Stop button. To start the vehicle, have an authorized fingerprint verified on the fingerprint sensor, and then press the Engine Start/Stop button.

**Digital key(s) active**

This message is displayed for 4 seconds when a smartphone key or NFC card key is registered, and vehicle doors are locked and unlocked after more than 10 minutes and the ignition switch is placed to the ON position. The message is not displayed again until more than 10 minutes have passed after the doors are relocked.

** Information**

Since the engine was started with a digital key, if the engine is turned off, and there is no smart key or digital key in the vehicle, it may be difficult to start the engine again.

**Door, Hood, Liftgate open indicator**

B0088KO01

This warning is displayed if any door or hood or liftgate is left open. The warning will indicate which door is open in the display.

**CAUTION**

Before driving the vehicle, you should confirm that the door/hood/liftgate are fully closed.

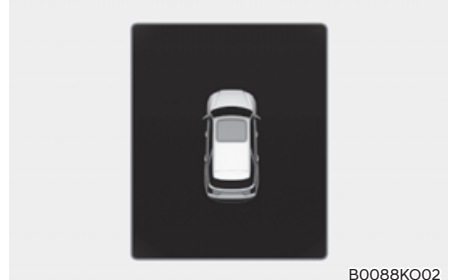
**Sunroof open indicator (if equipped)**

B0088KO02

This warning is displayed if you turn off the engine when the sunroof is open. Close the sunroof securely before leaving your vehicle.

**Low tire pressure**

B0088EU07

This warning message is displayed if the tire pressure is low. The corresponding tire on the vehicle will be illuminated.

For more details, refer to "Tire Pressure Monitoring System (TPMS)" section in chapter 8.

### Lights

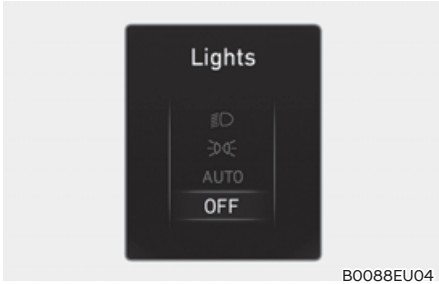

B0088EU04

This indicator displays which exterior light is selected using the lighting control.

You can activate or deactivate Wiper/Lights display function from the Settings menu in the infotainment system. Select:

- Setup → Vehicle → Cluster → Content Selection → Wiper/Lights Display

### **i** Information

**The infotainment system may change after software updates. For more information, refer to the user's manual provided in the infotainment system and the quick reference guide.**

### Wiper



B0088EU05

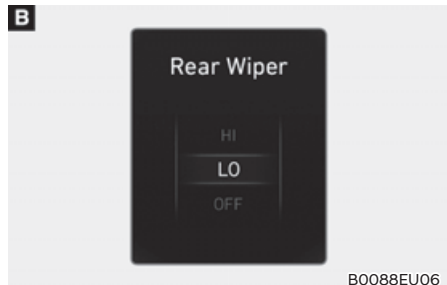

B0088EU06

Ⓐ: Front, Ⓑ: Rear

This indicator displays which wiper speed is selected using the wiper control.

You can activate or deactivate Wiper/Lights display function from the Settings menu in the infotainment system. Select:

- Setup → Vehicle → Cluster → Content Selection → Wiper/Lights Display

### **i** Information

**The infotainment system may change after software updates. For more information, refer to the user's manual provided in the infotainment system and the quick reference guide.**

**Low washer fluid**

This message is displayed if the washer fluid level in the reservoir is nearly empty. Have the washer fluid reservoir refilled.

**Low fuel**

This message is displayed if the fuel tank is almost out of fuel.

When this message is displayed, the low fuel level warning light in the cluster will come on.

It is recommended to look for the nearest fueling station and refuel as soon as possible.

**Low engine oil (if equipped)**

This warning message is displayed when the engine oil level should be checked.

If this warning message is displayed, check the engine oil level as soon as possible and add engine oil as required.

Slowly pour the recommended oil little by little into a funnel.

Use only the specified engine oil. (Refer to "Recommended Lubricants and Capacities" section in chapter 2.)

Do not overfill the engine oil. Make sure the oil level is not above F (Full) mark on the dipstick.

**Information**

**After adding engine oil, if you travel approximately 31~62 miles (50~100 km) after the engine warms up, the warning message should disappear.**

**If the warning message remains on, have the vehicle inspected by an authorized HYUNDAI dealer as soon as possible.**

**Engine overheated**

This message is displayed when the engine coolant temperature is above approximately 248°F (120°C). This means that the engine is overheated and may be damaged.

**If your vehicle is overheated, refer to "Overheating" section in chapter 8.**

**Check haptic steering wheel system**

This message is displayed if there is a problem with the haptic steering wheel system. Have the vehicle inspected by an authorized HYUNDAI dealer.

**Check headlight**

This message is displayed if the headlights are not operating properly. A lamp may need to be replaced.

Make sure to replace the burned out bulb with a new one of the same wattage rating.

**Check turn signal**

This message is displayed if the turn signal lamps are not operating properly. A lamp may need to be replaced.

Make sure to replace the burned out bulb with a new one of the same wattage rating.

**Check headlight LED (if equipped)**

This message is displayed if there is a problem with the LED headlight. Have the vehicle inspected by an authorized HYUNDAI dealer.



## LCD DISPLAY

### LCD Display Control



B0090K001

The LCD display modes can be changed by using the control buttons.







Switch	Function
	MODE button for changing modes
	MOVE switch for changing items
OK	SELECT/RESET button for setting or resetting the selected item

### Information

**If equipped with an infotainment system, only the Settings menu in the infotainment system is supported and not the instrument cluster.**



## View Modes

View modes	Symbol	Explanation
Driving Assist		This mode displays the state of : <ul style="list-style-type: none"> <li>- Lane Keeping Assist</li> <li>- Smart Cruise Control</li> <li>- Highway Driving Assist</li> </ul> For more information, refer to "Lane Keeping Assist (LKA)", "Smart Cruise Control (SCC)", "Highway Driving Assist (HDA)" in chapter 7.
Trip Computer		This mode displays driving information such as the tripmeter, fuel economy, etc. For more details, refer to "Trip Computer" in this chapter.
Turn By Turn (TBT)		This mode displays the state of the navigation.
User Settings		In this mode, you can change settings of the doors, lamps, etc.
Warning/ Vehicle Information		This mode displays warning messages related to the lamp malfunction, etc. This mode displays information related to the tire pressure monitoring system (TPMS), the state of driving force distribution (AWD) and the amount of remaining urea solution.
Tire Pressure Setting		In this mode, you can reset the tire pressure monitoring system (TPMS). If warning occurs, the symbol changes to the warning mode symbol.

**The information provided may differ depending on which functions are applicable to your vehicle.**

**Trip computer mode**

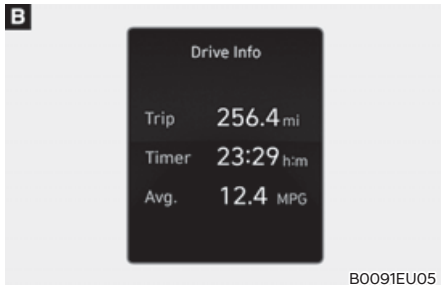
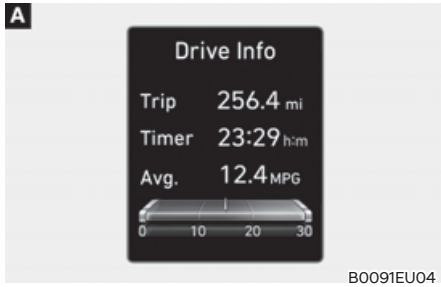

The trip computer mode displays information related to vehicle driving parameters including fuel economy, tripmeter information and vehicle speed.

For more information, refer to "Trip Computer" in this chapter.

**Turn By Turn (TBT) mode**

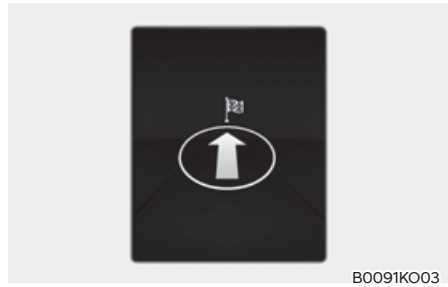

Turn-by-turn navigation, distance/time to destination information is displayed when Turn by Turn view is selected.

### Driving Assist mode



B0091KO02

#### LKA/SCC/HDA

This mode displays the state of Lane Keeping Assist, Smart Cruise Control, and Highway Driving Assist.

For more details, refer to each system information in chapter 7.

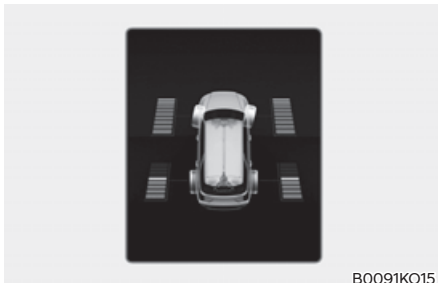

B0091KO15

#### Driving force distribution (AWD) (if equipped)

This mode displays information related to AWD driving force.

If the vehicle is in AWD lock state, this mode is not displayed.

For detailed information, refer to the "All Wheel Drive" in the chapter 6.



B0091EU12

#### Tire Pressure

This mode displays information related to Tire Pressure.

For more details, refer to "Tire Pressure Monitoring System (TPMS)" in chapter 8.

## Trip Computer (Type A)

The trip computer is a microcomputer-controlled driver information system that displays information related to driving.

### **i** Information

Some driving information stored in the trip computer (for example, Average Vehicle Speed) resets if the battery is disconnected.

#### Trip modes

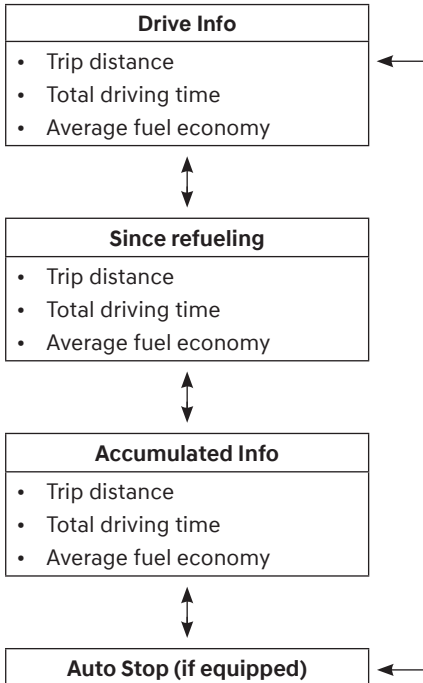

To change the trip mode, toggle the " $\wedge$ ,  $\vee$ " switch on the steering wheel

- Manual reset
    - To clear the average fuel economy manually, press the OK switch on the steering wheel for more than 1 second when the Average Fuel Economy is displayed.
  - Automatic reset
    - To automatically reset the average fuel economy, select between 'After Ignition' or 'After Refueling' from the Settings menu in the instrument cluster.
      - After Ignition: When the engine has been OFF for 3 minutes or longer the average fuel economy will reset automatically.
      - After Refueling: The average fuel economy will reset automatically after adding 6 liters (1.6 gallons) of fuel or more and after driving speed exceeds 1 mph (1 km/h).
- \* For 10.25-inch instrument cluster, you can check the fuel economy in the center bottom of the cluster.



B0802EU01

### Drive info

Trip distance ①, total driving time ② and average fuel economy ③ are displayed.

The information is combined for each ignition cycle. However, when the engine has been OFF for 3 minutes or longer the Drive Info screen will reset.

To reset manually, press the OK switch on the steering wheel for more than 1 second when 'Drive Info' is displayed.

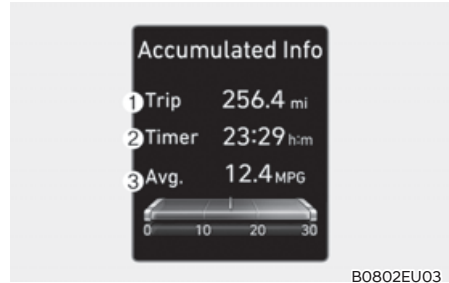

B0802EU03

### Accumulated info

Accumulated trip distance ①, total driving time ② and average fuel economy ③ are displayed.

The information is accumulated starting from the last reset.

To reset manually, press the OK switch on the steering wheel for more than 1 second when 'Accumulated Info' is displayed.



B0802EU02

### Since refueling

Trip distance ①, total driving time ② and average fuel economy ③ after the vehicle has been refueled are displayed.

To reset manually, press the OK switch on the steering wheel for more than 1 second when 'Since Refueling' is displayed.

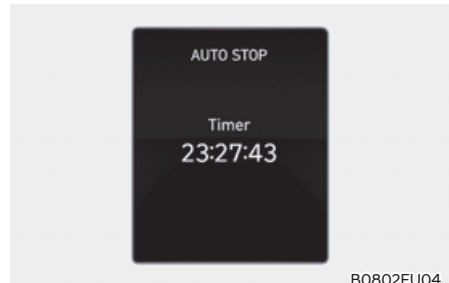

B0802EU04

### Auto stop (if equipped)

AUTO STOP display shows the elapsed time of engine stop by Idle Stop and Go system.

For more details, refer to "Idle Stop and Go (ISG)" section in chapter 6.

### Trip Computer (Type B)

The trip computer is a microcomputer-controlled driver information system that displays information related to driving.

#### **i** Information

Some driving information stored in the trip computer (for example, Average Vehicle Speed) resets if the battery is disconnected.

#### Trip modes

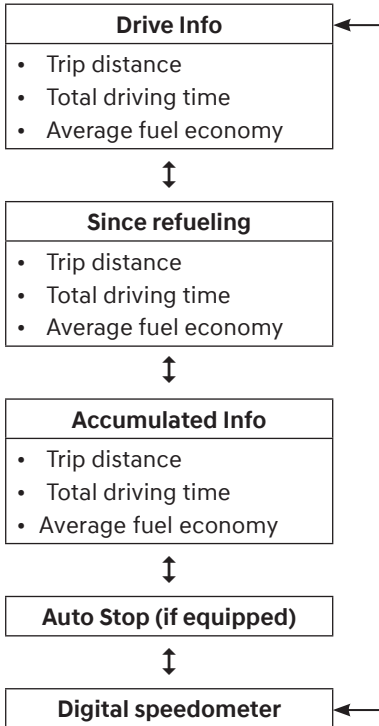

To change the trip mode, toggle the "∧, ∨" switch on the steering wheel

- Manual reset
    - To clear the average fuel economy manually, press the OK switch on the steering wheel for more than 1 second when the Average Fuel Economy is displayed.
  - Automatic reset
    - To automatically reset the average fuel economy, select between 'After Ignition' or 'After Refueling' from the Settings menu in the instrument cluster.
      - After Ignition: When the engine has been OFF for 3 minutes or longer the average fuel economy will reset automatically.
      - After Refueling: The average fuel economy will reset automatically after adding 1.6 gallons (6 liters) of fuel or more and after driving speed exceeds 1 mph (1 km/h).
- \* For 10.25-inch instrument cluster, you can check the fuel economy in the center bottom of the cluster.

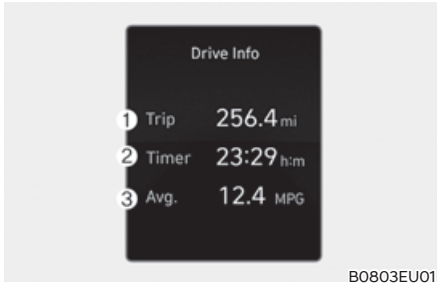

B0803EU01

### Drive info

Trip distance ①, total driving time ② and average fuel economy ③ are displayed.

The information is combined for each ignition cycle. However, when the engine has been OFF for 3 minutes or longer the Drive Info screen will reset.

To reset manually, press the OK switch on the steering wheel for more than 1 second when 'Drive Info' is displayed.

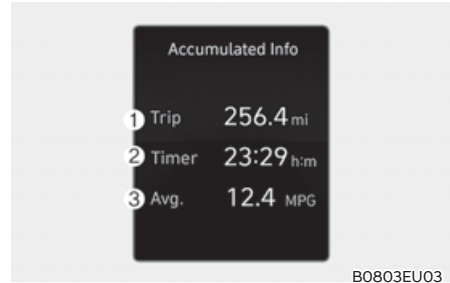

B0803EU03

### Accumulated info

Accumulated trip distance ①, total driving time ② and average fuel economy ③ are displayed.

The information is accumulated starting from the last reset.

To reset manually, press the OK switch on the steering wheel for more than 1 second when 'Accumulated Info' is displayed.

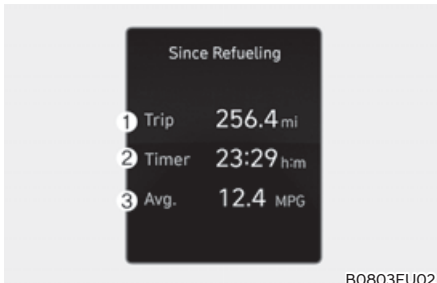

B0803EU02

### Since refuel(l)ing

Trip distance ①, total driving time ② and average fuel economy ③ are displayed.

To reset manually, press the OK switch on the steering wheel for more than 1 second when 'Since Refueling' is displayed.

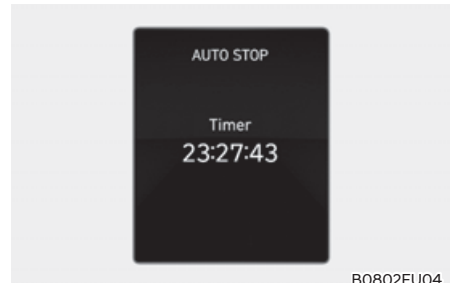

B0802EU04

### Auto stop (if equipped)

AUTO STOP display shows the elapsed time of engine stop by Idle Stop and Go system.

For more details, refer to "Idle Stop and Go (ISG)" section in chapter 6.

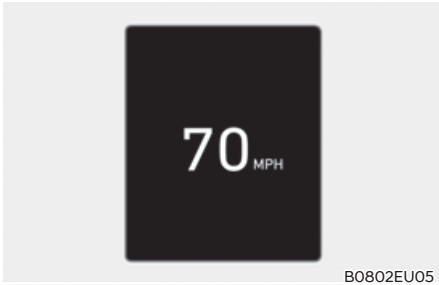

**Digital speedometer**

Digital speedometer display shows the speed of the vehicle.



## VEHICLE SETTINGS (INFOTAINMENT SYSTEM)



B0094EU01

Vehicle Settings in the infotainment system provides user options for a variety of settings including door lock/unlock features, convenience features, driver assistance settings, etc.

### Vehicle Settings menu

- Driver Assistance
- Drive Mode
- Head-Up Display
- Cluster
- Climate
- Seat
- Lights
- Door
- Digital key
- Convenience

These options may differ depending on which functions are available on your vehicle.



### WARNING

**Do not operate the Vehicle Settings while driving. This may cause distraction resulting in an accident.**

## Setting Your Vehicle



B0095K001

1. Press the SETUP button on the head unit of the infotainment system.

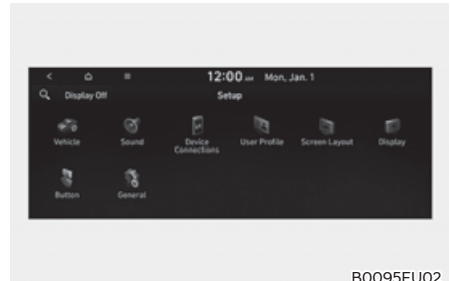

B0095EU02

2. Select 'Vehicle' to change the Vehicle Settings.

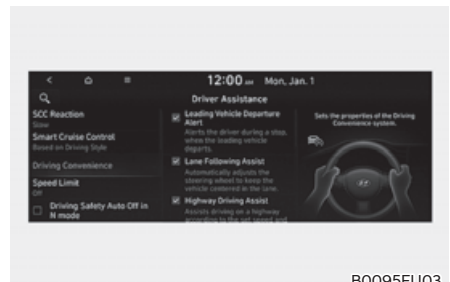

B0095EU03

The infotainment system may change after software updates. For more information, refer to the user's manual provided in the infotainment system and the quick reference guide.

# 5. Convenience Features

Accessing Your Vehicle.....	5-5
Using Remote Key .....	5-5
Using Smart Key .....	5-8
Immobilizer System .....	5-17
Hyundai Digital Key .....	5-18
Digital key (smartphone) .....	5-18
Digital key (Card key) .....	5-23
Used Vehicle/Digital Key Maintenance .....	5-28
Limitations of the System .....	5-28
Door Locks.....	5-29
Operating Door Locks From Outside the Vehicle .....	5-29
Operating Door Locks From Inside the Vehicle.....	5-32
Automatic Door Lock and Unlock Features.....	5-34
Child-Protector Rear Door Locks .....	5-35
Electronic Child Safety Lock.....	5-36
Theft-Alarm System .....	5-38
Rear Occupant Alert (ROA) .....	5-39
System Setting.....	5-39
System Operation.....	5-39
System Precautions.....	5-40
Integrated Memory System.....	5-41
Storing Memory Positions .....	5-41
Recalling Memory Positions .....	5-42
Resetting the System .....	5-42
Seat Easy Access .....	5-43
Steering Wheel.....	5-44
MDPS (Motor Driven Power Steering) .....	5-44
Tilt/Telescopic Steering .....	5-45
Horn.....	5-46
Heated Steering Wheel .....	5-46
Mirrors .....	5-47
Inside Rearview Mirror .....	5-47
Side View Mirrors .....	5-57
Reverse Parking Aid .....	5-59
Digital Center Mirror .....	5-60
System component .....	5-61
How to change the mode.....	5-61

- Windows ..... 5-66
  - Power Windows..... 5-67
- Panoramic Sunroof ..... 5-71
  - Power Sunshade..... 5-71
  - Tilt Open/Close..... 5-72
  - Slide Open/Close ..... 5-72
  - Automatic Reversal ..... 5-73
  - Resetting the Sunroof ..... 5-74
  - Sunroof Open Warning ..... 5-75
- Dual Sunroof ..... 5-76
- Hood ..... 5-82
  - Opening the Hood..... 5-82
  - Closing the Hood..... 5-82
- Liftgate..... 5-83
  - Opening the Liftgate ..... 5-83
  - Closing the Liftgate..... 5-83
  - Emergency Liftgate Safety Release ..... 5-84
- Power Liftgate ..... 5-85
  - Power Liftgate Operating Conditions ..... 5-85
  - Operating the Power Liftgate ..... 5-87
  - Setting the Power Liftgate ..... 5-88
  - Resetting the Power Liftgate..... 5-89
  - Emergency Liftgate Safety Release ..... 5-90
- Smart Liftgate ..... 5-90
  - Using Smart Liftgate ..... 5-91
  - Deactivating Smart Liftgate ..... 5-92
  - Detecting Area..... 5-92
- Fuel Filler Door ..... 5-93
  - Opening the Fuel Filler Door ..... 5-93
  - Closing the Fuel Filler Door ..... 5-93
- Head-Up Display (HUD)..... 5-95
  - Head-Up Display Settings ..... 5-95
  - Head-Up Display Information ..... 5-96
  - Precautions While Using the Head-Up Display..... 5-96

# 5. Convenient Features

Exterior Lights .....	5-98
Lighting Control.....	5-98
High Beam Operation .....	5-99
Turn Signals and Lane Change Signals .....	5-100
Battery Saver Function .....	5-101
Headlight Delay Function .....	5-101
High Beam Assist (HBA) .....	5-102
High Beam Assist Settings.....	5-102
High Beam Assist Operation.....	5-103
High Beam Assist Malfunction and Limitations .....	5-104
Interior Lights .....	5-105
Interior Lamp AUTO Off .....	5-105
Front Lamps.....	5-105
Rear Lamps .....	5-106
Vanity Mirror Lamp.....	5-106
Glove Box Lamp .....	5-106
Door Courtesy Lamp .....	5-107
Luggage Compartment Lamp .....	5-107
Puddle Lamp.....	5-107
Welcome System.....	5-108
Wipers and Washers .....	5-110
Front Windshield Wipers .....	5-110
Front Windshield Washers.....	5-111
Rear Window Wiper and Washer .....	5-113
Manual Climate Control System .....	5-114
Heating and Air Conditioning.....	5-115
Rear climate control.....	5-120
System Operation.....	5-124
System Maintenance .....	5-126
Automatic Climate Control System .....	5-128
Automatic Temperature Control Mode.....	5-129
Manual Temperature Control Mode.....	5-130
Rear climate control.....	5-137
System Operation.....	5-141
System Maintenance .....	5-142
Windshield Defrosting and Defogging .....	5-145
Rear Window Defroster.....	5-149

Climate Control Additional Features .....	5-150
Auto Defogging System .....	5-150
Auto Dehumidify .....	5-151
Recirculating Air When Washer Fluid Is Used .....	5-151
Sunroof Inside Air Recirculation.....	5-152
Scheduled Ventilation Control .....	5-152
Storage Compartment.....	5-153
Center Console Storage.....	5-153
Glove Box .....	5-153
Interior Features.....	5-154
Cup Holder.....	5-154
Conversation mirror .....	5-156
Sunvisor .....	5-156
Power Outlet.....	5-157
USB Charger .....	5-158
AC Inverter .....	5-159
Wireless Smart Phone Charging System .....	5-161
Clock .....	5-163
Coat Hook.....	5-164
Floor Mat Anchor(s).....	5-164
Rear Side Window Sunshades.....	5-165
Cargo Net Holder .....	5-166
Cargo Security Screen .....	5-166
Exterior Features .....	5-169
Roof Side Rails.....	5-169
Infotainment System .....	5-170
USB Port.....	5-170
Antenna.....	5-170
Steering Wheel Remote Controls .....	5-170
Infotainment System.....	5-171
Voice Recognition .....	5-171
Bluetooth® Wireless Technology .....	5-172

## ACCESSING YOUR VEHICLE

### Using Remote Key (if equipped)



Your HYUNDAI uses a remote key, which you can use to lock or unlock the driver and passenger doors or the liftgate.

- ① Door Lock
- ② Door Unlocks
- ③ Liftgate Unlock (if equipped)
- ④ Panic

### Locking

To lock :

- ① Close all doors, engine hood and liftgate.
- ② Press the Door Lock button ① on the remote key.
- ③ The doors will lock. The hazard warning lights will blink.
- ④ Make sure the doors are locked by checking the indicator light on the driver side door lock button.



### WARNING

**Do not leave the Remote key in your vehicle with children that are unattended or unsupervised.**

**Children could inadvertently press the Engine Start/Stop button or could operate the power windows or other vehicle controls or even cause the vehicle to move. This could result in serious injury or death.**

### Unlocking your vehicle

To unlock your vehicle :

- 1. Press the Door Unlock button ② on the remote key.
- 2. The driver's door will unlock. The hazard warning lights will blink two times.

### Two Press Unlock Feature

The priority for unlocking the driver door only, or unlocking all the doors with one press may be adjusted in the User Settings mode in the cluster LCD display.

The Two Press Unlock feature, when enabled, will require the user to press the door unlock button once for driver door only and twice for unlocking all the doors.

You can activate or deactivate the Two Press Unlock feature from the Settings menu in the infotainment system.

Select:

- Setup → Vehicle → Door → Two Press Unlock

The Two Press Unlock feature can also be enabled or disabled by pressing the door lock and unlock buttons simultaneously on the Key:

Press and hold both the Door Lock button and the Door Unlock button simultaneously until the hazard warning lights blink.

This will enable or disable the Two Press Unlock feature. Repeat this procedure to enable/disable the mode again.

### Information

**After unlocking the doors, the doors will automatically relock after 30 seconds unless a door is opened.**

#### ***Liftgate unlocking (if equipped)***

To unlock the liftgate :

1. Press and hold the Liftgate Unlock button ③ on the remote key for more than one second.
2. The hazard warning lights will blink two times and the liftgate will open.
3. Once the liftgate is opened and then closed, the liftgate will automatically re-lock after 30 seconds.

### Information

**The word “HOLD” is written on the button to inform you that you must press and hold the button for more than one second.**

#### ***Panic alarm***

The horn sounds and the hazard warning lights blink for about 30 seconds if this button ④ is pressed for more than 1 second. To stop the horn and lights, press any button on the transmitter.

### ***Start-up***

For detailed information refer to “Ignition switch” in chapter 6.

### **NOTICE**

**To prevent damaging the remote key:**

- **Keep the remote key away from liquids or any type of extreme heat. If water or liquid gets inside of the remote or if the remote is subjected to extreme heat, damage to the internal circuit may result. This would void the vehicle warranty.**
- **Avoid dropping or throwing the remote key.**
- **Protect the remote key from extreme temperatures.**

### **Using Mechanical Key (if equipped)**



If the remote key does not operate normally, you can lock or unlock the door by using the mechanical key.

To unfold the key, press the release button then the key will unfold automatically.

To fold the key, fold the key manually while pressing the release button.

#### **NOTICE**

**Do not fold the key without pressing the release button. This may damage the key.**

#### **Remote key precautions**

The remote key will not work if any of the following occur:

- The key is in the ignition switch.
- You exceed the operating distance limit (about 32 feet [10m]).
- The remote key battery is weak.
- Other vehicles or objects may be blocking the signal.
- The weather is extremely cold.
- The remote key is close to a radio transmitter such as a radio station or an airport which can interfere with normal operation of the remote key.

When the remote key does not work correctly, unlock and lock the door with the mechanical key. If you have a problem with the remote key, it is recommended that you contact an authorized HYUNDAI dealer.

If the remote key is in close proximity to your mobile phone, the signal could be blocked by your mobile phone's normal operational signals.

This is especially important when the phone is active such as making and receiving calls, text messaging, and/ or sending/receiving emails.

Avoid placing the remote key and your mobile phone in the same location and always try to maintain an adequate distance between the two devices.

#### **i Information**

**This device complies with Part 15 of the FCC rules.**

**Operation is subject to the following three conditions:**

1. **This device may not cause harmful interference.**
2. **This device must accept any interference received, including interference that may cause undesired operation.**
3. **Changes or modifications not expressly approved by the party responsible for compliance could void the user's authority to operate the device.**

#### **NOTICE**

**Keep the remote key away from electromagnetic materials that block electromagnetic waves to the key surface.**



### Replacing Battery



B0921EU04

If the remote key is not working properly, try replacing the battery with a new one.

Battery Type: CR2032

To replace the battery:

1. Insert a slim tool into the slot and gently pry open the cover.
2. Using a screw driver, remove the battery cover.
3. Remove the old battery and insert the new battery. Make sure the battery position is correct.
4. Reinstall the battery cover and key cover in the reverse order of removal.

If you suspect your remote key might have sustained some damage, or you feel your remote key is not working correctly contact an authorized HYUNDAI dealer.



### WARNING

**THIS PRODUCT CONTAINS A BUTTON BATTERY.**

**If swallowed, a lithium button battery can cause severe or fatal injuries within 2 hours. Keep batteries out of reach of children.**

**If you think batteries may have been swallowed or placed inside any part of the body, seek immediate medical attention.**

### Information



An inappropriately disposed battery can be harmful to the environment and human health. Dispose of the battery according to your local law(s) and regulation.

### Using Smart Key (if equipped)

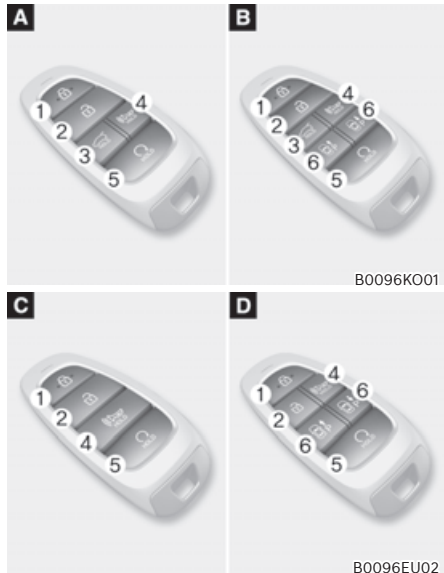

B0096K001

B0096EU02

Your HYUNDAI maybe equipped with a smart key, which you can use to lock or unlock the doors and liftgate, and start the engine while just having the key in your possession.

- ① Door lock
- ② Door unlock
- ③ Liftgate Unlock (Manual liftgate)  
Liftgate Open/Close (Power liftgate)
- ④ Panic
- ⑤ Remote start
- ⑥ Remote Smart parking Assist (Forward/Backward)

### Locking your vehicle (Button type)



To lock your vehicle using the door handle button or the Smart Key:

1. Make sure all doors, the hood and the liftgate are closed.
2. Make sure you have the smart key in your possession.
3. Press either the button on the door handle or the Door Lock button ① on the smart key. The chime will sound once and the hazard warning lights will blink.
4. Make sure the doors are locked by checking the position of the door lock button inside the vehicle.

Even though you press the outside door handle button, the doors will not lock and the chime will sound for three seconds if any of the following occur:

- The Smart Key is in the vehicle.
- The ignition switch is in ACC or ON position.
- Any door except the liftgate is open.

### Locking your vehicle (Touch sensor type)



1. Make sure that all doors are closed.
2. While having the Smart Key in your possession, touch the outer part of the door handle on or near the handle detent for about 1 second or until you hear the door locks actuate.
3. The doors will be locked. If the liftgate was open, then when the liftgate is closed it will be locked also.

The chime will sound once and the hazard warning lights will blink.

- The door handle button will only operate when the smart key is within 28~40 inches (0.7~1 m) from the outside door handle.
- Make sure the doors are locked by pulling the door handle. If you locked the door with the touch sensor on the door handle, the doors cannot be unlocked with the sensor within 3 seconds.

Note that if you press the outside door handle to lock the doors using the touch sensor, the doors will not lock under the following circumstances:

- The Smart Key is in the vehicle
- The Engine Start/Stop button is in the ACC or ON position
- Any of the doors are open (except for the liftgate)

If this occurs, then a chime will sound for about 3 seconds. Check the vehicle before attempting to lock the car again.



### CAUTION

**Before you leave your vehicle with the Smart Key, verify that your vehicle is locked. When using the touch sensor on the front door handle, listen to hear that the lock has actuated, and then pull the handle within 3 seconds to confirm the doors are locked.**

**(If it has been longer than 3 seconds, verify the doors are locked by pressing the lock button on the Smart Key. You will hear a single beep.)**



### WARNING

**Do not leave the Smart Key in your vehicle with children that are unattended or unsupervised.**

**Children could inadvertently press the Engine Start/Stop button or could operate the power windows or other vehicle controls or even cause the vehicle to move. This could result in serious injury or death.**

### Unlocking your vehicle (Button type)



1. Have the smart key with you.
2. Press the door handle button or press the Door Lock button ② on the smart key to unlock the doors. The chime sounds and hazard warning lights blink two times.

If you unlock the doors using the passenger side door handle, all the doors are unlocked. If you unlock the doors using the driver side door handle, either the driver's side door is unlocked or all the doors are unlocked depending on the setting for the Two Press Unlock feature.



### Information

- **Change the Driver Door unlock mode by referring to "Setting the Two Press Unlock feature".**
- **The door handle button or touch sensor only operates when the smart key is within 28-40 inches (0.7-1 m) from the outside door handle.**
- **If you do not open the door after unlocking within 30 seconds, it returns to the lock mode.**

### Unlocking your vehicle (Touch sensor type)

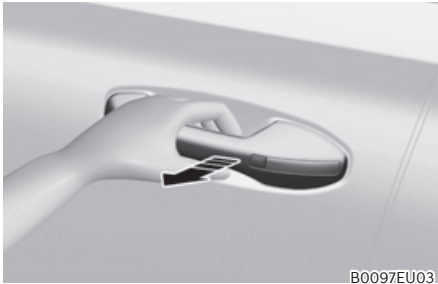

1. Have the smart key with you.
2. Press the Door Unlock button ② on the Smart Key or simply Grab the door handle inside portion to activate the unlock door touch sensor to unlock the doors. The chime sounds and hazard warning lights blink two times. If you unlock the doors using the passenger side door handle, all the doors are unlocked. If you unlock the doors using the driver side door handle, either the driver's side door is unlocked or all the doors are unlocked depending on the setting for the Two Press Unlock feature.

#### **i** Information

- **Change the Driver Door unlock mode by referring to User Settings.**
- **The door handle button or touch sensor only operates when the smart key is within 28-40 inches (0.7-1 m) from the outside door handle.**
- **If you do not open the door after unlocking within 30 seconds, it returns to the lock mode.**
- **If you unlock the door with the door handle, the doors cannot be locked with the touch sensor within 2 seconds.**

#### To prevent unintentional door lock or unlock:

Press the lock button on the smart key and immediately press the unlock button along with the lock button for more than 4 seconds. The hazard warning lights will blink four times. At this time, the doors will not lock or unlock even though the touch sensor is touched on the outside door handle.

To deactivate the function, press the door lock or unlock button on the smart key.

#### Setting the Two Press Unlock feature

You can activate or deactivate the Two Press Unlock feature from the Settings menu in the infotainment system.

Select:

- Setup → Vehicle → Door → Two Press Unlock

#### **i** Information

**During a car wash or rain, in order to minimize unintentional operation of the touch sensor, the touch sensor may become insensitive. This is not a malfunction.**

### **Opening the liftgate**

#### **Non-power liftgate**

To unlock and open the liftgate:

1. Make sure you have the smart key in your possession.
2. Press either the liftgate handle release switch on the vehicle for more than one second. The hazard warning lights will blink two times and the liftgate latch will unlock.
3. Once the liftgate is opened and then closed, the liftgate will automatically re-lock after 30 seconds.

#### **Information**

**The liftgate handle switch will only operate when the smart key is within 28 inches (0.7 m) from the liftgate handle.**

#### **Power liftgate**

To unlock and open the liftgate:

1. Make sure you have the smart key in your possession.
2. Press either the liftgate handle release switch on the vehicle or press and hold the Liftgate Unlock button  on the smart key for more than one second. The hazard warning lights will blink two times and the liftgate latch will open.
3. Once the liftgate is opened and then closed, the liftgate will automatically re-lock after 30 seconds.

#### **Information**

**The liftgate handle switch will only operate when the smart key is within 28 inches (0.7 m) from the liftgate handle.**

### **Remotely starting vehicle (if equipped)**

You can start the vehicle using the Remote Start button on the smart key.

To start the vehicle remotely:

1. Before you can use remote start your vehicle, the door lock button must be pressed. Press the door lock button on the Smart Key. You must be within about 32 feet (10m) from your vehicle.
2. Press and hold the remote start button on your Smart Key. You must press the button within 4 seconds from when you pressed the door lock button to activate the remote start.
3. The hazard warning lights will blink and the engine will start.
4. To turn off the remote start function, press the Remote Start button once.

## **i** Information

- **Laws in your country may restrict the use of remote start. You should check country regulations before using this remote starting system.**
- **The vehicle must be in P (Park) for the remote start function to start.**
- **The engine turns off if you get on the vehicle without a registered smart key.**
- **The engine turns off if you do not get on the vehicle within 10 minutes after remotely starting the vehicle.**
- **The Remote Start button may not operate if the smart key is not within 32 feet (10 m).**
- **The vehicle will not remotely start if the engine hood or liftgate is opened.**
- **Do not idle the engine for a long period.**
- **The Remote start function works the same as Blue Link remote start. For further caution information, refer to the separately supplied “Blue Link (Infotainment system) manual”.**

## **Remote Smart Parking Assist Feature (if equipped)**

Some models are equipped with Remote Smart Parking Assist Feature. With the Smart Key, the vehicle can be moved forward or backward remotely to enter or exit a tight parking space.

For more details, refer to “Remote Smart Parking Assist (RSPA)” section in chapter 7.

## **Panic alarm**

The horn sounds and the hazard warning lights blink for about 30 seconds if this button is pressed for more than 1 second. To stop the horn and lights, press any button on the transmitter.

### **Start-up (if equipped)**

Some models are equipped with a push button start instead of a key cylinder. You can leave your Smart Key in your pocket or purse when you start your vehicle.

For more details, refer to the “Engine Start/Stop Button” section in chapter 6.

### **i Information**

#### **Preventing the doors/liftgate from locking/unlocking**

- **Activating the feature**

With the engine off, press the lock button on the smart key and immediately press the unlock button along with the lock button for more than 4 seconds. When the feature is activated, the hazard warning lights will blink four times.

- **How the feature works**

When the feature is activated, the doors or liftgate will not lock or unlock even though the outside door handle button or liftgate handle release switch is pressed with the smart key in your possession. Also, Welcome System (if equipped) and Smart Liftgate (if equipped) will not operate even though you approach the vehicle with the smart key.

- **Deactivating the feature**

Press the door lock or unlock button on the smart key, the feature will deactivate.

### **i Information**

If the smart key is not moved for some time, the detection function for smart key operation will pause. Lift the smart key to activate the detection again.

### **NOTICE**

To prevent damaging the smart key:

- Keep the smart key in a cool, dry place to avoid damage or malfunction. Exposure to moisture or high temperature may cause the internal circuit of the smart key to malfunction which may not be covered under warranty.
- Avoid dropping or throwing the smart key.
- Protect the smart key from extreme temperatures.

### Using Mechanical Key

If the Smart Key does not operate normally, you can lock or unlock the driver's door by using the mechanical key.

To remove the mechanical key from the smart key:

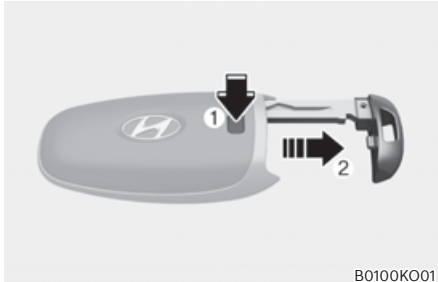

B0100K001

Press and hold the release button ① and remove the mechanical key ②. Insert the mechanical key into the key hole on the door.

To reinstall the mechanical key, put the key into the hole and push it until a click sound is heard.

### Key Cylinder (Driver Door)

A key cylinder is located on the driver side door handle hidden behind a plastic cover. Using the mechanical key, push and hold the key cylinder cover release button located on the underside of the door handle.

Use the mechanical key inserted into the release button slot to open the cover outward. Once the cover is off, the mechanical key can be inserted into the key cylinder to lock or unlock the vehicle.

To reinstall the mechanical key into the smart key, put the key into the smart key hole and push inward until a click sound is heard.

### Loss of a smart key

A maximum of two smart keys can be registered to a single vehicle. If you happen to lose your smart key, immediately take the vehicle and remaining key to your authorized HYUNDAI dealer or tow the vehicle, if necessary.

### Smart key precautions

The smart key may not work if any of the following occur:

- The smart key is close to a radio transmitter such as a radio station or an airport which can interfere with normal operation of the transmitter.
- The smart key is near a mobile two way radio system or a mobile phone.
- Another vehicle's smart key is being operated close to your vehicle.
- The vehicle battery is discharged.

If the smart key does not work correctly, open and close the door with the mechanical key. If you have a problem with the smart key, contact an authorized HYUNDAI dealer.

If the smart key is in close proximity to your mobile phone, the signal could be blocked by your mobile phone's normal operational signals. This is specifically relevant when the phone is active such as making and receiving calls, text messaging, and/or sending/receiving emails. When possible, avoid keeping the smart key and your mobile phone in the same location such as a pants or jacket pocket in order to avoid interference between the two devices.

### Information

**If the smart key is not moved for some time, the detection function for smart key operation will pause. Lift the smart key to activate the detection again. (if equipped)**



**NOTICE**

To prevent damaging the smart key:

- Keep the smart key in a cool, dry place to avoid damage or malfunction. Exposure to moisture or high temperature may cause the internal circuit of the smart key to malfunction which may not be covered under warranty.
- Avoid dropping or throwing the smart key.
- Protect the smart key from extreme temperatures.

**NOTICE**

- Keep the smart key away from electromagnetic materials that blocks electromagnetic waves to the key surface.
- Always have the smart key with you when leaving the vehicle. If the smart key is left near the vehicle, the vehicle battery may be discharged.

**i Information**

This device complies with Part 15 of the FCC rules.

Operation is subject to the following three conditions:

1. This device may not cause harmful interference.
2. This device must accept any interference received, including interference that may cause undesired operation.
3. Changes or modifications not expressly approved by the party responsible for compliance could void the user's authority to operate the device.

**Battery replacement**



If the Smart Key is not working properly, try replacing the battery with a new one.

Battery Type: CR2032

To replace the battery:

1. Remove the mechanical key.
2. Use a slim tool or utility blade to pry open the cover of the smart key. Use caution not to damage the smart key.
3. Remove the old battery and insert the new battery. Make sure the battery position is correct.
4. Reinstall the rear cover of the smart key.

If you suspect your smart key might have sustained some damage, or you feel your smart key is not working correctly, it is recommended that you contact an authorized HYUNDAI dealer.

**⚠ WARNING**

**THIS PRODUCT CONTAINS A BUTTON BATTERY.**

If swallowed, a lithium button battery can cause severe or fatal injuries within 2 hours. Keep batteries out of reach of children.

If you think batteries may have been swallowed or placed inside any part of the body, seek immediate medical attention.

### Information



An inappropriately disposed battery can be harmful to the environment and human health. Dispose of the battery according to your local law(s) or regulations.

### Immobilizer System

The immobilizer system helps protect your vehicle from theft. If an improperly coded key (or other device) is used, the engine's fuel system is disabled.

When the ignition switch is turned to ON position (or the Engine Start/Stop button is pressed to the ON position), the immobilizer system indicator should come on briefly, then go off. If the indicator starts to blink, the system does not recognize the coding of the key.

Turn the ignition switch to the Lock position, then turn the ignition switch to the ON position again. (For remote key)

Press the Engine Start/Stop button to the OFF position, then press the Engine Start/Stop button to the ON position again. (For smart key)

The system may not recognize your key's coding if another immobilizer key or other metal object (for example, key chain) is near the key. The engine may not start because the metal may interrupt the transponder signal from transmitting normally.

If the system repeatedly does not recognize the coding of the key, it is recommended that you contact your HYUNDAI dealer.

Do not attempt to alter this system or add other devices to it. Electrical problems could result that may make your vehicle inoperable.

### WARNING

In order to prevent theft of your vehicle, do not leave spare keys anywhere in your vehicle. Your immobilizer password is a customer unique password and should be kept confidential.

### **NOTICE**

The transponder in your key is an important part of the immobilizer system. It is designed to give years of trouble-free service, however you should avoid exposure to moisture, static electricity and rough handling. Immobilizer system malfunction could occur.

### Information

This device complies with Part 15 of the FCC rules. Operation is subject to the following three conditions:

1. This device may not cause harmful interference, and
2. This device must accept any interference received, including interference that may cause undesired operation.
3. Changes or modifications not expressly approved by the party responsible for compliance could void the user's authority to operate the device.

## HYUNDAI DIGITAL KEY (IF EQUIPPED)

Hyundai digital key provides convenience to the driver, which the driver can use to lock or unlock the driver and passenger doors or the liftgate and turn of the vehicle.

### Digital key (smartphone)

#### **i** Information

- Hyundai digital keys are only available on smartphone that support digital key functions, and digital key functions of smartphones are provide by smartphone manufacturers.
- Available smartphone models can be found on our website (<https://owners.hyundai.com/us/en/resources/in-vehicle-navigation/introducing-all-new-digital-key.html>).
- Depending on the availability of service on the vehicle, some functions may not operated.

#### **Setting your smart phone**

To use the digital key (Smart phone), download the Blue Link App and sign up Hyundai account and service.

For more information about Blue Link, refer to the infotainment system guide.

#### **Registering your digital key (smart phone)**

1. Turn on the vehicle with a smart key. Have your smart key with you in the vehicle.



2. From the infotainment system Settings menu, select 'Setup → Vehicle → Digital Key → Smartphone Key → My Smartphone Key'.
3. After selecting 'Digital Key → Set Up Digital Key' from the My Hyundai App in the smart phone, register the digital key according to the guidance in the smart phone screen.
  - The NFC Antenna position on Samsung device can be found in the following path: Settings → Connections → NFC and contactless payments.



- The NFC Antenna position on Apple iPhone is located at the top of the rear (A) and Apple WATCH is located at the center of the screen (B).
  - Place your smart phone on the vehicle authentication pad (wireless charging pad) with the screen facing up. (In case of Apple WATCH, need to touch the pad with WATCH screen face).
  - Ensure that the NFC Antenna position on the smart phone is in contact with the vehicle authentication pad (wireless charging pad).
  - The location of the NFC Antenna on the smart phone may vary by phone model, so please contact the smartphone manufacturer for details.
  - NFC communication may not work for some smart phones depending on the internal structure of the smart phone. Move the smart phone to the left or right of the indoor authentication pad (wireless charging pad) to operate.
4. Press the 'Save' button from the infotainment system screen. The saving process begins automatically.
- When the digital key (smart phone) is saved, a message appears on the infotainment system screen.

## **i** Information

- If you want to register a digital key (smart phone) again, refer to 'How to Delete Digital Key (Smart Phone)' and delete the digital key (smart phone) before re-registering.
- During the digital key saving process, the process will cancel when:
  - The smart phone is removed from the vehicle authentication pad (wireless charging pad)
  - The infotainment system screen is changed
  - The vehicle is turned off
  - The gear is shifted
- The registering process does not start if a smart key is not in the vehicle.
- Some smart phones may not start the registering process depending on the internal structure. Move the smart phone to the left or right on the vehicle authentication pad (wireless charger pad) and try registering the smart phone.

### **Using the digital key (smart phone)**

The driver can lock or unlock the door by placing the smart phone on the outside door handle, and the vehicle can be started by placing the smart phone on the vehicle authentication pad (wireless charging pad).

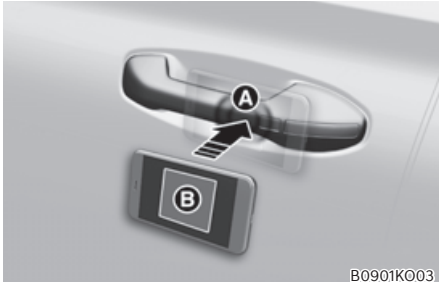

Ⓐ: Door handle authentication pad,

Ⓑ: NFC Antenna

- The NFC Antenna position on Samsung device can be found in the following path: Settings → Connections → NFC and contactless payments.



B0901K007

- The NFC Antenna position on Apple iPhone is located at the top of the rear Ⓐ and Apple WATCH is located at the center of the screen Ⓑ.
- Touch the Door handle NFC Antenna position with the back of your smart phone. (In case of Apple WATCH, need to touch the pad with WATCH screen face).
- The location of the NFC Antenna on the smart phone may vary by phone model, so please contact the smartphone manufacturer for details.

### Locking/Unlocking the doors

- If the driver places the digital key (smart phone) NFC antenna to the driver's or passenger's door handle authentication pad  for more than 2 seconds, the door will lock or unlock.
- If the Two Press Unlock feature is set, only the driver's door unlock when the digital key (smart phone) is placed on the driver's door handle authentication pad. Hold the digital key (smart phone) near the driver's door handle authentication pad once more within 4 seconds to unlock all doors.
- After unlocking the doors, the doors will automatically re-lock after 30 seconds unless a door is opened.
- If the smart phone digital key does not operate, try again after moving the smart phone away from the door handle authentication pad (more than 4 in. (0.1 m)).

### Information

You cannot lock your vehicle using the digital key (smart phone) if any of the following occurs:

- The smart key is in the vehicle.
- The Start/Stop button is in the ACC or ON position.
- Any of the doors, hood, or liftgate are open.

### Starting the vehicle

After placing your registered digital key (smart phone) on the vehicle authentication pad (wireless charging pad), depress the brake pedal and press the Start/ Stop button.

After starting the vehicle, the digital key (smart phone ) may be removed from the vehicle authentication pad (wireless charging pad).

For more details on the basic way to start the vehicle, refer to the "Start/Stop Button" section in chapter 6.

### Information

**If a shared digital key (smart phone) is used for the first time, the activating time may take longer.**

- **Place the shared digital key (smart phone) on the door handle authentication pad until the vehicle door lock/unlock activates.**
- **If a shared digital key (smart phone) is first used on the vehicle authentication pad (wireless charger pad), the initial start of the vehicle may fail.**
- **If the door lock/unlock is activated once with the shared digital key (smart phone) or the vehicle is started with the digital key (smart phone) on the vehicle authentication pad, the digital key (smart phone) will be registered in the vehicle.**

### WARNING

The vehicle can be started when the registered smart phone is placed on the vehicle authentication pad (wireless charging pad). Therefore, do not leave unsupervised children or people who are not aware of the system since it can result in serious injury or death. In addition, always have the registered smart phone with you to prevent vehicle theft when leaving the vehicle.

### **Deleting your digital key (smart phone)**

Turn on the vehicle with a smart key. Have your smart key with you in the vehicle.

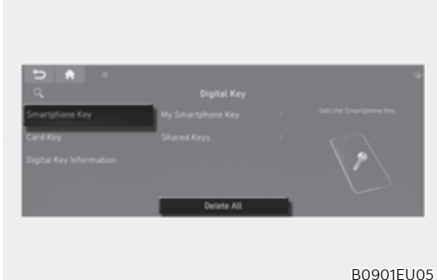

B0901EU05

### **Deleting all registered digital key (smart phone)**

To delete all the registered digital key (smart phone), from the Settings menu select 'Setup → Vehicle → Digital Key → Smartphone Key → Delete All' in the infotainment system.

- The 'Delete All' button is disabled if there is no registered digital key (smart key).

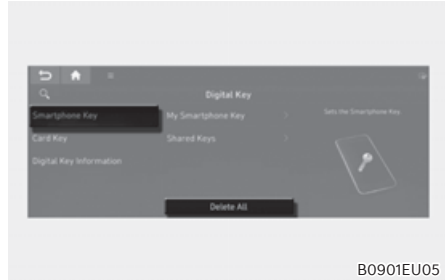

B0901EU05

### **Deleting my registered digital key (smart phone)**

To delete only my registered digital key (smart phone), from the Settings menu select 'Setup → Vehicle → Digital Key → Smartphone Key → My Smartphone Key → Delete' in the infotainment system.

- If a shared digital key (smart phone) is registered, it cannot be deleted.
- A new smart phone can be registered after deleting the existing digital key (smart phone) from 'My Smartphone Key' menu.

### **i Information**

- **If the registered digital key (smart key) is deleted, the digital key saved in the smart phone will also be deleted.**
- **If the digital key is deleted from the smart phone, the digital key (smart phone) registered in the vehicle will also be deleted.**
- **The shared digital key registered in the vehicle cannot be deleted individually.**
- **Even though the Blue Link® App is deleted from the smart phone, the digital key saved in the smart phone will not be deleted.**
- **Management of the digital key saved in the smart phone is available from the Digital Key App provided by the smart phone manufacturer.**

## Digital key (Card key)

### How to register Digital Key (Card Key)

To use the card key as a digital key, follow the following procedure.

1. Have both of your smart keys with you in the vehicle.



B0902EU01

2. Select 'Setup → Vehicle → Digital Key → Card Key' from the Settings menu, and check whether 'Enabled Card Key' is selected in the infotainment system.



B0901KO02

3. Place your card key on the vehicle authentication pad (wireless charging pad) while the vehicle is on.
4. Register your card key by selecting 'Setup → Vehicle → Digital Key → Card Key → Save' from the Settings menu in the infotainment system.

### **i** Information

- **When there is a digital key (card key) already registered in the vehicle, a new digital key (card key) cannot be registered. Re-register a new digital key (card key) after deleting the exiting digital key (card key).**
- **To register a digital key (card key), both of your smart keys must be in the vehicle.**
- **A registered digital key (card key) cannot be registered in other vehicles.**



### Using the digital key (card key)

The driver can lock or unlock the door by placing the card key on the outside door handle, and the vehicle can be started by placing the card key on the vehicle authentication pad (wireless charging pad).

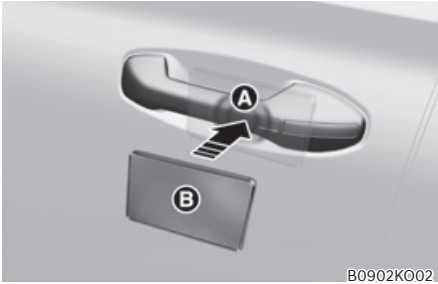

Ⓐ: Door handle authentication pad,

Ⓑ: Card key NFC Antenna

#### • Locking/Unlocking the doors

- If the driver places the digital key (Card key) to the driver's or passenger's door handle authentication pad Ⓐ for more than 2 seconds, the door will lock or unlock.
- If the Two Press Unlock feature is set, only the driver's door unlock when the digital key (Card key) is placed on the driver's door handle authentication pad. Hold the digital key (Card key) near the driver's door handle authentication pad once more within 4 seconds to unlock all doors.
- After unlocking the doors, the doors will automatically re-lock after 30 seconds unless a door is opened.

### Information

**You cannot lock your vehicle using the digital key (Card key) if any of the following occurs:**

- The smart key is in the vehicle.
- The Start/Stop button is in the ACC or ON position.
- Any of the doors, hood, or liftgate are open.

#### • Starting the vehicle

After placing your registered digital key (card key) on the vehicle authentication pad (wireless charging pad), depress the brake pedal and press the Engine Start/ Stop button.

For more details on the basic way to start the vehicle, refer to "Ignition Switch" or "Engine Start/Stop Button" section in chapter 6.

### WARNING

**The vehicle can be started when the registered card key is placed on the vehicle authentication pad (wireless charging pad). Therefore, do not leave unsupervised children or people who are not aware of the system since it can result in serious injury or death. In addition, always have the registered card key with you to prevent vehicle theft when leaving the vehicle.**

**NOTICE**

- The digital key (card key) may not work under the following conditions:
  - The digital key (card key) is not placed on the door handle authentication pad or vehicle authentication pad (wireless charging pad) correctly.
  - The digital key (card key) is near NFC-enabled cards such as credit cards or smart phones.  
If the digital key (card key) does not work, try again after moving the digital key (card key) away from the door handle authentication pad (more than 4 in. (0.1 m)).
- The digital key (card key) can be damaged by impacts. If the digital key (card key) is damaged, replace the digital key (card key) with a new one and register it again.
- Long-time exposure to high temperature may cause the digital key (card key) to malfunction. Be careful not to expose the digital key (card key) to direct sunlight or high temperature.

**Deleting your digital key (card key)**

1. Turn on the vehicle with a smart key. Have your smart key with you in the vehicle.



B0902EU03

2. From the infotainment system settings menu, select 'Setup → Vehicle → Digital Key → Card Key → Delete'.
  - The 'Delete' button is disabled if there is no digital key (card key) registered.

**Personalized profile and vehicle settings**

You can set the registered digital key (smart phone) profiles for Driver 1 and Driver 2. When you use the digital key (smart phone), the vehicle can be set to the user-defined personalized profile (includes items such as vehicle settings and audio preferences).

### Linking/Unlinking profile

#### How to link user profile

1. Select 'Setup → User Profile → Profile Settings → Link Digital Key (Smartphone)' from the Settings menu in the infotainment system.
2. Select 'Link' to connect the registered smart phone's digital key and the user's profile.
3. Follow the instructions according to the message on the infotainment system screen.

#### How to unlink user profile

Select 'Setup → User Profile → Profile Settings', and then deselect 'Link Digital Key (Smartphone)' from Settings menu in the infotainment system.

- Unlinking is possible only when user profile is linked.

### Information

- **User profile cannot be linked to both Driver 1 and Driver 2 that are connected to single smart phone. Personalization will operate with the recently linked user profile, and the previously linked user profile will be automatically canceled.**
- **User profile link works only when the digital key is registered to the vehicle.**
- **Digital key (Card key) cannot be linked with a user profile.**
- **If the user profile linked digital key in the smart phone is deleted, the digital key should be re-registered and personalized by linking the user profile again.**

### Vehicle personalization operation

- The personalization function linked with digital key works when the profile linked smart phone is placed on the outside door handle authentication pad to lock or unlock the doors.
- The profile set by the digital key can be changed manually from the infotainment system.
- The personalization function using the digital key can be operated after linking the digital key in the infotainment system profile menu.
- The personalization function works only when the vehicle is OFF or when the vehicle is started remotely. If the vehicle is not started remotely, the personalization function does not work with the digital key.

### Information

User profile operation according to door lock/unlock system is as follows:

Item	Personalization Operation
Initial value	Guest
Profile linked smart phone key	Linked profile
Profile unlinked smart phone key	Recently activated profile
NFC card key	
Smart key	

### ***Vehicle personalization with digital key***

The available personalization function in the vehicle is as follows:

System	Personalization Item	
Infotainment system vehicle settings	Lamp	Blink number of one-touch signal lamps
	Cluster	Information display on the cluster, Voice volume, Welcome sound
	Seat/Mirror	Seat position, Side view mirror position, Easy Access
		Intelligent driving posture assist (Smart IMS)
	Door	Automatic door lock/unlock, Two Press Unlock
	Head Up Display (HUD)	Position adjustment of image, Information display selection
Infotainment system	Navigation	Preferred volume of the navigation system, Recent destination
	User preset	My menu list settings, Radio preset
	Phone connectivity	Bluetooth preferential connect CarPlay/Android Auto On/Off
Air conditioning	Operating condition	Latest operation setup of the following functions:  Temperature, AUTO, air flow direction, air volume, air conditioner, air intake control, SYNC, Front windshield defroster, OFF



#### **CAUTION**

If you leave the digital key after locking or unlocking the doors or starting up the vehicle with the smart key, the doors can be locked by the central door lock. Please carry around the digital key all the time.



#### **Information**

The infotainment system may change after software updates. For more information, refer to the user's manual provided in the infotainment system and the quick reference guide.

### Used Vehicle/Digital Key Maintenance

#### ***Purchasing used vehicle***

If any of the digital key devices (smart phone key, card key) are registered in the vehicle, the 'Digital key registered' message appears once on the instrument cluster when the ignition switch is in the ON position after unlocking the doors. When purchasing a used vehicle, be sure to check the message and delete the smart phone key and card key registered by the previous user and inform the purchase of a used vehicle through Hyundai Customer Care Center.

If the card key comes with the vehicle, check whether it operates properly.

#### ***Digital Key Maintenance***

If you need to have your Digital Key System repaired or replaced, the registered smartphone key or card key.

### Limitations of the System

- Hyundai digital key may not operate if any of the following occurs:
  - The smart phone battery or the vehicle battery is discharged
  - NFC is turned off in the smart phone settings
  - A credit card is near your smart phone, or a metal or thick smart phone case is used
  - The card key is near other cards, or used in a wallet or card holder
  - There is electronic interference by other vehicles, objects, etc.
- The vehicle may not be controlled by the smart phone if any of the following occurs:
  - The basic necessary functions of the smart phone are operating (general call, urgent call, audio, etc.)
  - Using a wireless earphone (general call, urgent call, audio, etc.)

## DOOR LOCKS

### Operating Door Locks From Outside the Vehicle

#### Mechanical key

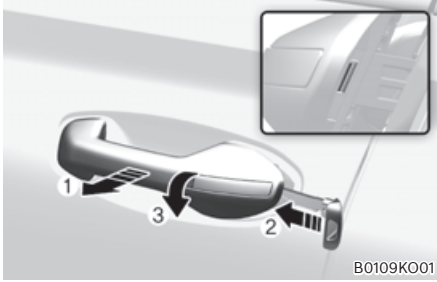

B0109KO01



B0109KO02

(A): Lock, (B): Unlock

First, pull the outside door handle ① and push the hook ② located inside of outside door handle by using the mechanical key. And remove the cover ③ and lower the cover downward not to be damaged.

#### NOTICE

Be careful not to damage the cover while removing it or misplace it after removing it.

After removing the cover, turn the key toward the front of the vehicle to unlock and toward the rear of the vehicle to lock.

If you lock the driver's door with a mechanical key, the driver's door will lock. If you unlock the driver's door with a mechanical key, you can open and close the driver's door only.

Once the doors are unlocked, they may be opened by pulling the door handle. When closing the door, push the door by hand. Make sure that doors are closed securely.

#### NOTICE

Do not apply excessive force on the door and door handle. It may damage the door and door handle.

#### **i** Information

- Be careful when locking the door by mechanical key operation, only the driver's door can be locked/unlocked.
- When removing the cover, be careful not to lose cover and any scratches.
- When the key cover freezes and does not open, lightly tap or indirectly warm (hand temperature, etc.) it.
- Do not apply excessive force to the door and door handle. It may be damaged.
- When the keyhole freezes and does not open, lightly tap or indirectly warm (for example, hand temperature) the keyhole.

### Remote key



B0115EU06

To lock the doors, press the Door Lock button ① on the remote key.

Press the Door Unlock button ② on the remote key, the driver's door will unlock. If you press the Door Unlock button on the remote key again within four seconds, then all the doors will unlock.

When closing the door, push the door by hand. Make sure that doors are closed securely.

### Smart key

#### Button type



B0097KO01

To lock the doors, press the button on the outside door handle while carrying the smart key with you or press the door lock button on the smart key.

To unlock the doors, press the button on the outside door handle while carrying the smart key with you or press the door unlock button on the smart key.

Once the doors are unlocked, they may be opened by pulling the door handle. When closing the door, push the door by hand. Make sure that doors are closed securely.

### Touch type



### Lock

Touch the touch sensor on the front outside door handle (the engraved part) while carrying the Smart Key with you or press the Door Lock button on the Smart Key, all doors will lock.

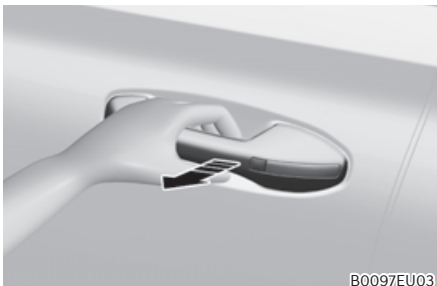

### Unlock

Put your hand in the front outside door handle while carrying the Smart Key with you or press the Door Unlock button on the Smart Key, all doors will unlock.

Once the doors are unlocked, they may be opened by pulling the door handle.

When closing the door, push the door by hand. Make sure that doors are closed securely.

For more details, refer to “Smart Key” in the previous pages.

### **i** Information

- During a car wash or rain, in order to minimize unintentional operation of the touch sensor, the touch sensor may become insensitive. This is not a malfunction.
- In cold and wet climates, door lock and door mechanisms may not work properly due to freezing conditions.
- If the door is locked/unlocked multiple times in rapid succession with either the vehicle key or door lock switch, the system may stop operating temporarily in order to protect the circuit and prevent damage to system components.



## Operating Door Locks From Inside the Vehicle

*With the door handle*

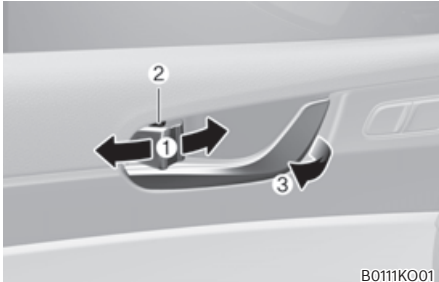

- To unlock a door, push the door lock button ① to the “Unlock” position. The red mark ② on the door lock button will be visible.
- To lock a door, push the door lock button ① to the “Lock” position. If the door is locked properly, the red mark ② on the door lock button will not be visible.
- To open a door, pull the door handle ③ outward.
- If the inner door handle of either the driver door or passenger door is pulled when the door lock button is in the lock position, the button is unlocked and the door will open.
- For Key Start Vehicles (with Remote Key)  
The front doors cannot be locked if the remote key is in the ignition switch and either of the front doors are open.
- For Push Button Start Vehicles (with Smart Key)  
The doors cannot be locked if the smart key is inside the vehicle and any of the doors are open.

### **i** Information

If a power door lock ever fails to function while you are in the vehicle try one or more of the following techniques to exit:

- Operate the door unlock feature repeatedly (both electronic and manual) while simultaneously pulling on the door handle.
- Operate the other door locks and handles, front and rear.
- Lower a front window and use the mechanical key to unlock the door from outside.

### **i** Information

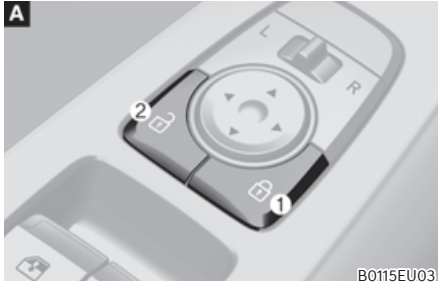

**When the vehicle’s battery run out and you leave the vehicle, make sure all the doors are locked. You can lock the driver’s door with a key and the rest of the doors with the lock button above the door inside handle.**

### With the central door lock switch



(A): Driver's door, (B): Front passenger's door

### Driver and passenger door

The driver and passenger side door armrest is equipped with a central door lock switch. The lock switch is indicated by a  symbol. The unlock switch is indicated by a  symbol.

- When the lock switch ① is pressed (door indicator light ON), all the vehicle doors will lock.
  - For Key Start Vehicles (with Remote Key)
 

If the key is in the ignition switch and any door is opened, the doors will not lock even though the lock button ① is pressed.
  - For Push Button Start Vehicles (with Smart Key)
 

If the smart key is in the vehicle and any door is open, the doors will not lock even though the lock button ① is pressed.
- When the unlock switch ② is pressed, all the vehicle doors will unlock.

### In case of an emergency



In case of emergency such as when the battery is discharged, the only way to lock the door(s) is with the mechanical key from the outside key hole.

Doors without an outside key hole can be locked as follows:

1. Open the door.
2. Insert the key into the emergency door lock hole and turn the key to the lock position.
3. Close the door securely.

### Information

**If the electrical power door lock switch does not operate (for example, dead car battery) and the liftgate is closed, you will not be able to open the liftgate until power is restored.**

### WARNING

- **The doors should always be fully closed and locked while the vehicle is in motion. If the doors are unlocked, the risk of being thrown from the vehicle in a crash is increased.**
- **Do not pull the inner door handle of the driver's or passenger's door while the vehicle is moving.**



## WARNING

Do not leave children or animals unattended in your vehicle. An enclosed vehicle can become extremely hot, causing death or serious injury to unattended children or animals who cannot escape the vehicle. Children might operate features of the vehicle that could injure them, or they could encounter other harm, possibly from someone gaining entry to the vehicle.



## WARNING

Always secure your vehicle.

Leaving your vehicle unlocked increases the potential risk to you or others from someone hiding in your vehicle.

To secure your vehicle, while depressing the brake, shift the gear to the P (Park) position, engage the parking brake, and press the Engine Start/Stop button to the OFF position, close all windows, lock all doors, and always take the key with you.



## CAUTION

Opening a door when something is approaching may cause damage or injury. Be careful when opening doors and watch for vehicles, motorcycles, bicycles or pedestrians approaching the vehicle in the path of the door.



## WARNING

If you stay in the vehicle for a long time while the weather is very hot or cold, there are risks of injuries or danger to life. Do not lock the vehicle from the outside when someone is in the vehicle.

## Automatic Door Lock and Unlock Features (if equipped)

Your vehicle is equipped with features that will automatically lock or unlock your vehicle based on settings you select in the infotainment system.

### ***Auto LOCK Enable on speed***

When this feature is set, all the doors will be locked automatically when the vehicle exceeds 9 mph (15 km/h).

### ***Auto LOCK Enable on shift***

When this feature is set, all the doors will be locked automatically when the vehicle is shifted out of P (Park) while the engine is running.

### ***Auto UNLOCK On Shift to P***

When this feature is set, all the doors will be unlocked automatically when the vehicle is shifted back into P (Park) while the engine is running.

### **Auto UNLOCK On key out (if equipped with remote key)**

When this feature is set, all the doors will be unlocked automatically when the ignition key is removed from the key ignition switch.

### **Auto UNLOCK Vehicle off (if equipped with smart key)**

When this feature is set, all the doors will be unlocked automatically when the vehicle is turned off.

### **Additional unlock safety feature air bag deployment**

As an additional safety feature, all doors will be automatically unlocked when an impact causes the air bags to deploy.

## **i Information**

**The infotainment system may change after software updates. For more information, refer to the user's manual provided in the infotainment system and the quick reference guide.**

### **Child-Protector Rear Door Locks (if equipped)**



The child safety lock is provided to help prevent children seated in the rear from accidentally opening the rear doors. The rear door safety locks should be used whenever children are in the vehicle.

The child safety lock is located on the edge of each rear door. When the child safety lock is in the lock position, the rear door will not open if the inner door handle is pulled.

To lock the child safety lock, insert a small flat blade tool (like a screwdriver or similar) ① into the slot and turn it to the lock position as shown.

To allow a rear door to be opened from inside the vehicle, unlock the child safety lock.

## **⚠ WARNING**

**If children accidentally open the rear doors while the vehicle is in motion, they could fall out of the vehicle. The rear door safety locks should always be used whenever children are in the vehicle.**

## Electronic Child Safety Lock (if equipped)



When the electronic child safety lock button is pressed and the indicator light on the button illuminates, the rear doors cannot be opened from inside the vehicle.

- The rear door window cannot be opened or closed while the electronic child safety lock button is in the LOCK position (indicator light ON).  
For more details, refer to “Windows” section in this chapter.
- Electronic child safety lock does not automatically turn on unless the driver presses the electronic child safety lock button.

- If 3 minutes passes after the ignition switch or Engine Start/Stop button is pressed to the LOCK/OFF or ACC, the indicator on the button turns off, and the driver cannot turn off electronic child safety lock by pressing the button. To turn off the function, press the Engine Start/Stop button to the ON position, and then press the electronic child safety lock button.
- If the power is supplied again after removing the battery or battery is discharged while the electronic child safety lock button is in the LOCK position, press the button once more to match the state of the indicator on the electronic child safety lock button and actual status of the electronic child safety lock function.
- If the airbag is activated while the electronic child safety lock button is in the LOCK position (indicator light ON), the rear doors will unlock automatically.
- Vehicles equipped with the electronic child safety lock feature is not provided with a manual child safety lock.

### **WARNING**

**If children accidentally opens the rear door while the vehicle is in motion, they could fall out of the vehicle. Electronic child safety lock should always be used whenever children are in the vehicle.**

**NOTICE****Child safety lock failure**

**If the Electronic child safety lock system is not operated when pushing the Electronic child safety lock switch, the message is displayed and the alarm will sound.**

**If this occurs, have the vehicle inspected by an authorized HYUNDAI dealer.**

***Safe Exit Assist (if equipped with electronic child safety lock)***

Safe Exit Assist helps prevent the rear occupant from opening the rear door. When an approaching vehicle from the rear area is detected after the vehicle stops, the rear doors will not unlock even when the driver tries to unlock the rear doors using the electronic child safety lock button.

For more details, refer to “Safe Exit Assist (SEA)” section in chapter 7.

## THEFT-ALARM SYSTEM

This system helps to protect your vehicle and valuables. The horn will sound and the hazard warning lights will blink continuously if any of the following occur:

- A door is opened without using the smart key.
- The liftgate is opened without using the smart key.
- The engine hood is opened.

The alarm continues for 30 seconds, then the system resets. To turn off the alarm, unlock the doors with the smart key.

The Theft Alarm System automatically sets 30 seconds after you lock the doors and the liftgate. For the system to activate, you must lock the doors and the liftgate from outside the vehicle with the smart key or by touching the touch sensor on the outside of the door handle with the smart key in your possession.

The hazard warning lights will blink and the chime will sound once to indicate the system is armed.

Once the security system is set, opening any door, the liftgate, or the hood without using the smart key will cause the alarm to activate.

The Theft Alarm System will not set if the hood, the liftgate, or any door is not fully closed. If the system will not set, check the hood, the liftgate, or the doors are fully closed.

Do not attempt to alter this system or add other devices to it.

### Information

- **Do not lock the doors until all passengers have left the vehicle. If the remaining passenger leaves the vehicle when the system is armed, the alarm will be activated.**
- **If the vehicle is not disarmed with the smart key, open the doors by using the mechanical key and place the ignition switch in the ON position (for remote key) or start the engine (for smart key) by directly pressing the ignition switch with the smart key.**
- **If the system is disarmed by unlocking the vehicle, but neither a door or the liftgate is opened within 30 seconds, the doors will re-lock and the system will rearm automatically.**
- **It is not recommended to install any secondary aftermarket theft-alarm systems into the vehicle factory electrical system.**

## REAR OCCUPANT ALERT (ROA) (IF EQUIPPED)

Rear Occupant Alert is provided to help prevent the driver from leaving the vehicle with the rear passenger left in the vehicle.

### System Setting

To use Rear Occupant Alert, it must be enabled from the Settings menu in the infotainment system screen. Select:

- Setup → Vehicle → Convenience → Rear Occupant Alert



### Information

**The infotainment system may change after software updates. For more information, refer to the user's manual provided in the infotainment system and the quick reference guide.**

### System Operation

- First alert  
When you open the front door after opening and closing the rear door and turning off the engine, the 'Check rear seats' warning message appears on the cluster.
- Second alert (if equipped)  
After the first alert, the second alert operates when any movement is detected in the vehicle after the driver's door is closed and all the doors are locked. The horn will sound for approximately 25 seconds. If the system continues to detect a movement, the alert operates up to 8 times.  
Unlock the doors with the smart key to stop the alert.
- The system detects movement in the vehicle for 8 hours after the door is locked.
- The second alert is activated only after the prior activation of the first alert.



## System Precautions

- Make sure that all the windows are closed. If the window is open, the alert may operate by the sensor detecting an unintended movement (for example, wind or bugs).

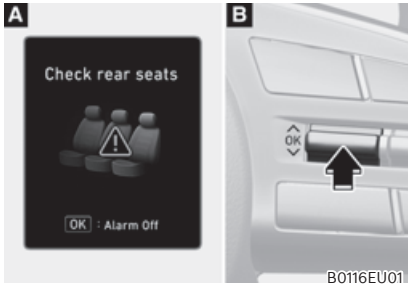

(A): Cluster, (B): Steering wheel

If you do not want to use Rear Occupant Alert, press the OK button on the steering wheel when the first alert is displayed on the cluster. Doing so will deactivate the second alert one time.

- An alert can occur if there is an impact on the roof.
- If boxes or objects are stacked in the vehicle, the system may not detect the boxes or objects. Or, the alert may operate if the boxes or objects fall off.
- The sensor may not operate normally if the sensor is obscured by foreign substances.
- The alert may operate if movement in the driver or passenger seat is detected.
- The alert may operate with the doors locked due to car wash or surrounding vibration or noise.
- If the vehicle is started remotely (if equipped with Remote Start), inside movement detection will stop.

## WARNING

Even if your vehicle is equipped with Rear Occupant Alert, always make sure to check the rear seat before you leave the vehicle.

Rear Occupant Alert may not operate when:

- Movement does not continue for a certain period of time or the movement is small.
- The rear passenger is covered with an object such as a blanket.
- Always be cautious of the passenger's safety as the detection function and second alert may not operate depending on the surrounding environment and certain conditions.

## INTEGRATED MEMORY SYSTEM (IF EQUIPPED)



B0122KO01

The IMS, or Integrated Memory System, for the driver's seat is provided to store and recall the following memory settings with a simple button operation.

- Driver's seat position
- Side view mirror position
- Head-Up Display (HUD) position (if equipped)



### WARNING

**Never attempt to operate the integrated memory system while the vehicle is moving.**

**This could result in loss of control, and an accident causing death, serious injury, or property damage.**

### **i** Information

- **If the battery is disconnected, the memory settings will be erased.**
- **If the Integrated Memory System does not operate normally, have the system inspected by an authorized HYUNDAI dealer.**

### Storing Memory Positions

1. Shift to P (Park) while the Ignition switch is in the ON position.
2. Adjust the driver's seat position, side view mirror position and head-up display height to the desired position.
3. Press the SET button. The system will beep once and notify you 'Press button to save settings' on the cluster LCD display.
4. Press one of the memory buttons (1 or 2) within 4 seconds. The system will beep twice when the memory has been successfully stored.
5. 'Driver 1 (or 2) settings saved' will appear on the cluster LCD display. The message appears only for the driver's seat position memory setting.

## Recalling Memory Positions

1. Shift to P (Park) while the Ignition switch is in the ON position.
2. Press the desired memory button (1 or 2). The system will beep once, and then the driver's seat position, side view mirror position and head-up display height will automatically adjust to the stored positions.
3. 'Driver 1 (or 2) settings applied' will appear on the cluster LCD display.

### Information

- **Note that while the memory settings are being recalled, if you press the SET button or the corresponding IMS memory button (1 or 2) for which the settings are being recalled, the IMS will temporarily deactivate. If you select the alternate IMS memory button (1 or 2), the IMS will activate according to the settings of the alternate button.**

**For example, if you press the SET button or the number 1 button with the number 1 setting in operation, the IMS will temporarily deactivate.**

**If you press the number 2 button, then the IMS memory settings according to number 2 will activate.**

- **If you adjust the driver's seat, side view mirror or head-up display while the IMS is recalling the stored positions, the memory settings will not be applied.**

## Resetting the System

Follow the below procedures to reset the Integrated Memory System (IMS) if it is not operating properly:

### ***Resetting integrated memory system***

1. Stop the vehicle and open the driver's door with the vehicle shifted to P (Park).
2. Adjust the driver's seat and seatback to the foremost position.
3. Press the SET button and push forward the driver's seat movement switch over 2 seconds simultaneously.

### ***While resetting integrated memory system***

1. Resetting starts with a notification sound.
2. The driver's seat and seatback is adjusted to the rearward position with the notification sound.
3. The driver's seat and seatback is re-adjusted to the default position (central position) with the notification sound.

However, in the following cases, the resetting procedure and the notification sound may stop.

- The memory button is pressed.
- The seat control switch is operated.
- The driving speed exceeds 2 mph (3 km/h).
- The driver's door is closed.

**NOTICE**

- **While integrated memory system is being reset, if the resetting and notification sound stops incompletely, restart the resetting procedure again.**
- **Make sure that there are no objects around the driver's seat in advance of resetting the integrated memory system.**
- **After resetting the integrated memory system, the adjustment for the driver seat must be stored again to recall the memory position.**

**Seat Easy Access (if equipped)**

Seat easy access will move the driver's seat and steering wheel automatically as follows:

- **Exiting the vehicle:**  
The driver's seat, steering wheel and seat bolster will move as follows when the ignition switch is in the LOCK/OFF position with the gear in P (Park) and the driver's door open.
  - Driver seat: Moves rearward depending on the distance selected from the Settings menu in the infotainment system.
  - Steering wheel: Moves upward

However, the driver's seat may not move rearward if there is not enough space between the driver's seat and the rear seats.

Also, on a regular basis, the steering wheel will also move forward to adjust its location by itself.

- **Entering the vehicle:**  
The driver's seat, steering wheel and seat bolster will move as follows when the ignition switch is placed to the ACC, ON or START position or while carrying the smart key, the driver's door is closed with the ignition switch is placed in the LOCK/OFF position.
  - Driver seat: Moves back to its original position.
  - Steering wheel: Moves back to its original position.
- You can set the Seat Easy Access function from the Settings menu in the infotainment system screen. Select:
  - Driver seat  
Setup → Vehicle → Seat → Seating Easy Access → Driver Seat Easy Access → Normal/Extended/Off
  - Steering wheel  
Setup → Vehicle → Seat → Seating Easy Access → Steering wheel easy access

** Information**

**The infotainment system may change after software updates. For more information, refer to the user's manual provided in the infotainment system and the quick reference guide.**

## STEERING WHEEL

### MDPS (Motor Driven Power Steering)

The system assists you with steering the vehicle. If the vehicle is turned off or if the power steering system becomes inoperative, you may still steer the vehicle, but it will require increased steering effort.

Should you notice any change in the effort required to steer during normal vehicle operation, have the system checked by an authorized HYUNDAI dealer.



#### CAUTION

If MDPS (Motor Driven Power Steering) does not operate normally, the  warning light and the message 'Check motor driven power steering' will illuminate on the instrument cluster. You may steer the vehicle, but it will require increased steering efforts. Take your vehicle to an authorized HYUNDAI dealer or to a service station and have the system checked as soon as possible.

### Information

The following symptoms may occur during normal vehicle operation:

- The steering effort may be high immediately after pressing the ignition switch or Engine Start/Stop button to the ON position.  
This happens as the system performs the MDPS system diagnostics. When the diagnostics are completed, the steering wheel effort will return to its normal condition.
- When the battery voltage is low, you might have to put more steering effort. However, it is a temporary condition so that it will return to normal condition after charging the battery.
- A click noise may be heard from the MDPS relay after the ignition switch or Engine Start/Stop button is in the ON or LOCK/OFF position.
- Motor noise may be heard when the vehicle is at a stop or at a low driving speed.
- When you operate the steering wheel in low temperatures, abnormal noise may occur. If the temperature rises, the noise will disappear. This is a normal condition.
- When an error is detected from MDPS, the steering effort assist function will not be activated in order to prevent fatal accidents. Instrument cluster warning lights may be on or the steering effort may be high. If these symptoms occur, drive the vehicle to a safe area as soon as it is safe to do so. Have the system checked by an authorized HYUNDAI dealer as soon as possible.

## Tilt/Telescopic Steering

When adjusting the steering wheel to a comfortable position, adjust the steering wheel so that it points toward your chest, not toward your face. Make sure you can see the instrument cluster warning lights and gauges. After adjusting, push the steering wheel both up and down to be certain it is locked in position.

Always adjust the position of the steering wheel before driving.



### WARNING

**NEVER** adjust the steering wheel while driving. This may cause loss of vehicle control resulting in an accident.

## Manual adjustment



To adjust the steering wheel angle and height:

1. Pull down the lock-release lever ①.
2. Adjust the steering wheel to the desired angle ② and distance forward/back ③.
3. Pull up the lock-release lever to lock the steering wheel in place.



### Information

Sometimes the lock release lever may not engage completely. This may occur when the gears of the locking mechanism do not completely mesh. If this occurs, pull down on the lock-release lever, readjust the steering wheel again, and then pull back up on the release lever to lock the steering wheel in place.

## Horn

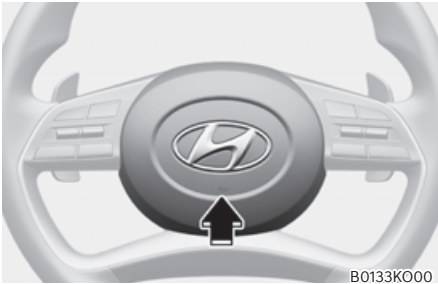

To sound the horn, press the area indicated by the horn symbol on your steering wheel (see illustration). The horn will operate only when this area is pressed.

### **NOTICE**

**Do not strike the horn severely or hit it with your fist. Do not press on the horn with a sharp-pointed object.**

## Heated Steering Wheel (if equipped)



When the Ignition switch or Engine Start/Stop button is in the ON position or when the engine is running, press the heated steering wheel button to warm the steering wheel. The indicator on the button will illuminate.

To turn the heated steering wheel off, press the button again. The indicator on the button will turn off.

- The heated steering wheel defaults to the OFF position whenever the Ignition switch or Engine Start/Stop button is in the ON position.

### **i** Information

**The heated steering wheel will turn off automatically approximately 30 minutes after the heated steering wheel is turned on.**

### **NOTICE**

**Do not install any cover or accessory on the steering wheel. The cover or accessory could cause damage to the heated steering wheel system.**

## MIRRORS

### Inside Rearview Mirror

Before driving your vehicle, check to see that your inside rearview mirror is properly positioned. Adjust the rearview mirror so that the view through the rear window is properly centered.



#### WARNING

Make sure your line of sight is not obstructed. Do not place objects in the rear seat, cargo area, or behind the rear headrests which could interfere with your vision through the rear window.



#### WARNING

To prevent serious injury during an accident or deployment of the air bag, do not modify the rearview mirror and do not install a wide mirror.



#### WARNING

NEVER adjust the mirror while driving. This may cause loss of vehicle control resulting in an accident.

#### NOTICE

When cleaning the mirror, use a paper towel or similar material dampened with glass cleaner. Do not spray glass cleaner directly on the mirror as this may cause the liquid cleaner to enter the mirror housing.

### Day/night rearview mirror (if equipped)

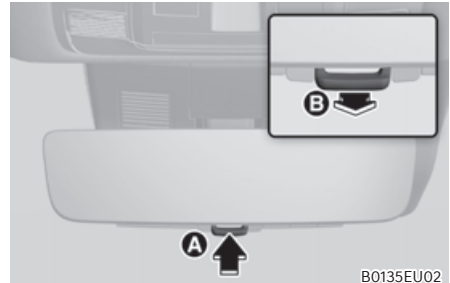

Ⓐ: Day, Ⓑ: Night

Make this adjustment before you start driving and while the day/night lever is in the day position.

Pull the day/night lever towards you to reduce glare from the headlights of the vehicles behind you during night driving.

Remember that you lose some rearview clarity in the night position.



### **Electrochromic Mirror (if equipped)**

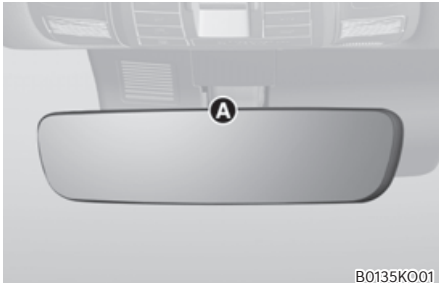

Ⓐ: indicator

The electric rearview mirror automatically controls the glare from the headlight of the vehicle behind you in nighttime or low light driving conditions.

When the engine is running, the glare is automatically controlled by the sensor mounted in the rearview mirror. The sensor detects the light level around the vehicle, and automatically adjusts to control the headlight glare from vehicles behind you.

Whenever the the transmission is shifted to R (Reverse), the mirror will automatically go to the brightest setting in order to improve the driver's view behind the vehicle.

### **Electrochromic mirror (ECM) with HomeLink® system (if equipped)**

Your vehicle may be equipped with a Gentex Automatic-Dimming Mirror with an Integrated HomeLink® Wireless Control System.

During nighttime driving, this feature will automatically detect and reduce rearview mirror glare. The HomeLink® Universal Transceiver allows you to activate your garage door(s), electric gate, home lighting, etc.



- ① HomeLink Channel 1
- ② HomeLink Channel 2
- ③ HomeLink Channel 3
- ④ Garage Door Opener Status Indicator: Closing or Closed
- ⑤ HomeLink Operation Indicator
- ⑥ Garage Door Opener Status Indicator: Opening or Opened
- ⑦ HomeLink User Interface Indicator

### Automatic-Dimming Night Vision Safety™ (NVS®) Mirror (if equipped)

The NVS® Mirror automatically helps reduce glare by monitoring light levels in the front and the rear of the vehicle. Any object that obstructs either light sensor will degrade the automatic dimming control feature.

**For more information regarding NVS® mirrors and other applications, please refer to the Gentex website:**

**[www.gentex.com](http://www.gentex.com)**

Your mirror will automatically dim upon detecting glare from the vehicles traveling behind you.

The mirror defaults to the ON position each time the vehicle is started.

### Integrated HomeLink® Wireless Control System

The HomeLink® Wireless Control System provides a convenient way to replace up to three hand held radio-frequency transmitters used to activate compatible devices such as gate operators, garage door openers, entry door locks, security systems, and home lighting.

### **NOTICE**

**HomeLink® operates while the ignition switch or Engine Start/Stop button is in the ACC or ON position for safety reasons. It is to prevent unintentional security problems from happening when the vehicle is parked outside the garage.**



### **WARNING**

**Before programming HomeLink® to a garage door opener or gate operator, make sure people and objects are out of the way of the device to prevent potential harm or damage. Do not use the HomeLink® with any garage door opener that lacks the safety stop and reverse features required by U.S. federal safety standards (this includes any garage door opener model manufactured before April 1, 1982). A garage door that cannot detect an object - signaling the door to stop and reverse - does not meet current U.S. federal safety standards. Using a garage door opener without these features increases the risk of serious injury or death.**

**For more information, contact HomeLink® at [www.homelink.com](http://www.homelink.com), or call Home-Link customer support at 1-800-355-3515.**

**It is also recommended that a new battery be replaced in the handheld transmitter of the device being trained to HomeLink® for quicker training and accurate transmission of the radio frequency.**

#### **1. Programming HomeLink®**

The following steps show how to program HomeLink. If you have any questions or are having difficulty programming your HomeLink buttons, refer to the HomeLink website or call the HomeLink customer support toll-free number. Do this, before going back to the dealer who sold you the car.

- Visit the HomeLink website at: [www.homelink.com](http://www.homelink.com). Then at the top of the page, choose your vehicle make. Then watch the YouTube video, and/or access additional website information.
- If you choose to access the website via your cell phone, scan the QR code.



- Or, call HomeLink customer support at 1-800-355-3515 (Please have the vehicle make/model AND the opener device make/model readily available.)

### 1) Programming Preparation



1. When programming a garage door opener, it is advised to park the vehicle outside of the garage.

2. It is recommended that a new battery be placed in the handheld transmitter of the device being programmed to HomeLink for quicker training and accurate transmission of the radio-frequency signal.
3. Place the ignition switch to the ACC (Accessory) position for programming of HomeLink.

### 2) Programming a New HomeLink®

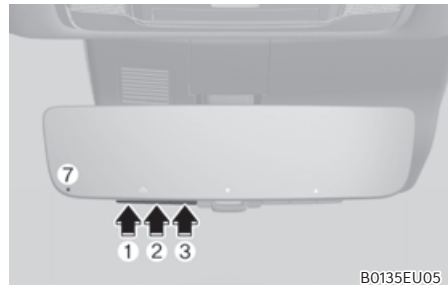

1. Press and release the HomeLink button (1), (2) or (3), you would like to program. The HomeLink indicator light (7) will flash orange slowly (if not, perform the steps of “Erasing HomeLink Buttons” section, and start over).

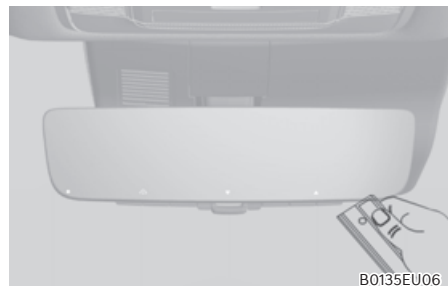

2. Position the garage door opener remote 1–3 inches (2–8 cm) away from the HomeLink buttons.

3. While the HomeLink indicator light ⑦ is flashing orange, press and hold the hand-held remote button. Continue pressing the handheld remote button until the HomeLink indicator light ⑦ light changes from orange to green. You may now release the handheld remote button.
4. Wait until your garage door comes to a complete stop, regardless of position, before proceeding to the next steps.
5. Press and release the HomeLink button you are programming and observe the indicator light.
  - If the indicator light remains solid green, your device should operate when the HomeLink button is pressed. At this point, if your device operates, programming is complete.
  - If the indicator light rapidly flashes green, firmly press, hold for two seconds and release the HomeLink button up to three times in a row slowly to complete the programming process. Do not press the HomeLink button rapidly. At this point if your device operates, programming is complete. If the device does not operate, continue with step 6.
6. At the garage door opener motor, (security gate motor, etc.) locate the “Learn”, “Smart”, “Set” or “Program” button. This can usually be found where the hanging antenna wire is attached to the motor-head unit (see the device’s manual to identify this button). The name and color of the button may vary by manufacturer.

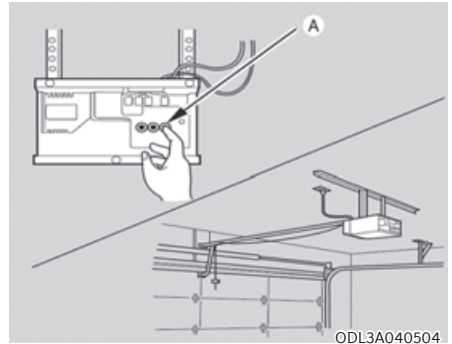

Ⓐ: LEARN BUTTON

- \* A ladder and/or second person may simplify the following steps.
7. Firmly press and release the “Learn”, “Smart”, “Set” or “Program” button. You now have up to 30 seconds in which to complete the next step.
  8. Return to the vehicle and firmly press, hold for two seconds and release, the HomeLink button up to three times in a row slowly. Do not press the HomeLink button rapidly. As soon as you see the garage door start to move, stop pressing any buttons until a few seconds after the garage door has come to a complete stop, regardless of position. At this point, programming is complete and your device should operate when the HomeLink button is pressed and released.

### 3) Two-Way Communication Programming (For select garage door openers)

If your garage door opener has the 'myQ' logo on its side, your opener likely has Two-Way Communication capability. HomeLink has the capability to establish Two-Way Communication with your garage door opener. HomeLink can receive and display "closing" or "opening" status messages from compatible garage door openers. At any time, Home-Link can also recall and display the last recorded status communicated by the garage door opener to indicate your garage door being "closed" or "opened".

To check if your garage door opener is compatible with this feature, refer to [www.homelink.com/compatible/Two-way-Communication](http://www.homelink.com/compatible/Two-way-Communication). If your garage door opener has this functionality, AND the Two-Way Communication indicators ④, ⑤ in the mirror appear while the garage door is opening/closing, then no further steps are needed. Two-Way Communication Programming is already complete. However, if your garage door opener has this functionality, AND the Two-Way Communication indicators ④, ⑤ in the mirror DO NOT appear while the garage door is opening/closing, use the following instructions to enable this functionality.

1. In your vehicle, press and hold the programmed HomeLink button for 2 seconds, then release. Confirm that the garage door is moving. AFTER it stops, you will have one minute to complete the following steps:
  - \* A ladder and/or second person may simplify the following steps.

2. On your garage door opener in your garage, locate the "Learn" button (usually near where the hanging antenna wire is attached to the garage door opener). If there is difficulty locating this button, reference the device's owner's manual.
3. Press and release the "Learn" button.
4. A light on your garage door opener may flash, and your Two-Way Communication indicators ④, ⑤ in your vehicle may flash, confirming completion of the process.
5. Return to the vehicle and firmly press and release the programmed HomeLink button to activate your garage door. The Two-Way Communication indicators ④, ⑤ flash in orange when the door is moving. Do not make any additional button presses until AFTER the garage door has come to a complete stop.
6. Your Two-Way Communication programming is now complete.

### Information

**If your garage door opener has Two-Way Communication functionality, it is possible for HomeLink to stop functioning the garage door shortly after initial programming, IF the Two-Way Communication Programming wasn't properly completed. This usually happens after the first 10 times a programmed HomeLink button is pressed. If you experience this, completing the "Programming a New HomeLink Button" and "Two-Way Communication Programming" will restore door operation.**

#### 4) Canadian Programming

Canadian radio-frequency laws require transmitter remote signals to “time-out” (or quit) after a couple seconds of transmission, which may not be long enough for HomeLink to pick up the signal during programming.

If you live in Canada or you are having difficulties programming a gate operator or garage door opener by using the programming procedures, replace “Programming a New HomeLink Button” step 3 with the following:

While the HomeLink indicator light ⑦ is flashing orange, press and release (“cycle”) your device’s handheld remote every two seconds until the HomeLink indicator light ⑦ changes from orange to green. You may now release the hand-held remote button. Then proceed with “Programming a New HomeLink Button” step 4.

## 2. Operating HomeLink®

### 1) Operating HomeLink®

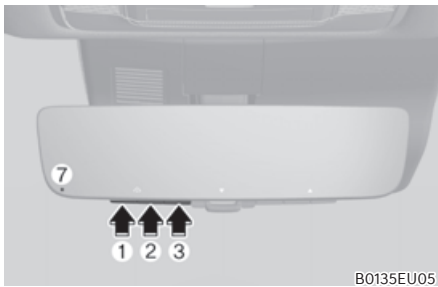

1. Press and release the desired programmed HomeLink button (①, ② or ③).

### **i** Information

**The HomeLink indicator ⑦ should light green, solid or flashing, and your programmed device should operate.**

**If your device does not operate, the HomeLink programming was not successful, and you’ll need to reprogram the button.**

### 2) Two-Way Communication Display Behavior

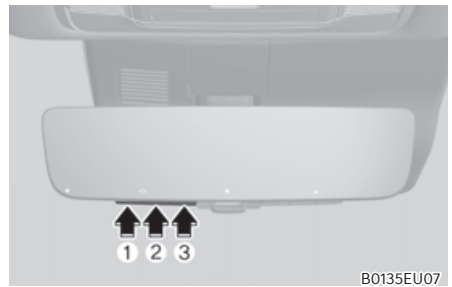

1. Press and release one of the programmed HomeLink buttons (①, ② or ③).

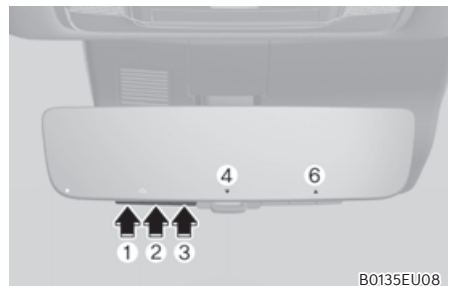

2. The indicator ④ and ⑥ operates as below, if your garage door opener has Two-Way Communication functionality.

- If the indicator ④ flashes in Orange, it indicates that the garage door is “Closing”.
- The indicator ④ turns solid green once the garage door has closed.
- If the indicator ⑥ flashes in Orange, it indicates that the garage door is “Opening”.
- The indicator ⑥ turns solid green once the garage door has fully opened.
- If the indicator ④ or ⑥ does not turn to green, it indicates that the last status of garage door was not received properly. The HomeLink mirror tries to receive the last known status of the garage door for a few seconds.

### 3) Recalling Garage Door Status

HomeLink mirror with Two-Way Communication provides a way to view the last stored message from the garage door opener. In order to recall the last known status of the last activated device, press the buttons “1 and 2” OR “2 and 3” simultaneously.

- If the indicator ④ appears solid Green, it indicates that the last activated device was “closed” properly.
- If the indicator ⑥ appears solid Green, it indicates that the last activated device was “open” properly.

### 3. Erasing HomeLink® Buttons

#### 1) Erasing and Reprogramming a Single HomeLink® Button:

1. Press and hold the desired HomeLink button you want to re-program. DO NOT release the button.
2. The HomeLink indicator light ⑦ will illuminate solid green. Release the button as soon as the HomeLink indicator light ⑦ begins to flash orange, usually about 20 seconds.
3. Proceed with the steps in the “Programming a New HomeLink Button” section.

#### Information

**If you do not complete the re-programming of a new device to the button, it will revert to the previously stored programming.**

#### 2) The following instructions will erase ALL HomeLink® programming from ALL buttons:

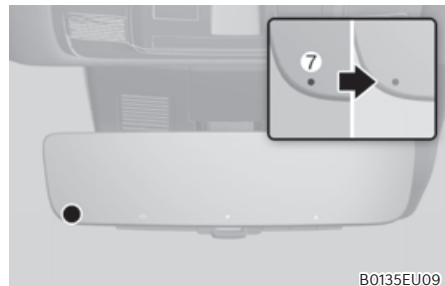

1. Press and hold the buttons ① and ③ simultaneously.
2. The HomeLink indicator light ⑦ will illuminate solid Orange for about 10 seconds.
3. Release the buttons once the HomeLink indicator light ⑦ changes to Green and flashes rapidly.
4. Now all three HomeLink buttons ①, ② and ③ are cleared of any programming.

## **i** Information

**HomeLink® and the HomeLink® House logo are registered trademarks of Gentex Corporation.**

**The myQ logo is a registered trademark of The Chamberlain Group, Inc.**

### **FCC (USA) and ISED (Canada)**

This device complies with FCC rules part 15 and Innovation, Science, and Economic Development Canada RSS-210. Operation is subject to the following two conditions: (1) This device may not cause harmful interference, and (2) This device must accept any interference that may be received including interference that may cause undesired operation. **WARNING:** The transmitter has been tested and complies with FCC and ISED rules. Changes or modifications not expressly approved by the party responsible for compliance could void the user's authority to operate the device.

This equipment complies with FCC and ISED radiation exposure limits set forth for an uncontrolled environment. End Users must follow the specific operating instructions for satisfying RF exposure compliance. This transmitter must be at least 20cm from the user and must not be co-located or operating in conjunction with any other antenna or transmitter.

### **FCC (Etats-Unis) et ISED (Canada)**

Cet appareil est conforme aux règlements de la FCC, section 15, et au CNR-210 d'Innovation, Sciences et Développement économique Canada. Le fonctionnement est assujéti aux deux conditions suivantes : (1) cet appareil ne doit pas causer d'interférences nuisibles et (2) cet appareil doit accepter toute interférence reçue, y compris celle qui pourrait entraîner un dysfonctionnement. **MISE EN GARDE :** L'émetteur a subi des tests et est conforme aux règlements de la FCC et d'ISDE. Les changements ou modifications non approuvés explicitement par la partie responsable de la conformité pourraient rendre caduque l'autorisation de l'utilisateur de se servir du dispositif.

Cet appareil est conforme aux limites d'exposition aux radiations de la FCC et d'ISDE établies pour un environnement non contrôlé. Les utilisateurs finaux doivent respecter les instructions d'utilisation spécifiques pour satisfaire aux exigences de conformité aux expositions de RF. L'émetteur doit se trouver à 20 cm au minimum de l'utilisateur et ne doit pas être situé au même endroit que tout autre émetteur ou antenne ni fonctionner avec un autre émetteur ou antenne.

### **Méjico**

La operación de este equipo está sujeta a las siguientes dos condiciones: (1) es posible que este equipo o dispositivo pueda no causar interferencia dañina, y (2) este dispositivo o dispositivos deben aceptar cualquier interferencia, que incluye la interferencia que puede causar su operación no deseada.



### HomeLink 5 Proaming Flow Chart

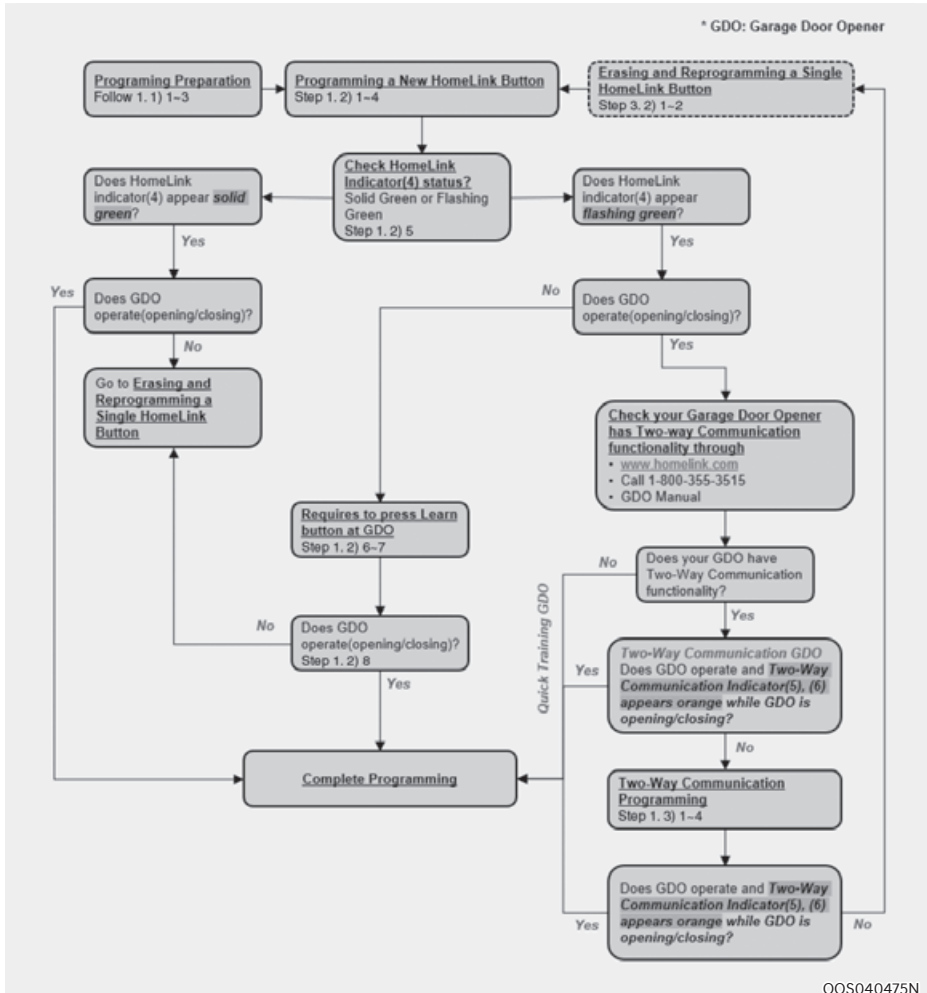

OOS040475N

## Side View Mirrors

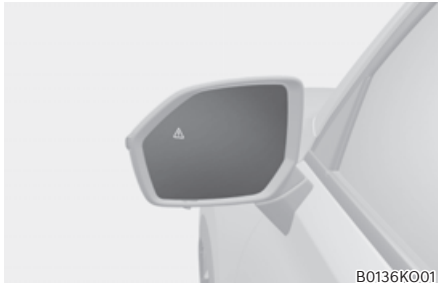

Your vehicle is equipped with both left-hand and right-hand side view mirrors. The mirrors can be adjusted with the mirror adjustment control switch. The side view mirrors can be folded to help prevent damage when going through an automatic car wash or when passing through a narrow street.

The right side view mirror is convex. Objects seen in the mirror are closer than they appear.

Use the inside rear view mirror or look back directly to determine the actual distance of other vehicles prior to changing lanes.

Make sure to adjust the side view mirrors to your desired position before you begin driving.



### WARNING

Do not adjust or fold the side view mirrors while driving. This may cause loss of vehicle control resulting in an accident.

### NOTICE

- Do not scrape ice off the mirror face; this may damage the surface of the glass.
- If the mirror is jammed with ice, do not adjust the mirror by force. Use an approved de-icer (not radiator antifreeze) spray, or a sponge or soft cloth with very warm water, or move the vehicle to a warm place and allow the ice to melt.
- Do not clean the mirror with harsh abrasives, fuel or other petroleum based cleaning products.

### Adjusting the side view mirrors



B0136EU01

Adjusting the side view mirrors

1. Move the lever ① either to the L (left side) or R (right side) to select the side view mirror you would like to adjust.
2. Use the mirror adjustment control switch ② to position the selected mirror up, down, left or right.
3. After adjustment, move the lever ① to the middle to prevent inadvertent adjustment.

#### **NOTICE**

- **The mirrors stop moving when they reach the maximum adjusting angles, but the motor continues to operate while the switch is placed. Do not press the switch longer than necessary, because this can damage the motor.**
- **Do not attempt to adjust the side view mirrors by hand, because this can damage the motor.**

### Folding the side view mirrors

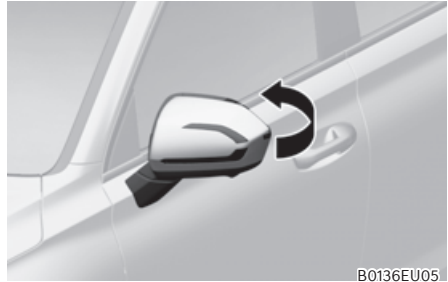

B0136EU05

To fold the side view mirror, grasp the housing of the mirror and then fold it toward the rear of the vehicle.

## Reverse Parking Aid (if equipped)

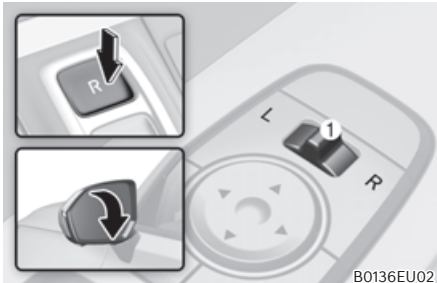

When the gear is shifted to the R (Reverse) position, the side view mirror(s) will rotate downwards to aid with driving in reverse.

The state of the side view mirror button ① determines whether or not the mirrors will move:

How it works

- When the L or R switch ① is selected both side view mirrors will move.
- If the L and R switch ① are not selected both outer side view mirrors will not move.

The side view mirrors will automatically revert to their original positions if any of the following occur:

- The ignition switch is placed to either the LOCK/OFF position or the ACC position.
- The gear is shifted to any position except R (Reverse).
- The side view mirror adjustment button is not selected.

## Reverse parking aid user settings mode

You may change the angle of the side view mirror if it is difficult to see the rear view with the basic downward mirror angle provided when reversing.

When the vehicle is first delivered, the set downward angle of the left and right side view mirror are different to ensure driver visibility.

1. Make sure the vehicle is stopped.
2. Depress the brake pedal and shift the gear to R (Reverse). When L (Left) or R (Right) switch is selected, both side view mirror angle will move downward to the basic set position.
3. Operate either L or R switch to select the side view mirror you would like to adjust. Then press “▼, ▲, ◀, ▶” switch to adjust the side view mirror to the desired angle.
4. After adjusting the angle to save the adjusted side view mirror angle, shift the gear to another position other than R (Reverse), or change the L and R buttons to the neutral position (L and R switches are not pressed).
5. Set the opposite side view mirror following the above procedure 1 to 4.

## Resetting reverse parking aid user settings mode

To change the side view mirror angle back to the basic angle, shift the gear to R (Reverse), and adjust the mirror angle higher than when the gear is in P (Park), N (Neutral) and D (Drive).

## NOTICE

**When changing the angle of both side view mirrors, it is recommended to change the angle one side at a time following the procedure 1 to 4.**

## DIGITAL CENTER MIRROR (IF EQUIPPED)

The Digital Center Mirror is a system that uses the camera on the rear of the vehicle and displays its image on the screen of the Digital Center Mirror. The Digital Center Mirror allows the driver to see the rear view despite obstructions, such as the headrest or luggage, ensuring rear visibility.

### WARNING

- **Failure to follow the warnings and instructions for proper use of the Digital Center Mirror could result in serious accident.**
  - **The Digital Center Mirror is a convenience feature but it is not a substitute for proper vehicle operation. The system has areas where objects cannot be viewed. Check the blind spot of the Digital Center Mirror before vehicle operation. The driver is always responsible for safe driving.**
  - **Do not operate the Digital Center Mirror while driving. Doing so cannot be a distraction and it could lose control of your vehicle and cause an accident or serious injury.**
  - **Do not disassemble or modify the Digital Center Mirror, the camera unit or wirings. If you do, it may result in accidents or fire. In case you notice smoke or smell coming from the Digital Center Mirror, stop using the system immediately. Have you see an authorized HYUNDAI dealer for servicing.**

- **Be sure to adjust the Digital Center Mirror before driving.**
  - **Switch the system to the conventional rearview mirror mode and be properly seated on the driver's seat. Then adjust the mirror so as to see the rear window properly.**
  - **Push the lever all the way to change to digital mirror mode and adjust the display settings. Driving without adjusting the mirror may cause difficulty in watching the display at the Digital Mirror mode (camera view mode) due to the reflection from the surface of the mirror.**
  - **As the range of the image display by the Digital Center Mirror is different from that of the optical mirror, make sure to check this difference before driving.**
- **If the Digital Center Mirror malfunction, immediately switch the system to the conventional rearview mirror mode.**
- **When strong light (for example, sunlight or high beams from following vehicles) enters the camera, a light beam or a glaring light may appear on the monitor screen of the Digital Center Mirror. In that case, switch the system to the conventional rearview mirror mode appropriately.**



B0362K001

If the camera lens ① is dirty, the displayed image may not be clear. In this case, clean it with a soft cloth dampened with water or a swab.

## System component

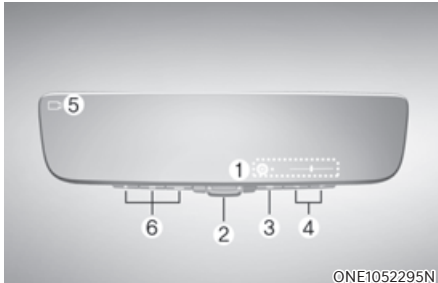

1. Icon display area  
Displays icons, adjusting Brightness & Tilt
2. Lever  
Operate to change between digital mirror mode and optical mirror mode.
3. Menu button  
Press to display the icon display area and select the item you want to adjust (Brightness & Tilt).
4. Select/adjust button  
Press to change the setting of the item you want to adjust.
5. Camera indicator  
Indicates that the camera is operating normally.
6. HomeLink buttons  
For the operation of the “HomeLink® Universal Transceiver”.

## How to change the mode

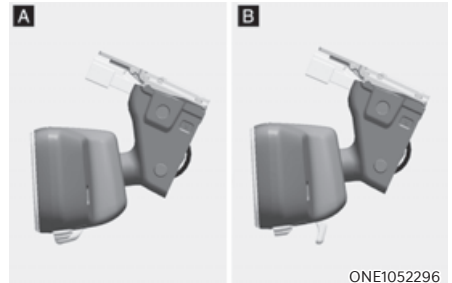

The mode can be switched when the switch is in the ON position.

1. Pull the mode select lever to all the way switch to the Digital Center Mirror mode (camera view mode).
  - \* Displays an image of the area behind the vehicle. In this mode, camera indicator © is shown.
2. Push the mode select lever to all the way switch to the optical inside rearview mirror mode
  - \* Turns off the display of the Digital Center Mirror allows it to be used as an optical mirror.

### Adjusting the mirror height



B0913EU03

The height of the rearview mirror can be adjusted to suit your driving posture. Change to optical mirror mode, adjusting the rearview mirror angle by moving it up and down.

### Display settings (Digital mirror mode)

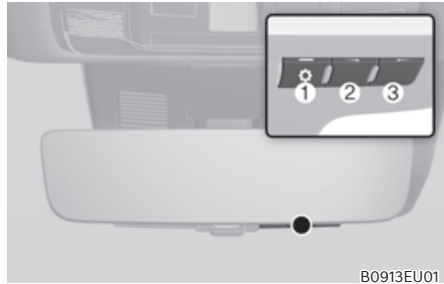

B0913EU01

1. Press the menu button ①. The icons will be displayed.

Icons	Settings
	Select to adjust the brightness of the display.
	Select to adjust the display up/down.

2. Press the menu button ① repeatedly and select the item you want to adjust.
3. Press the button ② or button ③ to change the setting.

The icons will disappear if the button is not operated for approximately 5 seconds or more.

- \* If the brightness of the Digital Center Mirror is set too high, it may cause eye strain.

Adjust the Digital Center Mirror to an appropriate brightness. If your eyes become tired, change to optical mirror mode.

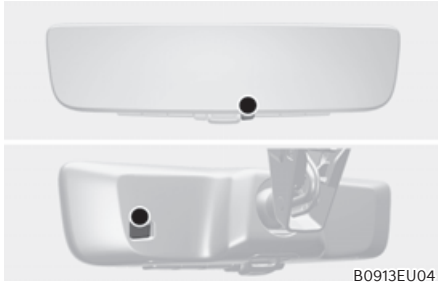

**To prevent the light sensors from malfunctioning**

To prevent the light sensors from malfunctioning, do not touch or cover them.

***Digital mirror mode operating condition***

The START/STOP button is in the ON position.

When the START/STOP button is changed ignition switch LOCK/OFF or ACC position, the image will be disappeared.

***When using the Digital Center Mirror in digital mirror mode***

- When the liftgate is open, the Digital Center Mirror image may not display properly. Before driving, make sure the liftgate is closed.
- If the display is difficult to see due to reflected light, close the sunshade for the sunroof (if equipped).
- Any of the following conditions may occur when driving in the dark, such as at night. None of them indicates that the malfunction has occurred.
  - Colors of objects in the displayed image may differ their actual color.
  - Depending on your physical condition or age, it may take longer than usual to focus on the displayed image. In this case, change to optical mirror mode.
  - Do not let passengers stare at the displayed image when the vehicle is being driven, as doing so may cause motion sickness.



### *When the system malfunctions*

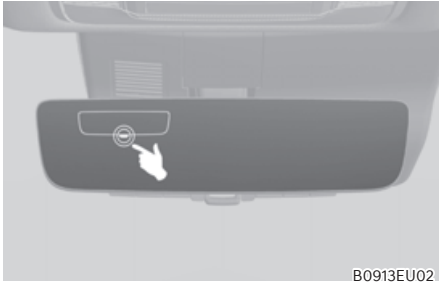



If the symbol shown in the illustration is displayed when using the Digital Center Mirror in digital mirror mode, the system may be malfunctioning. The symbol will disappear in a few seconds. Operate the lever, change to optical mirror mode and have the vehicle inspected by an authorized HYUNDAI dealer.

### **CAUTION**

- To prevent the Digital Center Mirror from malfunctioning
  - Do not use detergents, such as thinner, benzene, and alcohol to clean the mirror. They may discolor, deteriorate or damage the mirror surface.
  - Do not remove, disassemble or modify the mirror and camera.
  - Do not allow an organic solvent, vehicle wax, window cleaner or glass coating to adhere to the camera. If this happens, wipe it off as soon as possible.
  - When cleaning the camera lens, wipe the camera lens with a damp soft cloth.
  - Do not strongly rub the camera lens, as it may be scratched and will not be able to transmit a clear image.
- Do not subject the camera to a strong impact as this could cause a malfunction. If this happens, we recommend that you have the vehicle inspected by an authorized HYUNDAI dealer as soon as possible.
  - Operating the system at the ON position while the engine is not running would cause discharging of the battery.
  - Do not attach an antenna of wireless device near the Digital Center Mirror. Electric wave from wireless device may cause disturbed image in Digital Center Mirror.
  - Do not push buttons excessively or operating the lever roughly may cause a system failure or the Digital Center Mirror itself to drop.
  - Never rotate the body of Digital Center Mirror by 90° or more. It may damage the Digital Center Mirror. Do not apply strong shocks to the body of Digital Center Mirror. It may cause a system failure.
  - If it is difficult to see the Digital Center Mirror display screen because of a strong external light, switch the mode to the conventional rearview mirror mode for better use.

**Digital Center Mirror error icon and solution**

Symptom	Likely cause	Solution
<p>If the high temp icon is displayed on the display right side.</p> 	<p>The Digital Center Mirror is extremely hot. (The display will gradually become more dim. If the temperature continues to increase, the Digital Center Mirror will turn off.)</p>	<p>Reducing the cabin temperature is recommended to reduce the temperature of the mirror. (The icon will disappear when the mirror becomes cool.) If the icon does not disappear even though the mirror is cool, have the vehicle inspected by an authorized HYUNDAI dealer.</p>
<p>If the display icon  has been switched to  which is the display error icon.</p>	<p>The system may be malfunctioning.</p>	<p>Change to optical mirror mode and have the vehicle inspected by an authorized HYUNDAI dealer.</p>

## WINDOWS

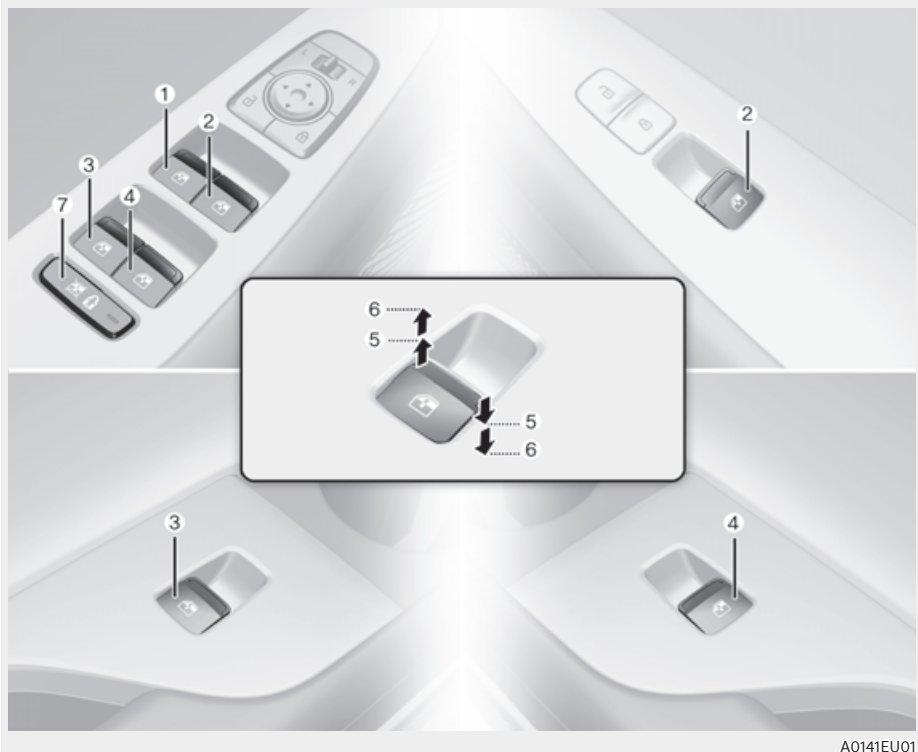

A0141EU01

- ① Driver's door power window switch
- ② Front passenger's door power window switch
- ③ Rear door (left) power window switch
- ④ Rear door (right) power window switch
- ⑤ Window opening and closing
- ⑥ Automatic power window
- ⑦ Power window lock switch/  
Electronic child safety lock

## Power Windows

The ignition switch or Engine Start/Stop button must be in the ON position to be able to raise or lower the windows. Each door has a Power Window switch to control that door's window. The driver has a Power Window Lock button which can block the operation of rear passenger windows. The power windows will operate for approximately 3 minutes after the ignition switch or Engine Start/Stop button is in the ACC or LOCK/OFF position, as long as the front doors remain closed.

If the front doors are opened, battery power is turned OFF and the Power Windows will not operate.

### **i** Information

- **In cold and wet climates, power window may not work properly due to freezing conditions.**
- **While driving with the rear windows down or with the sunroof (if equipped) opened (or partially opened), your vehicle may demonstrate a wind buffeting or pulsation noise. This noise is normal and can be reduced or eliminated by taking the following actions. If the noise occurs with one or both of the rear windows down, partially lower both front windows approximately 1 inch (2.5 cm). If you experience the noise with the sunroof open, slightly close the sunroof.**

## Window opening and closing

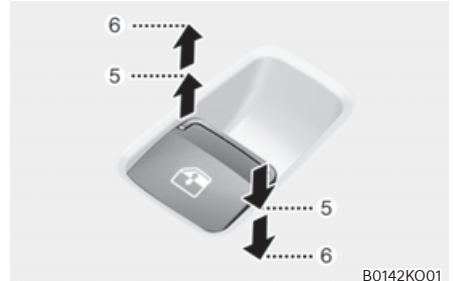

To open:

Press the window switch down to the first detent position ⑤. Release the switch when you want the window to stop.

To close:

Pull the window switch up to the first detent position ⑤. Release the window switch when you want the window to stop.

### **Auto up/down window**

Pressing or pulling up the power window switch momentarily to the second detent position ⑥ completely lowers or lifts the window even when the switch is released. To stop the window at the desired position while the window is in operation, pull up or press down and release the switch.



### **WARNING**

- **Do not leave the engine running and the key in your vehicle with unsupervised children. Unattended children could operate the window, which could result in serious injury.**
- **Do not extend your head, arms or any other body parts or objects outside the window while driving to avoid serious injury.**

### **Resetting the power windows**

If the power windows do not operate normally, the automatic power window system must be reset as follows:

1. Place the ignition switch or Engine Start/Stop button to the ON position.
2. Close the window and continue pulling up on the power window switch for at least one second.

If the power windows do not operate properly after resetting, have the system be inspected by an authorized HYUNDAI dealer.



### **WARNING**

**The automatic reverse feature doesn't activate while resetting the power window system.**

**Make sure body parts or other objects are safely out of the way before closing the windows to avoid injuries or vehicle damage.**

### **Automatic reverse**

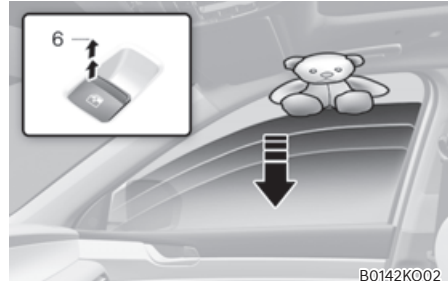

B0142K002

If a window senses any obstacle while it is closing automatically, it will stop and lower approximately 12 in. (30 cm) to allow the object to be cleared.

If the window detects the resistance while the power window switch is pulled up continuously, the window will stop upward movement then lower approximately 1 in. (2.5 cm).

If the power window switch is pulled up continuously again within 5 seconds after the window is lowered by the automatic window reverse feature, the automatic window reverse will not operate.

## **i** Information

The automatic reverse feature is only active when the “Auto Up” feature is used by fully pulling up the switch to the second detent.

## **!** WARNING

Make sure body parts or other objects are safely out of the way before closing the windows to avoid injuries or vehicle damage.

Objects less than 0.16 in. (4 mm) in diameter caught between the window glass and the upper window channel may not be detected by the automatic reverse window and the window will not stop and reverse direction.

## **NOTICE**

Do not install any accessories on the windows. The automatic reverse feature may not operate.

## Power window lock button



B0142K003

The driver can disable the power window switches on the rear passenger doors by pressing the power window lock button.

When the power window lock button is pressed:

- The rear passenger control will not be able to operate the rear passenger power window.
- Note that the front passenger control is still able to operate the front passenger window, and that the driver master control can still operate all the power windows.

## **!** WARNING

Do not allow children to play with the power windows. Keep the driver's door power window lock button in the LOCK position. Serious injury or death can result from unintentional window operation by a child.

## **NOTICE**

- To prevent possible damage to the power window system, do not open or close two windows or more at the same time. This will also ensure the longevity of the fuse.
- Never try to operate the main switch on the driver's door and the individual door window switch in opposite directions at the same time. If this is done, the window will stop and cannot be opened or closed.

**Remote window opening function (if equipped)**

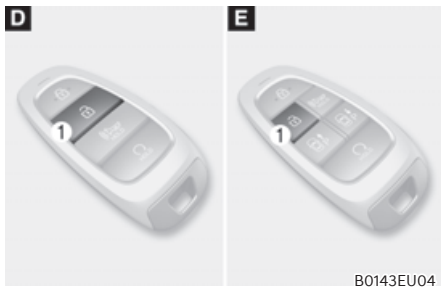
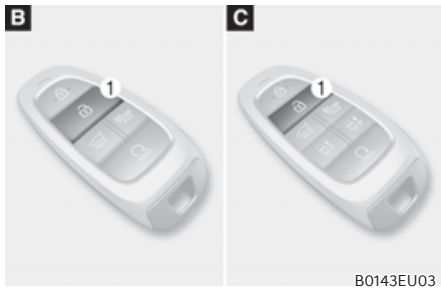

You can still control the window movement with the engine turned off.

Press the Door Unlock button ① for more than 3 seconds. The window moves down after the doors are unlocked, as long as you press the door unlock button. The window movement stops, when you release the door unlock button.

**⚠ WARNING**

If you stay on the function after operating the Remote window opening function, it is likely to cause a theft. In addition, please use caution there might be a malfunction due to the inflow of water while raining.

**i Information**

- The remote window opening function may abruptly stop, when you move away from your vehicle during operation. Stay in close proximity from your vehicle, while monitoring the window movement.
- One of the windows may stop operating, when the window is interrupted by certain force. However, the other windows will keep operating. Thus, you should make sure that all windows are opened.
- Please be aware that the doors unlock when the windows are opened using the remote window opening function.

## PANORAMIC SUNROOF (IF EQUIPPED)

If your vehicle is equipped with a sunroof, you can slide or tilt your sunroof with the sunroof switch located on the overhead console.



B0903EU01

The sunroof can only be operated when the ignition switch or Engine Start/Stop button is in the ON or START position.

The sunroof can be operated for approximately 3 minutes after the ignition switch or Engine Start/Stop button is in the ACC or LOCK/OFF position. However, if the front door is open, the sunroof cannot be operated even within the 3 minutes period.



### WARNING

- **Adjust the sunroof or sunshade when your vehicle stops. This could result in loss of control and an accident that may cause injury, or property damage.**
- **Do not leave the engine running and the key in your vehicle with unsupervised children. Unattended children could operate the sunroof, which could result in serious injury.**
- **Do not sit on the top of the vehicle. It may cause injury or vehicle damage.**

### NOTICE

**Do not operate the sunroof when roof bars are installed on the vehicle or when there is luggage on the roof.**

## Power Sunshade



B0904K001

Use the sunshade to block direct sunlight coming through the sunroof glass.

Open or close the sunshade by hand.

### NOTICE

**Do not pull the sunshade up or down, or apply excessive force as such action may damage the sunshade or cause it to malfunction.**



### Information

The sunshade opens automatically when the sunroof glass is opened, but the sunshade does not close automatically when the sunroof glass is closed. Also, only the sunshade cannot be closed when the sunroof glass is opened.



## Tilt Open/Close



- Push the sunroof switch upward, the sunroof glass tilts open.
- Push the sunroof switch forward when the sunroof glass is tilt opened, the sunroof glass closes.

The sunroof glass tilts open or closes while the switch is pushed.

### **i** Information

**The sunroof glass cannot slide open and tilt open at the same time. You cannot tilt the sunroof glass open while the sunroof glass is slide open. Also, you cannot slide the sunroof glass open while the sunroof is tilt open. Slide open or tilt open the sunroof glass when the sunroof glass is completely closed.**

## Slide Open/Close



- Push the sunroof switch rearward, the sunshade and sunroof glass slide open.  
Push the sunroof switch forward, only the sunroof glass closes.
- Push the sunroof switch forward or rearward to the first detent position, the sunroof glass moves until the switch is released.
- Push the sunroof switch forward or rearward to the second detent position, the sunroof glass operates automatically (auto slide feature). To stop the sunroof movement at any point, push the sunroof switch in any direction.
- The sunroof glass stops halfway (first detent position) before it is fully opened. To fully open the sunroof glass, push the sunroof switch rearward once more. At this time, the sunroof glass opens only while the switch is pushed.

### **i** Information

**To reduce wind noise while driving, we recommend that you drive at the recommended position (first detent position) before the maximum slide open position.**

## Automatic Reversal

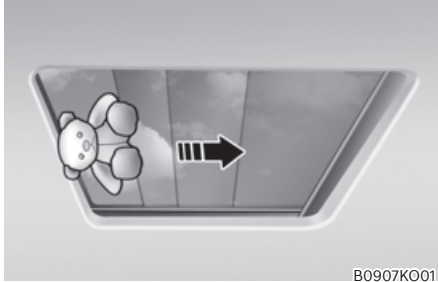

If the sunroof glass senses any obstacle while it is closing automatically, it will reverse direction then stop at a certain position.

The auto reverse function may not work if an object thin or soft is caught between the sliding sunroof glass and sunroof sash.



### WARNING

- Make sure heads, hands, arms or any other body parts or objects are out of the way before operating the sunroof. Body parts or objects may get caught causing injuries or vehicle damage.
- Never deliberately use your body parts to test the automatic reversal function. The sunroof glass may reverse direction, but there is a risk of injury.

### NOTICE

- Do not continue to push the sunroof switch after the sunroof is fully opened, closed, or tilted. Damage to the sunroof motor could occur.
- Continuous operations such as slide open/close, tilt open/close, etc. may cause the motor or sunroof system to malfunction.
- Regularly remove any accumulated dust on the sunroof rail.
- Dust accumulated between the sunroof and roof panel can make noise. Open the sunroof and remove dust regularly using a clean cloth.
- Do not try to open the sunroof when the temperature is below freezing or when the sunroof is covered with snow or ice. The sunroof may not work properly and may break if opened by force.
- Do not open or drive with the sunroof glass open immediately after rain or washing the vehicle. Water may wet the interior of the vehicle.
- Do not extend any luggage outside the sunroof while driving. Vehicle damage may occur if the vehicle suddenly stops.



### WARNING

Do not extend your head, arms, body parts or objects outside the sunroof while driving. Injuries may occur if the vehicle suddenly stops.

### Resetting the Sunroof



In some circumstances resetting the sunroof operation may need to be performed. Some instances where resetting the sunroof may be required include:

- When the 12-volt battery is either disconnected or discharged
- When the sunroof fuse is replaced
- If the sunroof one-touch AUTO OPEN/CLOSE operation is not functioning properly

Sunroof resetting procedure:

1. It is recommended to perform the reset procedure with the vehicle engine running. Start the vehicle in P (Park).
2. Make sure the power sunshade and sunroof glass are in the fully closed position. If the power sunshade and sunroof glass is open, push the switch forward until the power sunshade and sunroof glass are fully closed.
3. Release the switch when the power sunshade and sunroof glass are fully closed.
4. Push the switch forward until the power sunshade and sunroof glass move slightly. Then release the switch.

5. Once again push and hold the sunroof switch forward until the power sunshade and sunroof glass slide open and close. Do not release the switch until the operation is completed.  
If you release the switch during operation, start the procedure again from step 2.

### **i** Information

**If the sunroof does not reset when the vehicle battery is disconnected or discharged, or the sunroof fuse is blown, the sunroof may not operate normally.**

## Sunroof Open Warning

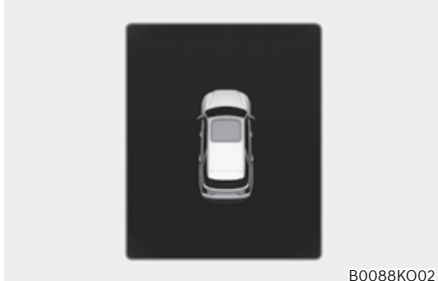

If the driver turns off the engine when the sunroof is not fully closed, the warning chime will sound for several seconds and the sunroof open warning will appear on the cluster LCD display. Close the sunroof securely when leaving your vehicle.



### CAUTION

Make sure the sunroof is closed fully when leaving your vehicle. If the sunroof is left open, rain or snow may wet the interior of the vehicle. Also, leaving the sunroof open when the vehicle is unattended may invite theft.

## DUAL SUNROOF (IF EQUIPPED)

If your vehicle is equipped with a sunroof, you can slide or tilt your sunroof with the sunroof switch located on the overhead console.

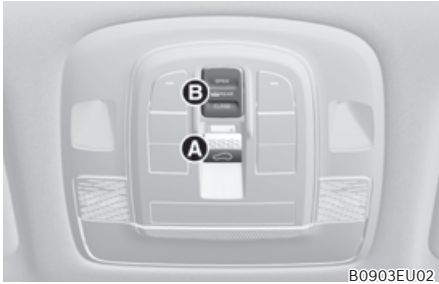

Ⓐ: Front, Ⓑ: Rear

The sunroof can only be operated when the ignition switch or Engine Start/Stop button is in the ON or START position.

The sunroof can be operated for approximately 30 seconds after the ignition switch or Engine Start/Stop button is in the ACC or LOCK/OFF position.

However, if the front door is open, the sunroof cannot be operated even within the 3 minute period.

### WARNING

- Adjust the sunroof or sunshade when your vehicle stops. This could result in loss of control and an accident that may cause injury, or property damage.
- Do not leave the engine running and the key in your vehicle with unsupervised children. Unattended children could operate the sunroof, which could result in serious injury.
- Do not sit on the top of the vehicle. It may cause injury or vehicle damage.

### **NOTICE**

**Do not operate the sunroof when roof bars are installed on the vehicle or when there is luggage on the roof.**

### Information

**When the rear power window switches are disabled using the power window lock button, the rear sunroof operation switch is also disabled. If you need to operate the rear seat sunroof, operate the rear seat sunroof with the front sunroof operation switch.**

### Sunshade (Front)/Power sunshade (Rear)

Use the sunshade to block direct sunlight coming through the sunroof glass.



B0904K001

#### Front

Open or close the sunshade by hand.

### **i** Information



B0904K002

The sunshade opens automatically when the sunroof glass is opened by pushing the sunroof switch **A** rearward, but the sunshade does not close automatically when the sunroof glass is closed. Also, only the sunshade cannot be closed when the sun roof glass is opened.

### **NOTICE**

Do not pull the sunshade up or down, or apply excessive force as such action may damage the sunshade or cause it to malfunction.

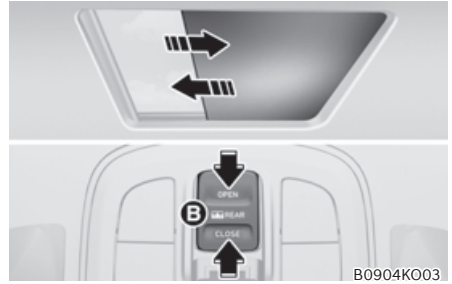

B0904K003

#### Rear

Push the power sunshade open switch **B**, the power sunshade automatically slides open.

Push the power sunshade close switch **B**, the power sunshade automatically closes.

### **NOTICE**

Do not pull or push the power sunshade by hand as such action may damage the power sunshade or cause it to malfunction.

### **i** Information

Wrinkles formed on the power sunshade are normal due to material characteristic.

### Tilt open/close (Front)

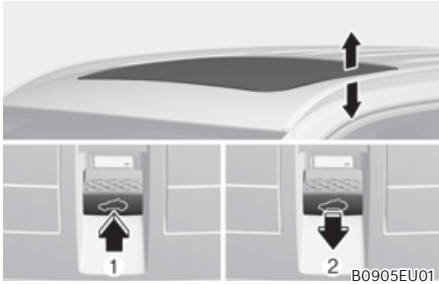

- ①: Tilt open
- ②: Tilt close

- Push the sunroof switch upward, the sunroof glass tilts open.
- Push the sunroof switch forward when the sunroof glass is tilt opened, the sunroof glass closes.

The sunroof glass tilts open or closes while the switch is pushed.

### Slide open/close (Front/Rear)

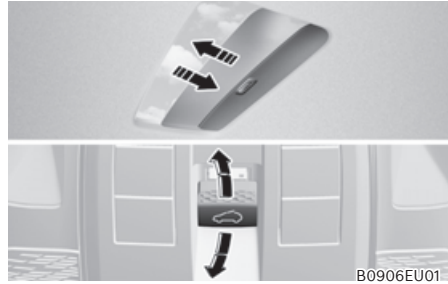

- Push the sunroof switch rearward, the sunshade and sunroof glass slide open.
- Push the sunroof switch forward, only the sunroof glass closes.
- Push the sunroof switch forward or rearward to the first detent position, the sunroof glass moves until the switch is released.
- Push the sunroof switch forward or rearward to the second detent position, the sunroof glass operates automatically (auto slide feature). To stop the sunroof movement at any point, push the sunroof switch in any direction.

### Information

To reduce wind noise while driving, you drive at the recommended position (first detent position) before the maximum slide open position.

### Automatic reversal

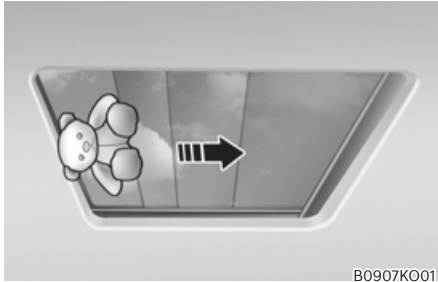

If the sunroof glass senses any obstacle while it is closing automatically, it will reverse direction then

The auto reverse function may not work if an object thin or soft is caught between the sliding sunroof glass and sunroof sash.

#### **WARNING**

- Make sure heads, hands, arms or any other body parts or objects are out of the way before operating the sunroof. Body parts or objects may get caught causing injuries or vehicle damage.
- Never deliberately use your body parts to test the automatic reversal function. The sunroof glass may reverse direction, but there is a risk of injury.

#### **NOTICE**

- Do not continue to push the sunroof switch after the sunroof is fully opened, closed, or tilted. Damage to the sunroof motor could occur.
- Continuous operations such as slide open/close, tilt open/close, etc. may cause the motor or sunroof system to malfunction.
- Regularly remove any accumulated dust on the sunroof rail.
- Dust accumulated between the sunroof and roof panel can make noise. Open the sunroof and remove dust regularly using a clean cloth.
- Do not try to open the sunroof when the temperature is below freezing or when the sunroof is covered with snow or ice. The sunroof may not work properly and may break if opened by force.
- Do not open or drive with the sunroof glass open immediately after rain or washing the vehicle. Water may wet the interior of the vehicle.
- Do not extend any luggage outside the sunroof while driving. Vehicle damage may occur if the vehicle suddenly stops.

#### **WARNING**

Do not extend your head, arms, body parts or objects outside the sunroof while driving. Injuries may occur if the vehicle suddenly stops.



### Resetting the sunroof



Ⓐ: Front, Ⓑ: Rear

In some circumstances resetting the sunroof operation may need to be performed. Some instances where resetting the sunroof may be required include:

- When the 12-volt battery is either disconnected or discharged
- When the sunroof fuse is replaced
- If the sunroof one-touch AUTO OPEN/CLOSE operation is not functioning properly

Sunroof resetting procedure:

1. It is recommended to perform the reset procedure with the vehicle engine running. Start the vehicle in P (Park).
2. Make sure the sunroof glass is in the fully closed position. If the sunroof glass is open, push the switch forward until the sunroof glass is fully closed.
3. Release the switch when the sunroof glass is fully closed.
4. Push the switch forward until the sunroof glass moves slightly. Then release the switch.
5. Once again push and hold the sunroof switch forward until the sunroof glass slides open and close. Do not release the switch until the operation is completed.

If you release the switch during operation, start the procedure again from step 2.

### **i** Information

**If the sunroof does not reset when the vehicle battery is disconnected or discharged, or the sunroof fuse is blown, the sunroof may not operate normally.**

### *Sunroof open warning*

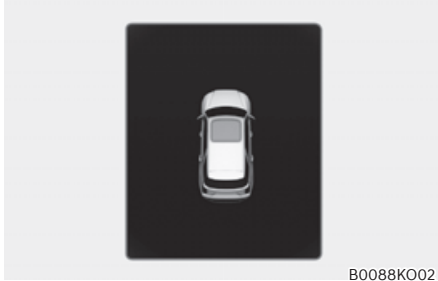

If the driver turns off the engine when the sunroof is not fully closed, the warning chime will sound for several seconds and the sunroof open warning will appear on the cluster LCD display. Close the sunroof securely when leaving your vehicle.



#### **CAUTION**

**Make sure the sunroof is closed fully when leaving your vehicle.**

**If the sunroof is left open, rain or snow may wet the interior of the vehicle.**

**Also, leaving the sunroof open when the vehicle is unattended may invite theft.**

## HOOD

### Opening the Hood

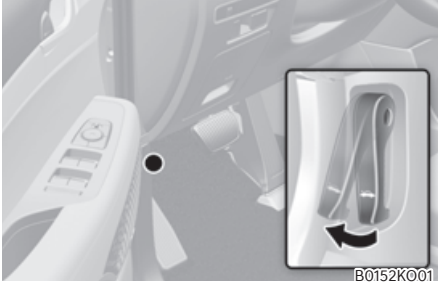

1. Park the vehicle and set the parking brake.
2. Pull the release lever to unlatch the hood. The hood should pop open slightly.



3. Go to the front of the vehicle, raise the hood slightly, push up the secondary latch ① inside of the hood center and lift the hood ②.

After the hood has been lifted halfway, it will raise completely by itself.

### Closing the Hood

1. Before closing the hood, check in and around the engine compartment to ensure the following:
  - Any tools or other loose objects are removed from the engine room area or hood opening area
  - All gloves, rags, or other combustibile material is removed from the engine compartment
  - All filler caps are tightly and correctly installed
2. Lower the hood halfway (lifted approximately 12 in. (30 cm) from the closed position) and push down to securely lock in place. Then double check to be sure the hood is secure. If the hood can be raised slightly, it is not securely locked. Open it again and close it with more force.



### WARNING

- Before closing the hood, ensure all obstructions are removed from around the hood opening.
- Always double check to be sure that the hood is firmly latched before driving away. Check there is no hood open warning light or message displayed on the instrument cluster. Driving with the hood opened may cause a total loss of visibility, which might result in an accident.
- Do not move the vehicle with the hood in the raised position, as vision is obstructed, which might result in an accident, and the hood could fall or be damaged.

## LIFTGATE

### Opening the Liftgate

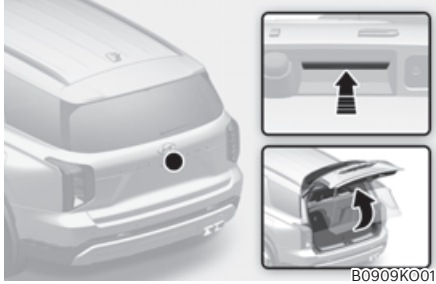

B0909KO01

Make sure the vehicle is in P (Park) and set the parking brake.

Then do one of the following:

1. Unlock all doors with the Door Unlock button on your smart key. Press the liftgate handle button and open the liftgate.
2. Press and hold the liftgate Open button on the smart key to unlock the liftgate. Then press the liftgate handle button on the vehicle and open the liftgate.
3. With the Smart Key in your possession, press the liftgate handle button and open the liftgate.

### Closing the Liftgate

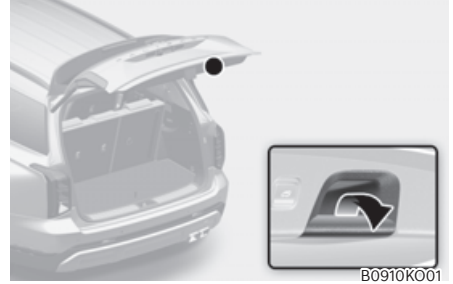

B0910KO01

Lower the liftgate lid and press down until it locks. To be sure the liftgate lid is securely fastened, always check by trying to pull it up again without pressing the liftgate handle button.



### WARNING

**Always keep the liftgate completely closed while the vehicle is in motion. If it is left open or ajar, poisonous exhaust gases containing carbon monoxide (CO) may enter the vehicle and serious illness or death may result.**

### NOTICE

**To prevent damage to the liftgate support struts and the attached hardware, always close the liftgate before driving.**



### Information

**In cold and wet climates, the liftgate lock mechanism and the liftgate support struts may not operate properly in extreme cold temperatures. Use caution when operating the liftgate in sub-zero freezing conditions.**

 **WARNING**



Do not grab or hold on to the liftgate support struts at any time. Damage to the liftgate support struts could result. Deformation of the liftgate support struts may cause vehicle damage and personal injury may occur.

 **WARNING**

- NEVER allow anyone to occupy the luggage compartment of the vehicle at any time. If the liftgate is partially or totally latched and the person is unable to get out, serious injury or death could occur due to lack of ventilation, exhaust fumes and rapid heat build-up, or because of exposure to cold weather conditions. The luggage compartment is also a highly dangerous location in the event of a crash because it is not a protected occupant space but is a part of the vehicle's crush zone.
- Your vehicle should be kept locked and keys should be kept out of the reach of children. Parents should teach their children about the dangers of playing in luggage compartments.

## Emergency Liftgate Safety Release

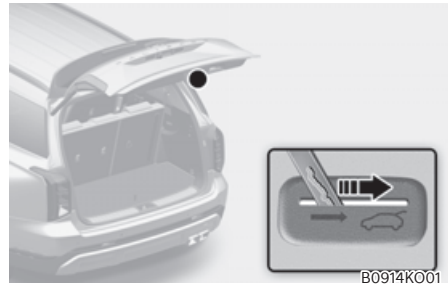

Your vehicle is equipped with the emergency liftgate safety release lever located on the bottom of the liftgate.

When someone is inadvertently locked in the luggage compartment, the liftgate can be opened by moving the lever in the direction of the arrow and pushing the liftgate open.

 **WARNING**

- For emergencies, be fully aware of the location of the emergency liftgate safety release lever in the vehicle and how to open the liftgate if you are accidentally locked in the luggage compartment.
- No one should be allowed to occupy the luggage compartment of the vehicle at any time. The luggage compartment is a very dangerous location in the event of a crash.
- Use the release lever for emergencies only. Use with extreme caution, especially while the vehicle is in motion.

## POWER LIFTGATE (IF EQUIPPED)

### Power Liftgate Operating Conditions

The power liftgate operates when the gear is in P (Park) with the engine running. However, the power liftgate will operate regardless of the gear position when the engine is off. Also, the liftgate can be opened only when vehicle speed is below 1.8 mph (3 km/h).

For safety, before attempting to open or close the liftgate, make sure the vehicle is in P (Park).



### WARNING

- **Never leave children or animals unattended in your vehicle. Children may operate the power liftgate. Doing so can result in injury to themselves or others and can damage the vehicle.**

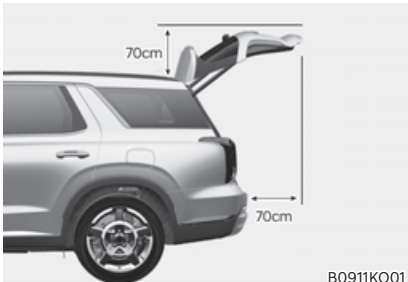

**Make sure that there are no people or objects in the path of the power liftgate or smart liftgate prior to use. Serious injury, damage to the vehicle or damage to surrounding objects (for example, walls, ceilings, vehicles, etc.) may result if contact with the liftgate occurs.**

### NOTICE

- **Do not close or open the liftgate manually. This may cause damage to the power liftgate. If it is necessary to close or open the liftgate manually when the battery is discharged or disconnected, do not apply excessive force.**
- **Do not operate the power liftgate more than 10 times continuously when the engine is not running. Use the power liftgate with the engine running when the power liftgate is used repeatedly to prevent battery discharge.**
- **Do not leave the power liftgate open for a long period of time. This may drain the battery.**
- **Do not apply excessive force when the power liftgate is operating. Doing so could result in vehicle damage.**



**Do not grab or hold on to the liftgate support struts at any time. Damage to the liftgate support struts could result. Deformation of the liftgate support struts may cause vehicle damage and personal injury may occur.**

- Do not modify or repair any part of the power liftgate by yourself. This must be done by an authorized HYUNDAI dealer.
- Do not operate the power liftgate under the following conditions. The power liftgate may not operate properly.
  - One side of the vehicle is lifted to inspect the vehicle or change a tire
  - Parking on an uneven road such as a slope, etc.
- Close the liftgate completely and lock all doors and liftgate using the central door lock button before using an automatic car wash.
- Do not spray high pressure water directly on the power liftgate outside open/close button. The liftgate may open unintentionally.

### Information

- If the liftgate is not fully closed and vehicle speed is at or above 3 km/h (1.8 mph), a warning will sound 10 times. Immediately park the vehicle at a safe place, close the liftgate, and check that the liftgate open warning on the instrument cluster is turned off.
- In cold and wet climates, the outside power liftgate open/close button may not work properly due to freezing conditions. If this occurs, remove the ice before using the outside power liftgate open/close button or use the power liftgate open/close button on the smart key or the instrument panel.
- Operating the power liftgate more than 5 times continuously could cause damage to the operating motor. If this occurs, the power liftgate will not operate to prevent the motor from overheating. If any of the power liftgate buttons are pressed to try to open the liftgate, the chime will sound 3 times, but the liftgate will remain closed. Allow the power liftgate system to cool for about 1 minute before operating the system again.

## Operating the Power Liftgate

### Power liftgate open/close button (Smart key, Instrument panel)

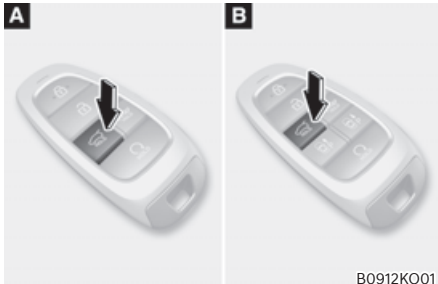

B0912K001



B0912K002

When the liftgate is closed, press the power liftgate open/close button for 1 second. The power liftgate opens with a warning sound.

When the power liftgate is opened, press the power liftgate open/close button for 1 second to close the liftgate.

While the liftgate is opening, press the button to stop liftgate operation.

### Power liftgate open/close button (Outside the power liftgate)

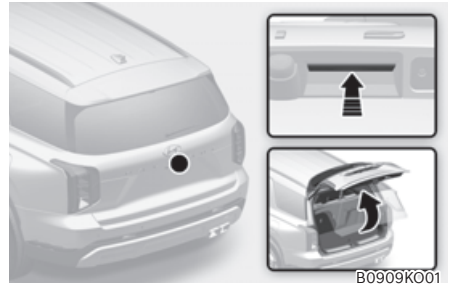

B0909K001

When the liftgate is closed, press the power liftgate open/close button to open the liftgate.

If the vehicle is locked, press the power liftgate open/close button with the smart key in your possession.

If the liftgate is unlocked, the liftgate will open or close with a warning sound when the power liftgate open/close button is pressed without carrying the smart key.

### Power liftgate open/close button (Inside the power liftgate)



B0913K001

Press the power liftgate open/close button. The liftgate opens or closes with a warning sound.



### **Automatic reverse**

During power liftgate operation if the power liftgate senses any obstacle, the liftgate will stop or will fully open. The automatic reverse feature may not operate properly, or it may operate unexpectedly under the following circumstances:

- The automatic reverse feature may not detect the resistance if the detected resistance is below a certain level, or if the liftgate is almost fully closed near the latched position.
- The automatic reverse feature may operate if a strong impact is applied with no obstructions placed.



### **WARNING**

**Never intentionally place any object or part of your body in the path of the power liftgate to make sure the automatic reverse feature operates. Serious injury, or damage to the vehicle or object may occur.**



### **Information**

**The power liftgate may stop operating if the automatic reverse feature operates more than two times while attempting to open or close the liftgate. If this occurs, carefully open or close the liftgate manually, and then after 30 seconds try to operate the power liftgate automatically again.**

### **Setting the Power Liftgate**

To use each feature, you must select the opening speed or opening height from the settings menu. Deselect the settings when you do not want to use the feature.

#### **Power liftgate opening speed**

To adjust the power liftgate speed, select 'User Settings → Door/Liftgate → Power Liftgate Opening Speed → Fast/Slow' in the instrument cluster or 'Setup → Vehicle → Door/Liftgate → Power Liftgate Opening Speed → Fast/Slow' in the infotainment system. (Default setting is 'Fast')

#### **Power liftgate opening height**

To adjust the power liftgate opening height, select 'User Settings → Door/Liftgate → Power Liftgate Opening Height → Full Open/Level 3/Level 2/Level 1/User Height Setting' in the instrument cluster or 'Setup → Vehicle → Door/Liftgate → Power Liftgate Opening Height → Full Open/Level 3/Level 2/Level 1/User Height Setting' in the infotainment system.

### User height setting

1. Position the liftgate manually to the height you prefer.
2. Press the power liftgate open/close button located inside the liftgate for more than 3 seconds.

If 'User Height Setting' is selected for the power liftgate opening height, the power liftgate will automatically open to the height manually set by you.

### **i** Information

- If the power liftgate opening height has not been manually set, the power liftgate will fully open when 'User Height Setting' from the infotainment system is selected.
- If one of the height setting (Full Open/Level 3/Level 2/Level 1) is selected from the settings menu in the infotainment system, and then 'User Height Setting' is selected, the liftgate will open to the height manually set by you.
- The power liftgate opening speed and opening height settings change according to the linked User Profile. If the User Profile is changed, power liftgate opening speed and opening height settings will change accordingly.
- The infotainment system may change after software updates. For more information, refer to the user's manual provided in the infotainment system and the quick reference guide.

### Resetting the Power Liftgate

In some circumstances resetting the power liftgate operation may need to be performed. Some instances where resetting the power liftgate may be required include:

- When the 12-volt battery is recharged
- When the 12-volt battery is reinstalled after removal or replacement
- When the related fuse is reinstalled after removal or replacement

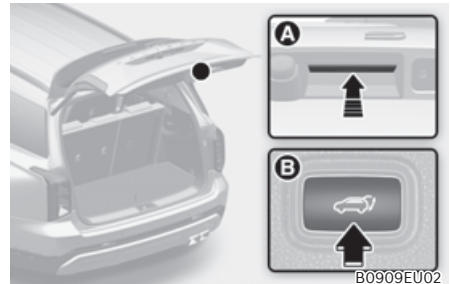

1. With the engine off or running, put the gear in P (Park).
2. Press the power liftgate open/close inner button **B** and outer button **A** simultaneously until a chime sounds.
3. Slowly close the liftgate manually.
4. Press the power liftgate open/close outer button. The power liftgate will open with a chime sound.

Wait until the liftgate fully opens to complete resetting. If the liftgate stops before it is fully open, resetting cannot be completed.

### **i** Information

If the power liftgate does not operate properly after the above procedure, have the system inspected by an authorized HYUNDAI dealer.

## Emergency Liftgate Safety Release

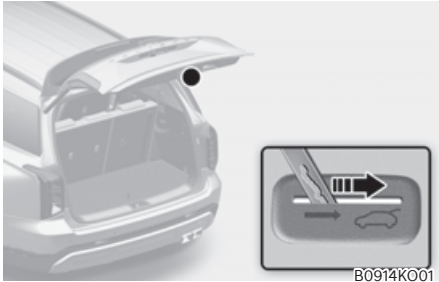

To unlock and open the liftgate manually from inside the luggage compartment, perform the following procedure:

1. Insert a long, flat object, such as a key into the opening at the bottom of the liftgate.
2. Slide the latch in the direction of the arrow to unlock the liftgate.
3. Push the liftgate to open.

### **WARNING**

- For emergencies, be fully aware of the location of the emergency liftgate safety release latch in the vehicle and how to open the liftgate if you are accidentally locked in the luggage compartment.
- No one, including animals, should be allowed to occupy the luggage compartment of the vehicle at any time. The luggage compartment is a very dangerous location in the event of an accident.
- Use the release latch for emergencies only. Use extreme caution, especially while the vehicle is in motion.

## SMART LIFTGATE (IF EQUIPPED)



On a vehicle equipped with a smart key, the liftgate can be opened with hands-free activation using the smart liftgate system.

### **WARNING**

**Make sure that there are no people or objects in the path of the smart liftgate prior to use. Serious injury, damage to the vehicle or damage to surrounding objects may result if contact with the smart liftgate occurs.**

## Using Smart Liftgate

The hands-free smart liftgate system can be opened automatically when the following conditions are met:

- The Smart Liftgate option is enabled in the instrument cluster or infotainment system.
- The smart liftgate is activated and ready 15 seconds after all the doors are closed and locked.
- The smart liftgate will open when the smart key is detected in the area behind the vehicle for 3 seconds.



### Information

The smart liftgate will **NOT** operate when:

- A door is not locked or closed.
- The smart key is detected within 15 seconds from when the doors were closed and locked.
- The smart key is detected within 15 seconds after the doors are closed and locked, and within 60 in. (1.5 m) from the front door handles. (for vehicles equipped with Welcome Light).
- The smart key is in the vehicle.

### 1. Settings

To use smart liftgate, it must be enabled from the Settings menu in the instrument cluster or infotainment system. Select:

- User Settings → Door → Smart Liftgate (for cluster type)
- Setup → Vehicle → Door → Smart Liftgate (for infotainment system type)

### 2. Detect and Alert

The smart liftgate detecting area extends approximately 20-40 in. (50-100 cm) behind the vehicle. If you are positioned in the detecting area and are carrying the smart key, the hazard warning lights will blink and the chime will sound to alert you that the smart liftgate will open.



### Information

- **Do not approach the detecting area if you do not want the liftgate to open. If you have unintentionally entered the detecting area and the hazard warning lights and chime starts to operate, move away from the area behind the vehicle with the smart key. The liftgate will remain closed.**
- **The infotainment system may change after software updates. For more information, refer to the user's manual provided in the infotainment system and the quick reference guide.**

### 3. Automatic opening

After the hazard warning lights blink and the chime sounds 6 times, the smart liftgate will open.

## Deactivating Smart Liftgate

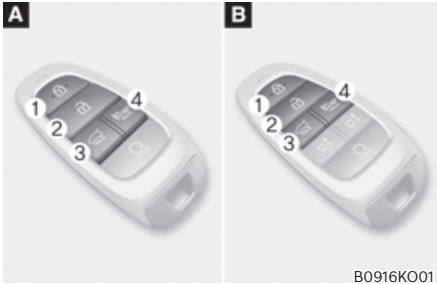

- ① Door lock
- ② Door unlock
- ③ Liftgate open/close
- ④ Panic

If you press any button on the smart key during the Detect and Alert stage, the smart liftgate will be deactivated.

Make sure to be aware of how to deactivate the smart liftgate for emergency situations.

- If you press the door unlock button ②, the smart liftgate will be deactivated temporarily. But, if you do not open any door for 30 seconds, the smart liftgate will be activated again.
- If you press the liftgate open button ③ for more than 1 second, the liftgate opens.
- The smart liftgate will still be activated if you press the door lock button ① or liftgate open/close button ③ on the smart key as long as the smart liftgate is not already in the Detect and Alert stage.
- In case you have deactivated the smart liftgate by pressing the smart key button and opened a door, the smart liftgate can be activated again by closing and locking all doors.

## Detecting Area



- The smart liftgate detecting area extends approximately 20-40 in. (50-100 cm) behind the vehicle. If you are positioned in the detecting area and are carrying the smart key, the hazard warning lights will blink and the chime will sound for about 3 seconds to alert you that the liftgate will open.
- The alert stops once the smart key is moved outside of the detecting area within the 3 second period.

### **i** Information

- **Smart liftgate may not operate properly if any of the following occur:**
  - **The smart key is close to a radio transmitter such as a radio station or an airport which can interfere with normal operation of the transmitter.**
  - **The smart key is near a mobile two way radio system or a mobile phone.**
  - **Another vehicle's smart key is being operated close to your vehicle.**
- **Smart liftgate detecting area may change when:**
  - **The vehicle is parked on an incline or slope.**
  - **One side of the vehicle is raised or lowered relative to the opposite side.**

## FUEL FILLER DOOR

### Opening the Fuel Filler Door



B0164KO01

1. Turn the engine off.
2. Ensure the driver's door is unlocked.
3. Push the fuel filler door near the 3 o'clock position.



B0164EU01

4. Pull the fuel filler door ① outward to access the fuel tank cap.
5. To remove the fuel tank cap ②, turn it counterclockwise. You may hear a hissing noise as the pressure inside the tank equalizes.
6. Place the cap on the fuel filler door.

### **i** Information

If the fuel filler door does not open because ice has formed around it, tap lightly or push on the door to break the ice and release the door. Do not pry on the door. If necessary, spray around the door with an approved deicer fluid (do not use radiator antifreeze) or move the vehicle to a warm place and allow the ice to melt.

### Closing the Fuel Filler Door

1. To install the fuel tank cap, turn it clockwise until it “clicks” one time.
2. Close the fuel filler door until it is latched securely.

### **i** Information

The fuel filler door will not close if the driver's door is locked. If you lock the driver's door while fueling, unlock it before closing the fuel filler door.

### **!** WARNING

Gasoline fuel is highly flammable and explosive. Failure to follow these guidelines may result in **SERIOUS INJURY** or **DEATH**:

- Read and follow all warnings posted at the gas station.
- Before refueling, note the location of the Emergency Gasoline Fuel Shut-Off, if available, at the gas station.
- Before touching the fuel nozzle, you should eliminate the potential build-up of static electricity by touching a metal part of the vehicle, a safe distance away from the fuel filler neck, nozzle, or other gas source, with your bare hand.
- Do not use mobile phones while refueling. Electric current and/or electronic interference from cellular phones can potentially ignite fuel vapors and cause a fire.

- Do not get back into a vehicle once you have begun refueling. You can generate a buildup of static electricity by touching, rubbing or sliding against any item or fabric capable of producing static electricity. Static electricity discharge can ignite fuel vapors causing a fire. If you must re-enter the vehicle, you should once again eliminate potentially dangerous static electricity discharge by touching a metal part of the vehicle, away from the fuel filler neck, nozzle or other gasoline source, with your bare hand.
- When using an approved portable fuel container, be sure to place the container on the ground prior to refueling. Static electricity discharge from the container can ignite fuel vapors causing a fire.  
Once refueling has begun, contact between your bare hand and the vehicle should be maintained until the filling is complete.
- Use only approved portable plastic fuel containers designed to carry and store gasoline.
- When refueling, always shift the gear to the P (Park) position, set the parking brake, and place the ignition switch to the LOCK/OFF position. Sparks produced by electrical components related to the engine can ignite fuel vapors causing a fire.
- Do not use matches or a lighter and do not smoke or leave a lit cigarette in your vehicle while at a gas station, especially during refueling.
- Do not over-fill or top-off your vehicle tank, which can cause gasoline spillage.
- If a fire breaks out during refueling, leave the vicinity of the vehicle, and immediately contact the manager of the gas station and then contact the local fire department. Follow any safety instructions they provide.
- If pressurized fuel sprays out, it can cover your clothes or skin and thus subject you to the risk of fire and burns. Always remove the fuel cap carefully and slowly. If the cap is venting fuel or if you hear a hissing sound, wait until the condition stops before completely removing the cap.
- Always check that the fuel cap is installed securely to prevent fuel spillage in the event of an accident.

### Information

Make sure to refuel your vehicle according to the “Fuel Requirements” section in suggested in chapter 1.

### **NOTICE**

- Do not spill fuel on the exterior surfaces of the vehicle. Any type of fuel spilled on painted surfaces may damage the paint.
- If the fuel filler cap requires replacement, use only a genuine HYUNDAI cap or the equivalent specified for your vehicle. An incorrect fuel filler cap can result in a serious malfunction of the fuel system or emission control system.

## HEAD-UP DISPLAY (HUD) (IF EQUIPPED)

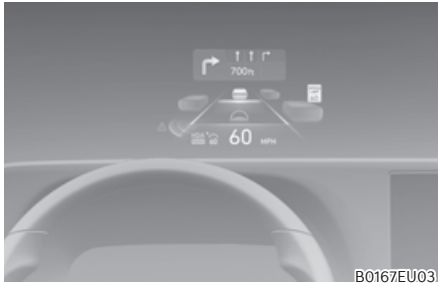

B0167EU03

The Head-Up Display is an optional feature that allows the driver to view information projected onto a transparent screen while still keeping your eyes on the road ahead while driving.

### Head-Up Display Settings

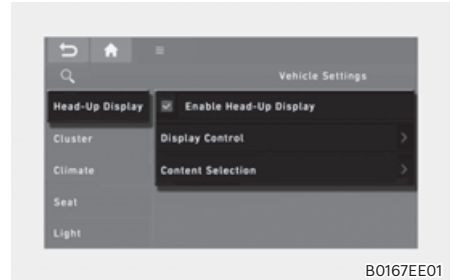

B0167EE01

- Head-up display can be enabled from in the infotainment system. Select:
  - Setup → Vehicle → Head-Up Display → Enable Head-Up Display
- After turning on the head-up display, you can change the settings of 'Display Control' and 'Content Selection' of the Head-Up Display.

### **i** Information

**The infotainment system may change after software updates. For more information, refer to the user's manual provided in the infotainment system and the quick reference guide.**



## Head-Up Display Information

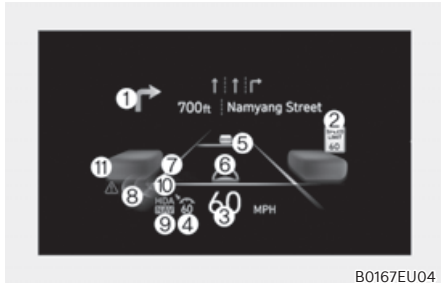

- ① Turn by Turn (TBT) navigation
- ② Traffic sign
- ③ Speedometer
- ④ SCC set speed
- ⑤ SCC vehicle distance
- ⑥ Lane Following Assist
- ⑦ Lane Safety
- ⑧ Blind-Spot Safety
- ⑨ Highway Auto Speed Change
- ⑩ Highway Driving Assist
- ⑪ Surrounding vehicles

## Precautions While Using the Head-Up Display

- It may sometimes be difficult to read information on the Head-Up Display in the following situations.
  - The driver is improperly positioned in the driver's seat
  - The driver wears polarizing-filter sunglasses
  - An object is located above the Head-Up Display cover
  - The vehicle is driven on a wet road
  - Any improper lighting accessory is installed inside the vehicle, or there is incoming light from outside of the vehicle
  - The driver wears glasses
  - The driver wears contact lenses

When it is difficult to read the Head-Up Display information, adjust the image height or brightness level from the Settings menu in the infotainment system screen.

- For your safety, make sure to stop the vehicle before adjusting the settings.
- Do not tint the front windshield glass or add other types of metallic coating. Otherwise, the Head-Up Display image may be invisible.
- Do not place any accessories on the crash pad or attach any objects on the windshield glass.
- When replacing the front windshield glass, replace it with a windshield glass designed for Head-Up Display operation. Otherwise, duplicated images may be displayed on the windshield glass.



## WARNING

The warning information of Blind-Spot Safety on the Head-Up Display are supplemental. Do not solely depend on them to change lanes. Always take a look around before changing lanes.



## Information

Head-up Display includes GPL, LGPL, MPL and other open source license softwares. All license notices including related source code are provided at <http://www.mobis.co.kr/opensource/list.do>.

If the driver requests on-board software open source code via MOBIS\_OSSrequest@mobis.co.kr within 3 years after buying this product, a CD-ROM or other storage device will be sent with the minimum cost covering storage device cost and delivery cost.

## EXTERIOR LIGHTS

### Lighting Control

To operate the lights, turn the knob at the end of the control lever to one of the following positions:

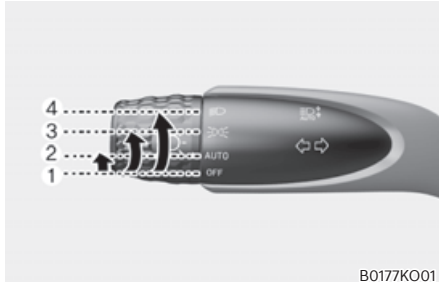

B0177KO01

- ① OFF
- ② AUTO headlight
- ③ Position lamp
- ④ Headlight

### Daytime Running Light (DRL)

The Daytime Running Lights (DRL) can make it easier for others to see the front of your vehicle during the day, especially after dawn and before sunset. The Daytime Running Lights (DRL) should be illuminated whenever you are driving during daylight hours. The DRL system will be ON when the headlight switch is in the OFF or the AUTO position (when daylight is detected) and the Electronic Parking Brake (EPB) is released.

The DRL system will turn off when:

- The headlights are ON.
- The parking brake is applied.
- The vehicle is turned off.
- The parking brake is engaged.

### AUTO headlight

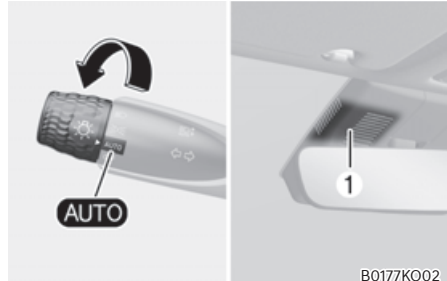

B0177KO02

The position lamp and headlight will be turned ON or OFF automatically depending on the amount of daylight as measured by the ambient light sensor ① at the upper end of the windshield glass.

Even with the AUTO headlight feature in operation, it is recommended to manually turn ON the headlights when driving at night or in a fog, driving in the rain, or when you enter dark areas, such as tunnels and parking facilities.

### NOTICE

- **Do not cover or spill anything on the sensor ① located at the upper end of the windshield glass.**
- **Do not clean the sensor using a window cleaner, the cleanser may leave a light film which could interfere with sensor operation.**
- **If your vehicle window tint or other types of metallic coating on the front windshield, the AUTO headlight system may not work properly.**

### Position lamp (☞☞)

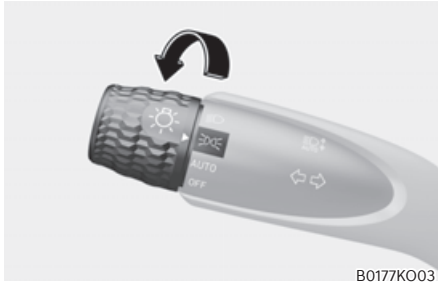

B0177K003

The position lamp, license plate lamp and instrument panel lamp are turned ON.

### Headlight (☞☞)



B0177K004

The headlight, position lamp, license plate lamp and instrument panel lamp are turned ON.

### **i** Information

The ignition switch must be in the ON position to turn on the headlight.

### High Beam Operation

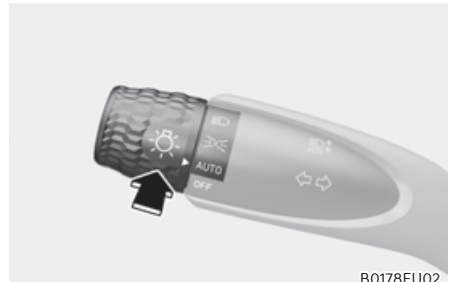

B0178EU02

To turn on the high beam headlight, push the lever away from you. The lever will return to its original position.

The high beam indicator will light when the headlight high beams are switched on.

To turn off the high beam headlight, pull the lever towards you. The low beams will turn on.

### **!** WARNING

**Do not use high beam when there are other vehicles approaching you. Using high beam could obstruct the other driver's vision.**

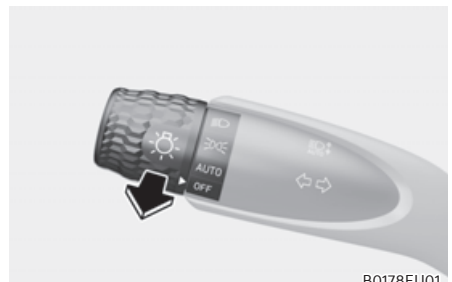

B0178EU01

To flash the high beam headlight, pull the lever towards you, then release the lever. The high beams will remain ON as long as you hold the lever towards you.

## Turn Signals and Lane Change Signals

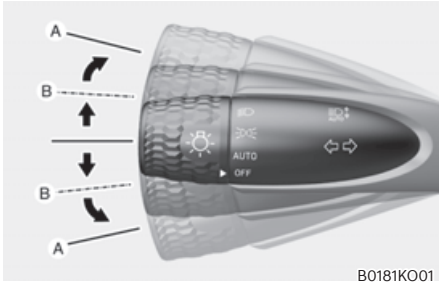

To signal a turn, push down on the lever for a left turn or up for a right turn in position (A).

If an indicator stays on and does not flash or if it flashes abnormally, one of the turn signal bulbs may be burned out and will require replacement.

### **One touch turn signal**

To use One Touch Turn Signal push the turn signal lever up or down to position (B) and then release it.

The lane change signals will blink 3, 5 or 7 times.

You can enable the One Touch Turn Signal function or choose the number of blinking from the Settings menu in the infotainment system. Select:

- Setup → Vehicle → Lights → One Touch Turn Signal → 3 flashes/5 flashes/7 flashes Off

### **i Information**

**The infotainment system may change after software updates. For more information, refer to the user's manual provided in the infotainment system and the quick reference guide.**

## Battery Saver Function

The purpose of this feature is to help prevent the battery from being discharged. The system automatically turns off the position lamp when the driver turns the vehicle off and opens the driver-side door.

With this feature, the position lamps will turn off automatically if the driver parks on the side of road at night.

However, the position lamps stay ON even when the driver-side door is opened if the headlight switch is turned to the position lamp OFF or AUTO (if equipped) position after the engine is turned off.

If necessary, to keep the lamps on turn the position lamps OFF and ON again using the headlight switch on the steering column after the engine is turned off.

## Headlight Delay Function

If the ignition switch is in the ACC position or the LOCK/OFF position with the headlights ON, the headlights (and/or position lamps) remain on for about 5 minutes. However, if the driver's door is opened and closed, the headlights are turned off after 15 seconds. Also, with the vehicle off if the driver's door is opened and closed, the headlights (and/or position lamps) are turned off after 15 seconds.

The headlights (and/or position lamps) can be turned off by pressing the lock button on the smart key twice or turning the headlight switch to the OFF or AUTO position.

You can enable the headlight delay function from the Settings menu in the infotainment system. Select:

- Setup → Vehicle → Lights → Headlight Delay

### NOTICE

**If the driver exits the vehicle through another door besides the driver door, the battery saver function does not operate and the headlight delay function does not turn OFF automatically.**

**This may cause the battery to discharge. To avoid battery discharge, turn OFF the headlights manually from the headlight switch before exiting the vehicle.**

### Information

**The infotainment system may change after software updates. For more information, refer to the user's manual provided in the infotainment system and the quick reference guide.**

## HIGH BEAM ASSIST (HBA)

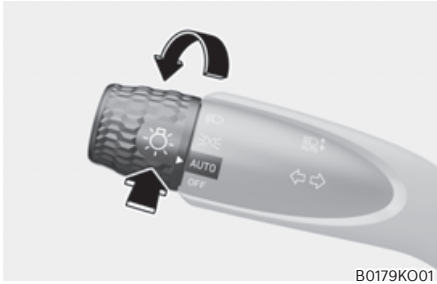

High Beam Assist will automatically switch between high beam and low beam depending on the detected brightness from the lamps of oncoming vehicles or vehicles in front.

### Detecting sensor

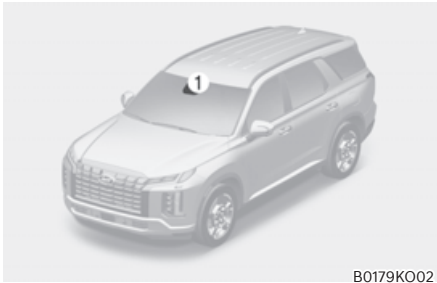

①: front view camera

The front view camera is used as a detecting sensor to detect ambient light and brightness while driving.

Refer to the picture above for the detailed location of the detecting sensor.

### NOTICE

- Always keep the front view camera in good condition to maintain optimal performance of High Beam Assist.
- For more details on the precautions of the front view camera, refer to “Forward Collision-Avoidance Assist (FCA)” section in chapter 7.

## High Beam Assist Settings

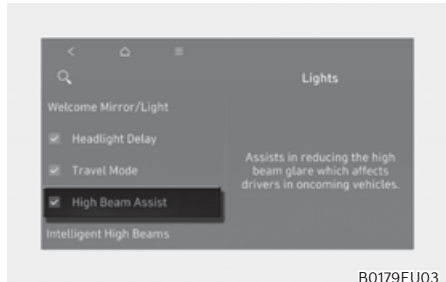

With the ignition switch or the Engine Start/Stop button in the ON position, select 'Lights → High Beam Assist' from the Settings menu to turn on High Beam Assist and deselect to turn off the function.



### WARNING

**For your safety, change the Settings after parking the vehicle at a safe location.**

## High Beam Assist Operation

### *Display and control*

- After selecting 'High Beam Assist' in the Settings menu, High Beam Assist will operate by following the procedure below.
  - Place the headlight switch in the AUTO position and push the headlight lever towards the instrument cluster. The High Beam Assist (HBA) indicator light will illuminate on the cluster and High Beam Assist will be enabled.
  - When High Beam Assist is enabled, high beam will turn on when vehicle speed is above 25 mph (40 km/h). When vehicle speed is below 15 mph (25 km/h), high beam will turn off.
  - The High Beam (HBA) indicator light will illuminate on the cluster when high beam is on.
- When High Beam Assist is operating, if the headlight lever or switch is used, High Beam Assist operates as follow:
  - If the headlight lever is pulled towards you when the high beam is off, the high beam will turn on without High Beam Assist canceled. When you let go of the headlight lever, the lever will move to the middle and the high beam will turn off.
  - If the headlight lever is pulled towards you when the high beam is on by High Beam Assist, low beam will be on and High Beam Assist will turn off.
  - If the headlight switch is placed from AUTO to another position (headlight/position/off), High Beam Assist will turn off and the corresponding lamp will turn on.
- When High Beam Assist is operating, high beam switches to low beam if any of the following conditions occur:
  - When the headlight of an oncoming vehicle is detected.
  - When the tail lamp of a vehicle in front is detected.
  - When the headlight or tail lamp of a motorcycle or a bicycle is detected.
  - When the surrounding ambient light is bright enough that high beams are not required.
  - When streetlights or other lights are detected.

### **i** Information

**The images and colors in the cluster may differ depending on the cluster type or theme selected from the cluster.**



## High Beam Assist Malfunction and Limitations

### High Beam Assist malfunction

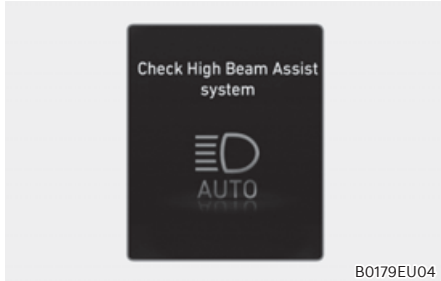

When High Beam Assist is not working properly, the 'Check High Beam Assist (HBA) system' warning message will appear and  warning light will illuminate on the cluster. Have the function be inspected by an authorized HYUNDAI dealer.

### Limitations of High Beam Assist

- Light from an oncoming or front vehicle is not detected because of lamp damage, or because it is hidden from sight, etc.
- Headlight of an oncoming or front vehicle is covered with dust, snow or water.
- An oncoming or front vehicle's headlights are off, but the fog lamps are on, etc.
- There is a lamp that has a similar shape as a vehicle's lamp.
- Headlights have been damaged or not repaired properly.
- Headlights are not aimed properly.
- Driving on a narrow-curved road, curved road, rough road, uphill or downhill.
- Vehicle in front is partially visible on a crossroad or curved road.

- There is a traffic light, reflecting sign, flashing sign or mirror ahead.
- There is a temporary reflector or flash ahead (construction area).
- The road conditions are bad such as being wet, iced or covered with snow.
- A vehicle suddenly appears from a curve.
- The vehicle is tilted from a flat tire or is being towed.
- Light from an oncoming or front vehicle is not detected due to obstacles in the air such as exhaust fume, smoke, fog, snow, or water spray or blizzard on the road, or fogging in the lamp, etc.

### Information

For more details on the limitations of the Front View Camera, refer to "Forward Collision-Avoidance Assist (FCA)" section in chapter 7.

### WARNING

- **At times, High Beam Assist may not work properly. High Beam Assist is for your convenience only. It is the responsibility of the driver for safe driving practices and always check the road conditions for your safety.**
- **When High Beam Assist does not operate normally, change the headlight position manually between high beam and low beam.**
- **High Beam Assist may not operate for 15 seconds after the vehicle is started, or the front view camera is initialized.**

## INTERIOR LIGHTS



### WARNING

Do not use the interior lights when driving in the dark. The interior lights may obscure your view and cause an accident.

### NOTICE

Do not use the interior lights for extended periods when the vehicle is turned off or the battery will discharge.

### Interior Lamp AUTO Off

The interior lamps will automatically go off approximately 20 minutes after the vehicle is turned off and the doors are closed. If a door is opened, the lamp will go off 25 minutes after the vehicle is turned off. If the doors are locked by the smart key and the vehicle enters the armed stage of the theft alarm system, the lamps will go off five seconds later.

## Front Lamps



B0903EU03

### Front map lamp ( ):

Touch either icons to turn the map lamp on or off. This light produces a spot beam for convenient use as a map lamp at night or as a personal lamp for the driver and the front passenger.

### Door lamp ( ):

The front or rear room lamps come on when the front or rear doors are opened. When doors are unlocked by the smart key, the front and rear lamps come on for approximately 30 seconds as long as any door is not opened. The front and rear room lamps go out gradually after approximately 30 seconds when the door is closed. However, if the ignition switch or Engine Start/Stop button is in the ON position or all doors are locked, the front and rear lamps will turn off. If a door is opened with the ignition switch in the ACC position or the LOCK/OFF position, the front and rear lamps will stay on for about 5 minutes.

### Room lamp ( ):

Press the button to turn ON the room lamp for the front and rear seats.

## Rear Lamps

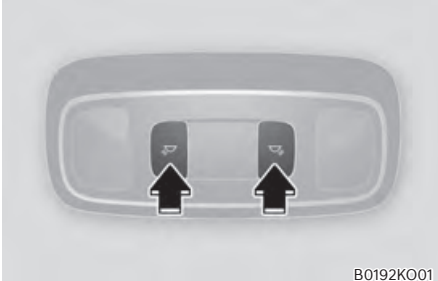

B0192K001

-  :  
Touch the icon to turn either lamp on or off.

## Vanity Mirror Lamp



B0194K004

Opening the lid of the vanity mirror will automatically turn on the mirror lamp.

## Glove Box Lamp

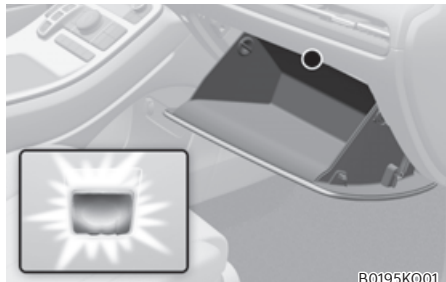

B0195K001

The glove box lamp turns on when the glove box is opened.  
If the glove box is not closed, the lamp will turn off after 20 minutes.

### **NOTICE**

**To prevent unnecessary charging system drain, close the glove box securely after using the glove box.**

### Door Courtesy Lamp (if equipped)

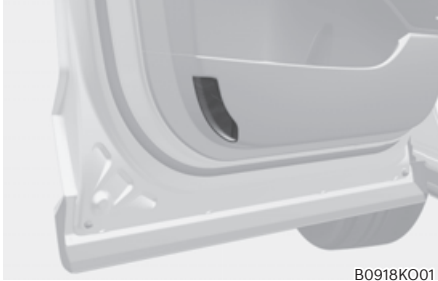

B0918KO01

The lamp turns on when a door is open and turns off when the door is closed.

### Luggage Compartment Lamp

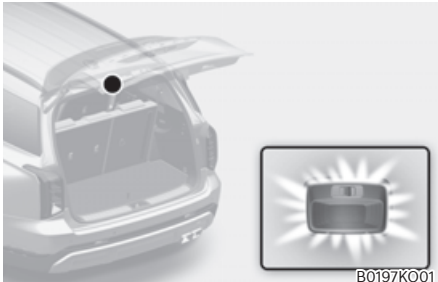

B0197KO01

- ON (☀️):  
The luggage compartment lamp stays on at all times.
- DOOR (🚗):  
The luggage compartment lamp comes on when the liftgate is opened.
- OFF (☾):  
The luggage compartment lamp is off.

### Puddle Lamp Welcome light

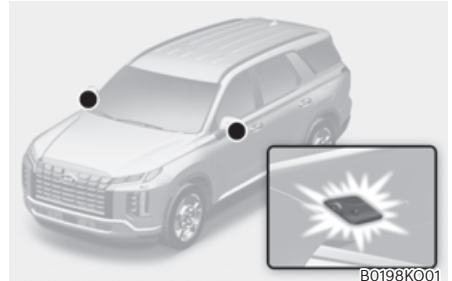

B0198KO01

When all doors (and liftgate) are closed and locked, the puddle lamp will turn on for 15 seconds if the door is unlocked by the smart key or when you put your hand in the outside door handle with the smart key in possession.

For more details, refer to “Welcome System” in this chapter.

### Escort light

When the ignition switch is in the LOCK/OFF position and the driver's door is opened, the puddle lamp will turn on for 30 seconds. If the driver's door is closed within the 30 second period, the puddle lamp will turn off after 15 seconds. If the driver's door is closed and locked, the puddle lamp will turn off immediately.

The Puddle Lamp Escort Light will turn on only the first time the driver's door is opened after the engine is turned off.

### Welcome System

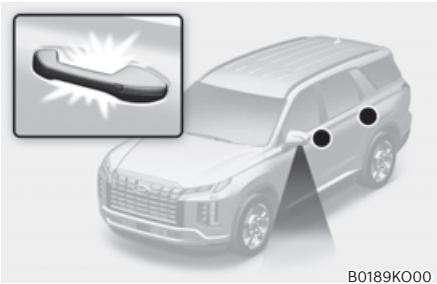

Welcome system helps keep the driver visible by turning on vehicle lights when the driver approaches the vehicle.

### ***Puddle lamp and door handle lamp***

When all the doors (and liftgate) are closed and locked, the puddle lamp and door handle lamp will turn on for approximately 15 seconds if:

When all the doors (and liftgate) are closed and locked, the puddle light and door handle light turn on for about 15 seconds if:

- Convenience → Welcome Mirror/Light → On door unlock is selected from the Setting menu in the infotainment system,
  - The door unlock button is pressed on the smart key.
  - The button type of the outside door handle is pressed with the smart key in possession.
  - The touch sensor type of the outside door handle is touched with the smart key in possession.
  - You put your hand in the outside door handle with the smart key in possession.
- When the smart key is detected, if both Convenience → Welcome Mirror/Light → On door unlock and Convenience → Welcome Mirror/Light → On driver approach are selected.

You can activate or deactivate the Welcome Light function from the Setting menu in the infotainment system.

### **Headlight and position lamp**

When the light switch is ON, and all the doors (and liftgate) are closed and locked, the headlight and position lamp will turn on for approximately 15 seconds if the door unlock button is pressed on the smart key. Note that if the light switch is in the AUTO position, the headlight and position light will turn on only when it is dark outside.

Select 'Setup → Lights → Headlight Delay' from the Settings menu to turn on this function.

### **Interior lamp**

When the interior lamp switch is in the  position and all doors (and liftgate) are closed and locked, the room lamp will come on for 30 seconds when:

- The door unlock button is pressed on the remote key or smart key.
- The button type of the outside door handle is pressed with the smart key in possession.
- The touch sensor type of the outside door handle is touched with the smart key in possession.
- You put your hand in the outside door handle with the smart key in possession.

If you press the door lock or unlock button on the smart key, the lights turn off immediately.

### **Information**

**The infotainment system may change after software updates. For more information, refer to the user's manual provided in the infotainment system and the quick reference guide.**

## WIPERS AND WASHERS

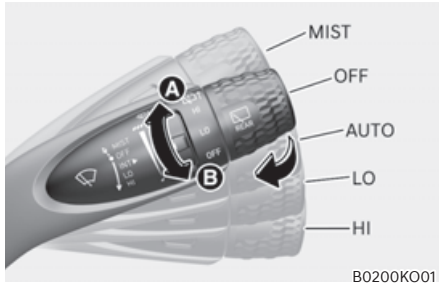

### Front Windshield Wipers

Operates as follows when the ignition switch or Engine Start/Stop button is in the ON position.

**MIST:** For a single wiping cycle, push the lever upward and release. The wipers will operate continuously if the lever is held in this position.

**OFF:** Wiper is not in operation.

**AUTO (if equipped):** The rain sensor located on the upper end of the windshield glass senses the amount of rainfall and controls the wiping cycle for the proper interval. The more it rains, the faster the wiper operates. When the rain stops, the wiper stops. To vary the speed setting, turn the speed control knob.

**LO:** The wiper runs at a lower speed.

**HI:** The wiper runs at a higher speed.

### **i** Information

**If there is heavy accumulation of snow or ice on the windshield, defrost the windshield for about 10 minutes, or until the snow and/or ice is removed before using the windshield wipers to ensure proper operation.**

**If you do not remove the snow and/or ice before using the wiper and washer, it may damage the wiper and washer system.**

### *AUTO wiper control (if equipped)*

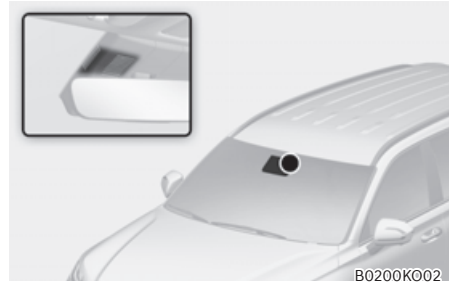

The rain sensor located on the upper end of the windshield glass senses the amount of rainfall and controls the wiping cycle for the proper interval.

The wiper operation time will be automatically controlled depends on rainfall.

When the rain stops, the wiper stops.

To vary the sensitivity setting, turn the sensitivity control knob.

If the wiper switch is set in AUTO mode when the ignition switch is in the ON position, the wiper will operate once to perform a self-check of the system. Set the wiper to the OFF position when the wiper is not in use.

## WARNING

To avoid personal injury from the windshield wipers, when the engine is running and the windshield wiper switch is placed in the AUTO mode:

- Do not touch the upper end of the windshield glass facing the rain sensor.
- Do not wipe the upper end of the windshield glass with a damp or wet cloth.
- Do not put pressure on the windshield glass.

## **NOTICE**

- When washing the vehicle, set the wiper switch in the OFF position to stop the auto wiper operation. The wiper may operate and be damaged if the switch is set in the AUTO mode while washing the vehicle.
- Do not remove the sensor cover located on the upper end of the passenger side windshield glass. Damage to system components could occur and may not be covered by your vehicle warranty.
- Because of using a photo sensor, temporary malfunction could occur according to sudden ambient light change made by stone and dust while driving.

## Front Windshield Washers



B0201KO01

In the OFF position, pull the lever gently toward you to spray washer fluid on the windshield and to run the wipers 1-3 cycles. The spray and wiper operation will continue until you release the lever. If the washer does not work, you may need to add washer fluid to the washer fluid reservoir.



### **Recirculating air when washer fluids used**

When washer fluid is used, in order to reduce any objectionable scent of the washer fluid from entering the cabin, recirculation mode and air conditioning are automatically activated depending on the outside temperature.

- When the air intake control button is pressed while fresh mode is selected, air intake control will switch to recirculation mode.
- When windshield lever is used while recirculation mode is selected, air intake control will switch to fresh mode.
- The function may not work in some conditions such as cold weather or engine off.

For more details, refer to “Climate Control Additional Features” section in this chapter.



### **WARNING**

When the outside temperature is below freezing, **ALWAYS** warm the windshield using the defroster to help prevent the washer fluid from freezing on the windshield and obscuring your vision which could result in an accident and serious injury or death.

### **NOTICE**

- To prevent possible damage to the washer pump, do not operate the washer when the fluid reservoir is empty.
- To prevent possible damage to the wipers or windshield, do not operate the wipers when the windshield is dry.
- To prevent damage to the wiper arms and other components, do not attempt to move the wipers manually.
- To prevent possible damage to the wipers and washer system, use anti-freezing washer fluids in the winter season or cold weather.

## Rear Window Wiper and Washer



B0200K003

The rear window wiper and washer switch is located at the end of the wiper and washer switch lever. Turn the switch to the desired position to operate the rear wiper and washer.

HI: High wiper speed

LO: Low wiper speed

OFF: Off

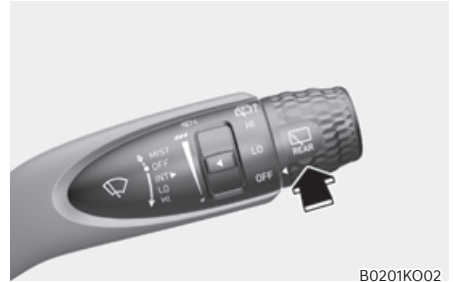

B0201K002

Push the lever away from you to spray rear washer fluid and to run the rear wipers 1–3 cycles. The spray and wiper operation will continue until you release the lever.

### **Auto rear wiper**

The rear wiper will operate while the vehicle is in reverse with the front wiper ON by selecting the function from the Settings menu in the infotainment system screen. Select:

- Setup → Vehicle → Convenience → Auto Rear Wiper (in R)

### **i Information**

**The infotainment system may change after software updates. For more information, refer to the user's manual provided in the infotainment system and the quick reference guide.**

## MANUAL CLIMATE CONTROL SYSTEM (IF EQUIPPED)

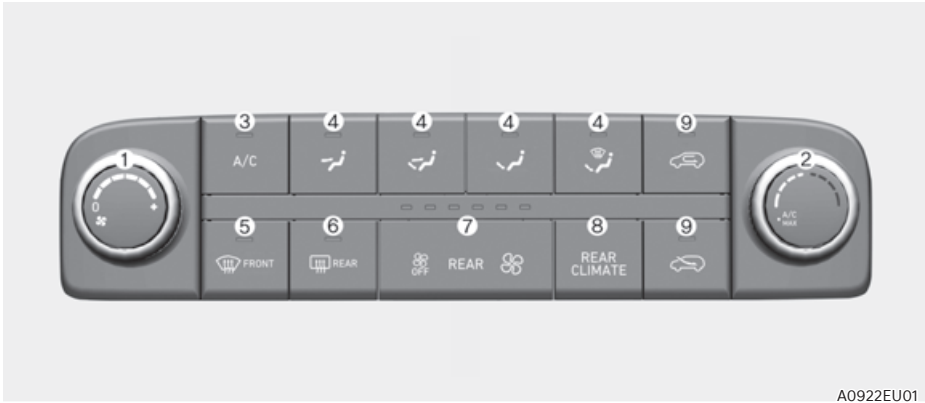



A0922EU01

### Front

- ① Fan speed control knob
- ② Temperature control knob
- ③ Air conditioning button
- ④ Mode selection button
- ⑤ Front windshield defroster button
- ⑥ Rear window defroster button
- ⑦ Rear fan speed control button
- ⑧ Rear climate control button
- ⑨ Air intake control button

## Heating and Air Conditioning

1. Start the engine.
2. Set the mode to the desired position.  
To improve the effectiveness of heating and cooling, select the mode according to the following:
  - Heating: 
  - Cooling: 
3. Set the temperature control to the desired position.
4. Set the air intake control to Fresh mode or Recirculation mode position.
5. Set the fan speed control to the desired speed.

6. If air conditioning is desired, turn the air conditioning system on.

When starting the vehicle in cold weather a more efficient way to heat the passenger compartment is to do the following.

- Turn off or lower the blower, right after starting the engine.
- Engine temperature is still low and the air flow from the heater is still cold.
- After a few minutes of engine warm up, turn on or set the fan to a higher level and adjust the temperature setting to hot.

### Mode selection



A0204K002

The mode selection button controls the direction of the air flow through the ventilation system. Air can be directed to the floor, dashboard outlets, or windshield. Five symbols are used to represent Face, Bi-Level, Floor, Floor-Defrost and Defrost air position.

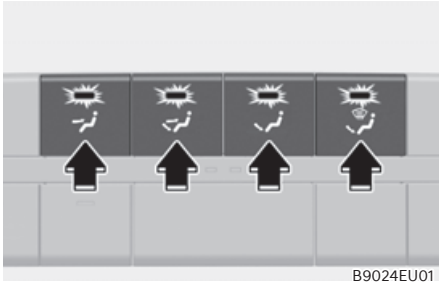

### Face-Level (B, D)

Air flow is directed toward the upper body and face. Additionally, each outlet can be controlled to direct the air discharged from the outlet.

### Bi-Level (B, D)

Air flow is directed towards the face and the floor.

### Floor-Level (A, C, D, E)

Most of the air flow is directed to the floor, with a small amount of the air being directed to the windshield and side window defrosters.

### Floor & Defrost (A, C, D, E)

Most of the air flow is directed to the floor and the windshield with a small amount directed to the side window defrosters.

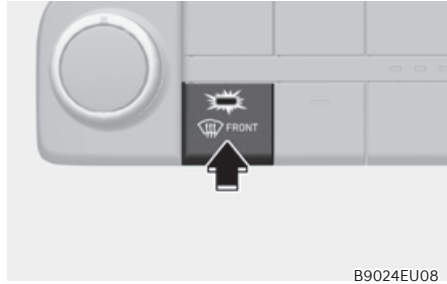

### Defrost-Level (A, D)

Most of the air flow is directed to the windshield with a small amount of air directed to the side window defrosters.



### MAX A/C-Level (B, D)

The MAX A/C mode is used to cool the inside of the vehicle faster. Air flow is directed toward the upper body and face.

In this mode, the A/C button and the Recirculation mode button will be automatically selected. Turn the fan speed mode to adjust.

After the interior cabin has cooled sufficiently, move the temperature knob away from the MAX A/C setting and adjust the knob to the desired position. If you wish to continue using A/C ON, make sure the A/C button indicator is illuminated.

### ***Instrument panel vents***

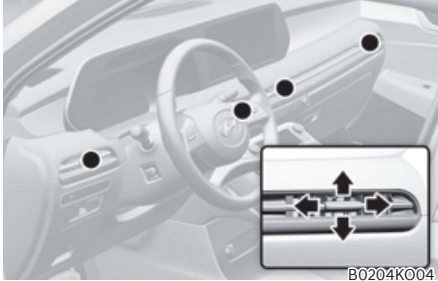

The instrument panel vent air flow can be directed up/down or left/right using the vent adjustment lever.

The outlet vents can be opened or closed separately using the vent control lever.

If you move the vent control lever away from the passenger, the outlet vents can be closed.

### ***Temperature control***



The temperature will increase by turning the knob to the right.

The temperature will decrease by turning the knob to the left.

### ***Air intake control***



The air intake control button is used to select either Fresh mode (outside air) or Recirculation mode (cabin air).

### Recirculation mode



When Recirculation mode is selected, air from the passenger compartment will be recirculated through the system and heated or cooled according to the function selected.

### Fresh mode



When Fresh mode is selected, air enters the vehicle from outside and is heated or cooled according to the function selected.

### Information

Operating the system primarily in Fresh mode is recommended. Use Recirculation mode temporarily only when needed.

Prolonged operation of the heater in Recirculation mode and without the A/C ON can cause fogging of the windshield.

In addition, prolonged use of the A/C ON in Recirculation mode may result in excessively dry, dehumidified air in the cabin and may promote formation of musty vent odor due to stagnant air.

### WARNING

- Continued use of the climate control system operation in Recirculation mode for a prolonged period of time may cause drowsiness to the occupants in the cabin. This may lead to loss of vehicle control which may lead to an accident.
- Continued use of the climate control system operation in Recirculation mode with the A/C OFF may allow humidity to increase inside the cabin. This may cause condensation to accumulate on the windshield and obscure visibility.
- Do not sleep in your vehicle or remain parked in your vehicle with the windows up and either the heater or the air conditioning ON for prolonged periods of time. Doing so may increase the levels of carbon dioxide in the cabin which may lead to serious injury or death.

### Fan speed control

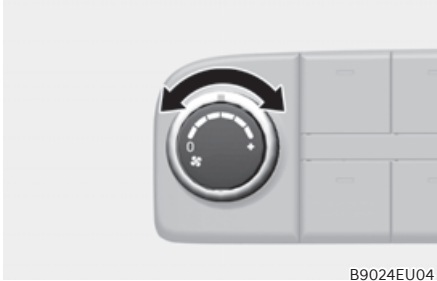

B9024EU04

Turn the knob to the right to increase the fan speed and airflow. Turn the knob to the left to decrease fan speed and airflow.

Setting the fan speed control knob to the "0" position turns off the fan.

#### **NOTICE**

**Operating the fan speed when the ignition switch is in the ON position could cause the battery to discharge. Operate the fan speed when the engine is running.**

### Air conditioning

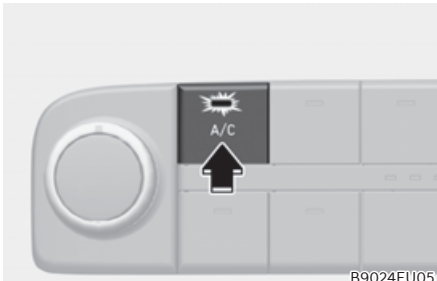

B9024EU05

Press the A/C button to turn the system on (indicator light will illuminate) and off.

### Rear climate control button



B9024EU06

If you press the rear climate control button, rear passengers can control the rear climate system.

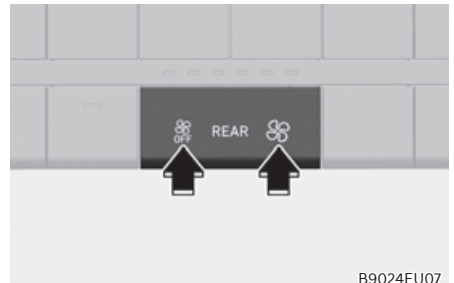

B9024EU07

Press the rear fan speed control button to increase or decrease the fan speed and air flow.



## Rear climate control

■ 2nd row air conditioning control



A0923EU01/A0923EU01/A0923EU03

- ① OFF button
- ② Mode selection button
- ③ Temperature control button
- ④ Fan speed control button

If you press the rear climate control button of the front climate control system, rear passengers can control the rear climate system by using the rear climate control system.

### Fan speed control



B9024EU06

1. Press the rear climate control button of the front climate control system.

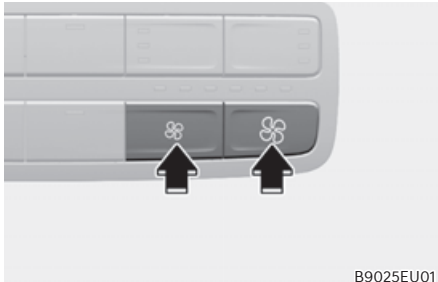

B9025EU01

2. The fan speed can be set to the desired speed by pushing the fan speed control button. The higher the fan speed is, the more air is delivered. Pressing the OFF button turns off the fan.

### Temperature control

1. Press the rear climate control button of the front climate control system.

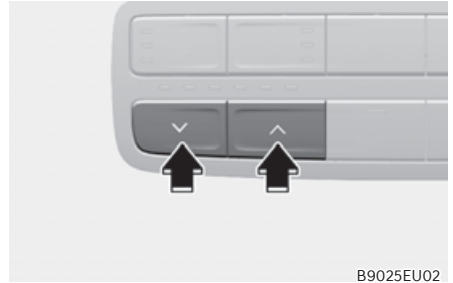

B9025EU02

2. The temperature of delivered air can be set to the desired temperature by pushing the temperature control button. Pressing the off button turns off the fan.

### OFF mode

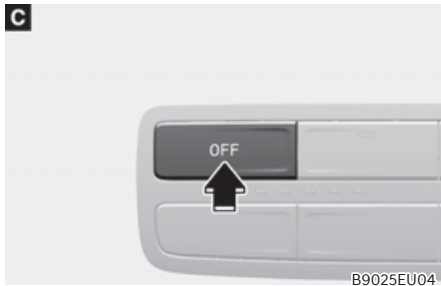
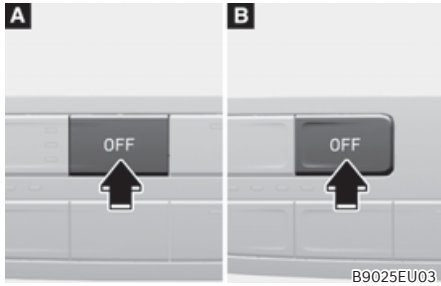

Press the OFF button to turn the rear climate control system off.

### Mode selection

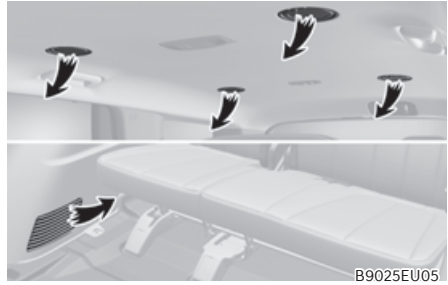

You can select the direction of the air flow through the ventilation system.

You can adjust the front climate control system for heating or cooling to passengers on 2nd row seats. The air flow is directed from the floor.



: Air flow is directed toward the upper body from the rear headliner.



: Air flow is directed toward the upper body and the floor.



: Air flow is directed toward the floor.

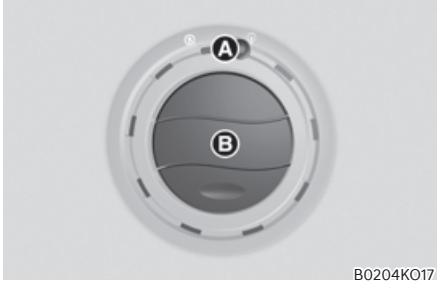

### Rear vents on the headliner



B0204K017

The rear passengers can adjust the direction of air flow from the rear vents on the headliner.

If you operate the rear climate control with rear vents closed, a noise may sound. When operating the rear climate control, open two or more rear vents.

No	Diffusion lever (A)	Direction thumbwheel (B)	Description
1	Open 	Close	The air is delivered widely toward the surroundings of rear passengers. However, the fan speed may be decreased.
2	Open 	Open	The air is delivered widely toward the rear passengers and surrounding of rear passengers.
3	Close 	Open	The air is only delivered toward the rear passengers.



### System Operation

#### Cooling / Ventilation

1. Select the Face Level  mode.
2. Set the air intake control to fresh mode.
3. Set the temperature control to the desired position.
4. Set the fan speed control to the desired speed.

#### Heating

1. Select the Floor Level  mode.
2. Set the air intake control to fresh mode.
3. Set the temperature control to the desired position.
4. Set the fan speed control to the desired speed.
5. If desired, turn the air conditioning ON with the temperature control knob set to heat in order to dehumidify the air before it enters into the cabin.

If the windshield fogs up, select the Floor & Defrost  mode or press the Front Defrost  mode.

#### Operation Tips

- To keep dust or unpleasant fumes from entering the vehicle through the ventilation system, temporarily set the air intake control to recirculation mode. Return the control to fresh mode when the unpleasant air outside has diminished. This will help keep the driver alert and comfortable.
- To help prevent the inside of the windshield from fogging, set the air intake control to fresh mode and fan speed to the desired position, turn on the air conditioning system, and adjust the temperature control to the desired temperature.

### **Air conditioning**

Your HYUNDAI vehicle air conditioning system is filled with R-1234yf refrigerant.

1. Start the engine.
2. Press the air conditioning button.
3. Select the Face Level  mode.
4. Set the air intake control to Recirculation mode temporarily to allow the cabin to cool quickly. When the desired temperature in the cabin is reached, change the air intake control back to Fresh mode.
5. Adjust the fan speed control and temperature control to maintain maximum comfort.

When maximum cooling is desired, set the temperature control to the MAX A/C position, then set the fan speed control to the highest setting.

#### **NOTICE**

**When using the air conditioning system, monitor the engine temperature gauge closely while driving up hills or in heavy traffic when outside temperatures are high. Air conditioning system operation when climbing a steep grade or in high outside ambient temperatures can cause engine overheating.**

**Continue to use the fan, but turn the air conditioning system off if the engine temperature gauge indicates engine overheating.**

### **Air conditioning system operation tips**

- If the vehicle has been parked in direct sunlight during hot weather, open the windows for a short time to let the hot air inside the vehicle escape.
- After sufficient cooling has been achieved, switch back from recirculation mode to fresh mode.
- To help reduce moisture inside of the windows on rainy or humid days, decrease the humidity inside the vehicle by operating the air conditioning system with the windows and sunroof closed.
- Use the air conditioning system every month only for a few minutes to ensure maximum system performance.
- If you operate air conditioner excessively, the difference between the temperature of the outside air and that of the windshield could cause the outer surface of the windshield to fog up, causing loss of visibility. In this case, set the mode selection knob or button to the  position and fan speed control to the lower speed.

## System Maintenance

### Cabin air filter

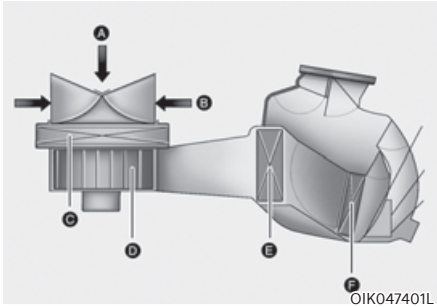

- (A): Outside air, (B): Recirculated air  
(C): Climate control air filter, (D): Blower  
(E): Evaporator core, (F): Heater core

The cabin air filter is installed behind the glove box. It filters the dust or other pollutants that enter the vehicle through the heating and air conditioning system.

Have the cabin air filter replaced by an authorized HYUNDAI dealer according to the maintenance schedule. If the vehicle is being driven in severe conditions such as dusty or rough roads and/or if transporting pets or occupants smoke inside the vehicle, then more frequent cabin air filter inspections and changes are required.

If the air flow rate suddenly decreases, the system should be checked at an authorized HYUNDAI dealer.

### Checking the amount of air conditioner refrigerant and compressor lubricant

When the amount of refrigerant is low, the performance of the air conditioning is reduced. Overfilling also reduces the performance of the air conditioning system.

Therefore, if abnormal operation is found, have the system inspected by an authorized HYUNDAI dealer.

#### NOTICE

**It is important that the correct type and amount of oil and refrigerant is used. Otherwise, damage to the compressor and abnormal system operation may occur. To prevent damage, the air conditioning system in your vehicle should only be serviced by trained and certified technicians.**

#### NOTICE

- The refrigerant system should only be serviced by trained and certified technicians to insure proper and safe operation.
- The refrigerant system should be serviced in a well-ventilated place.
- The air conditioning evaporator (cooling coil) shall never be repaired or replaced with one removed from a used or salvaged vehicle and new replacement MAC evaporators shall be certified (and labeled) as meeting SAE Standard J2842.

## WARNING

Vehicles equipped with R-1234yf



Since the refrigerant is operated at very high pressure, the air conditioning system should only be serviced by trained and certified technicians.

It is important that the correct type and amount of oil and refrigerant are used.

All refrigerants should be reclaimed with proper equipment.

Venting refrigerants directly to the atmosphere is harmful to individuals and environment. Failure to heed these warnings can lead to serious injuries.

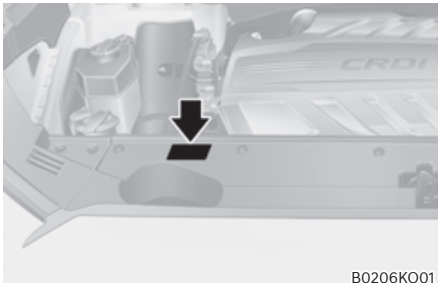

B0206KO01

### Air Conditioning refrigerant label

You can find out which air conditioning refrigerant is applied to your vehicle on the label located in front of engine compartment.

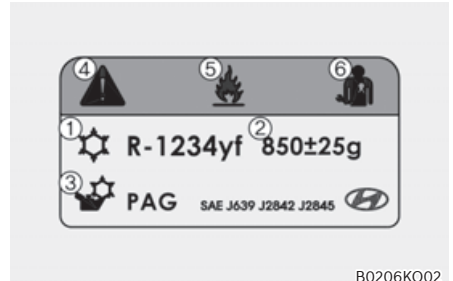

B0206KO02

Each symbol and specification on the air conditioning refrigerant label is represented as below:

- ① Classification of refrigerant
- ② Amount of refrigerant
- ③ Classification of compressor lubricant
- ④ Caution
- ⑤ Flammable refrigerant
- ⑥ To require registered technician to service air conditioning system



## AUTOMATIC CLIMATE CONTROL SYSTEM



A0202EU01/A0202EU02

### Front

- ① Driver's temperature control knob
- ② Passenger's temperature control knob
- ③ AUTO (automatic control) button
- ④ SYNC button
- ⑤ Front windshield defroster button
- ⑥ Air conditioning button
- ⑦ OFF button
- ⑧ Fan speed control button
- ⑧ Mode selection button
- ⑩ Rear climate control button
- ⑪ Air intake control button
- ⑫ Rear window defroster button
- ⑬ Climate control information screen

## Automatic Temperature Control Mode

The Automatic Climate Control System is controlled by setting the desired temperature.

For your convenience and to improve the efficiency of the climate control, use the AUTO button and set the temperature to 72°F (22°C).

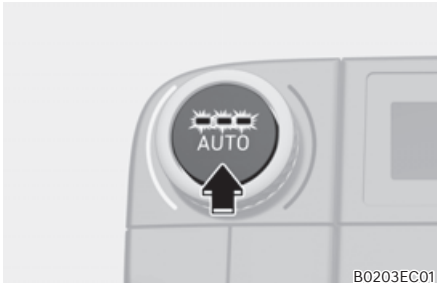

B0203EC01

1. Press the AUTO button .

The modes, fan speeds, air intake and air-conditioning will be controlled automatically by the temperature setting you select.

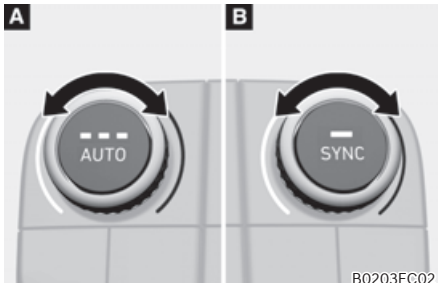

B0203EC02

(A): Driver side, (B): Passenger side

2. To select a different set point, turn the temperature control knob to the desired temperature. If the temperature is set to the lowest setting (Lo), the air conditioning system will operate continuously. After the interior has cooled sufficiently, adjust the knob to a higher temperature set point whenever possible.

To turn the automatic operation off, select any button of the following:

- Mode selection button
- Front windshield defroster button (Press the button one more time to deselect the front windshield defroster function. The 'AUTO' sign will illuminate on the information display once again.)
- Fan speed control button
- A/C button

The selected function will be controlled manually while other functions operate automatically.

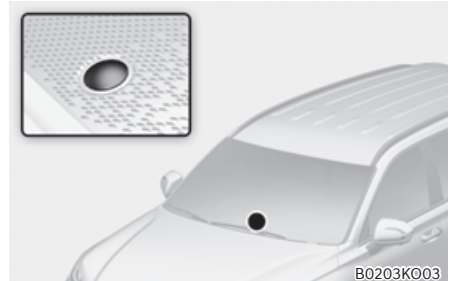

B0203K003

### NOTICE

**Never place anything near the ambient light/solar sensor to ensure better control of the heating and cooling system.**



### Manual Temperature Control Mode

The heating and cooling system can be controlled manually by pushing buttons other than the AUTO button. In this case, the system works sequentially according to the order of buttons selected.

When pressing any button except the AUTO button while using automatic operation, the functions not selected will be controlled automatically.

1. Start the engine.
2. Set the mode to the desired position.

To improve the effectiveness of heating and cooling, select the mode according to the following:

- Heating: 
- Cooling: 

3. Set the temperature control to the desired position.
4. Set the air intake control to Fresh mode.
5. Set the fan speed control to the desired speed.

6. If air conditioning is desired, turn the air conditioning system on.
7. Press the AUTO button to convert to full automatic control of the system.

When starting the vehicle in cold weather using manual temperature control, operate the system in the following method to improve heating.

- Turn off or lower the blower, right after starting the engine.
- Allow the engine to warm up during this time since the air flow from the heater is still cold.
- After a few minutes of engine warm up, turn on or set the fan to a higher level and adjust the temperature setting to hot.

### Mode selection



A0204K002

The mode selection button or icon controls the direction of the air flow through the ventilation system.

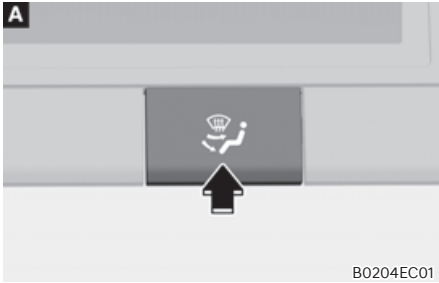

 Floor-Level (A, C, D, E)

Most of the air flow is directed to the floor, with a small amount of the air being directed to the windshield and side window defrosters.

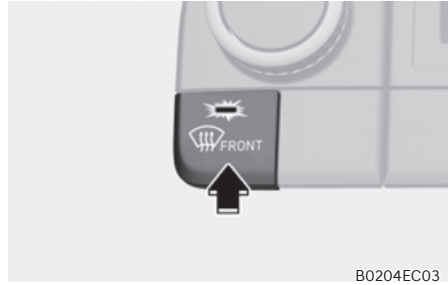
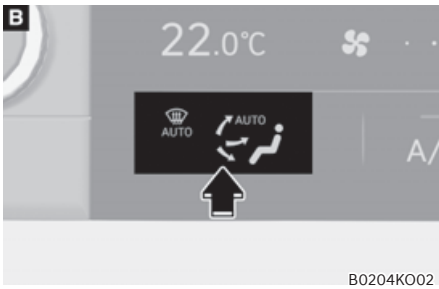

 Defrost-Level (A, D)

Most of the air flow is directed to the windshield with a small amount of air directed to the side window defrosters.

 Face-Level (B, D)

Air flow is directed toward the upper body and face. Additionally, each outlet can be controlled to direct the air discharged from the outlet.

 Bi-Level (B, C, D, E)

Air flow is directed towards the face and the floor.

 Floor & Defrost (A, C, D, E)

Most of the air flow is directed to the floor and the windshield with a small amount directed to the side window defrosters.

**Instrument panel vents**

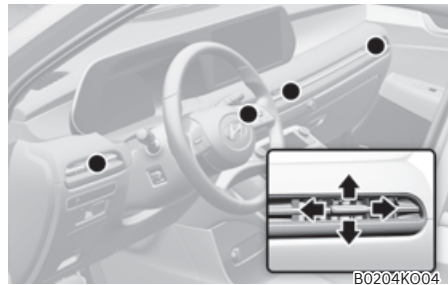

The instrument panel vent air flow can be directed up/down or left/right using the vent adjustment lever.

The outlet vents can be opened or closed separately using the vent control lever. If you move the vent control lever the left end, the outlet vents can be closed.

## Temperature control

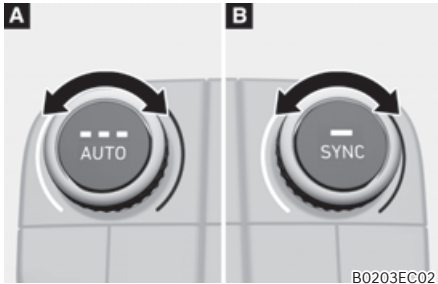

Ⓐ: Driver side, Ⓑ: Passenger side

Turn the knob to the right to increase the temperature. Turn the knob to the left to decrease temperature.

The temperature will increase or decrease by 1°F/0.5°C for each incremental location. When set to the lowest temperature setting, the air conditioning will operate continuously.



### Adjusting the driver and passenger side temperature equally

- Press the “SYNC” button to operate the driver and passenger side temperature equally.

The passenger side temperature will be set to the same temperature as the driver side temperature.

- Turn the driver side temperature control knob. The driver and passenger side temperature will be adjusted equally.

### Adjusting the driver and passenger side temperature individually

Press the “SYNC” button again to operate the driver and passenger side temperature individually. The button indicator will turn off.

### Temperature conversion

If the battery has been discharged or disconnected, the temperature mode display will reset to Fahrenheit.

To change the temperature unit from °F to °C or °C to °F, do one of the following:

- Infotainment system screen Go to 'User Settings → Units → Temperature Unit' or 'Setup → General → Units → Temperature Unit'
- Press the AUTO button for 3 seconds while pressing the OFF button on the climate control unit.

The temperature unit on both the cluster LCD display and climate control screen will change.

### **Air intake control**

The air intake control button is used to select either Fresh mode (outside air) or Recirculation mode (cabin air).

#### **Recirculation mode**



When Recirculation mode is selected, air from the passenger compartment will be recirculated through the system and heated or cooled according to the function selected.

#### **Fresh mode**



When Fresh mode is selected, air enters the vehicle from outside and is heated or cooled according to the function selected.

### ***i* Information**

**Operating the system primarily in Fresh mode is recommended. Use Recirculation mode temporarily only when needed.**

**Prolonged operation of the heater in Recirculation mode and without the A/C ON can cause fogging of the windshield.**

**In addition, prolonged use of the A/C ON in Recirculation mode may result in excessively dry, dehumidified air in the cabin and may promote formation of musty vent odor due to stagnant air.**

### **WARNING**

- **Continued use of the climate control system operation in Recirculation mode for a prolonged period of time may cause drowsiness to the occupants in the cabin. This may lead to loss of vehicle control which may lead to an accident.**
- **Continued use of the climate control system operation in Recirculation mode with the A/C OFF may allow humidity to increase inside the cabin. This may cause condensation to accumulate on the windshield and obscure visibility.**
- **Do not sleep in your vehicle or remain parked in your vehicle with the windows up and either the heater or the air conditioning ON for prolonged periods of time. Doing so may increase the levels of carbon dioxide in the cabin which may lead to serious injury or death.**

### Fan speed control

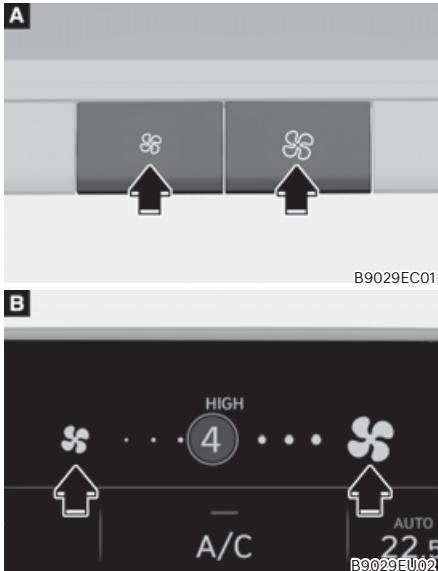

The fan speed can be set as desired by pressing the fan speed control button or icon.

More air is delivered with higher fan speeds.

Pressing the OFF button turns off the fan.

### **i** Information

For better sound quality, fan speed may automatically slow down for a couple of minutes when you activate voice recognition or hands free.

### **NOTICE**

Operating the fan when the ignition switch is in the ON position could cause the battery to discharge. Operate the fan when the engine is running.

### Air conditioning

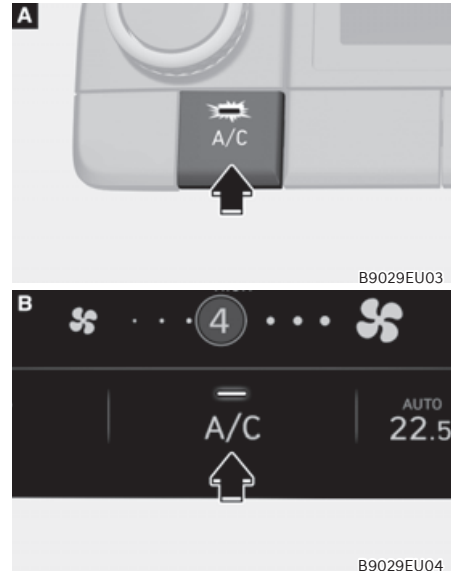

Push the A/C button or icon to manually turn the system on (indicator light will illuminate) and off.



**OFF mode**



B9029EU05



B9029EU06

Press the OFF button to turn the climate control system off. You can still operate the mode and air intake buttons as long as the ignition switch is in the ON position.

**Rear climate control button**



B9029EU07

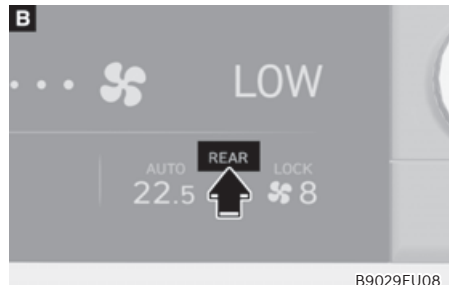

B9029EU08

If you press the rear climate control button, rear passengers can control the rear climate system.

## Rear climate control

### ■ 2nd row air conditioning control

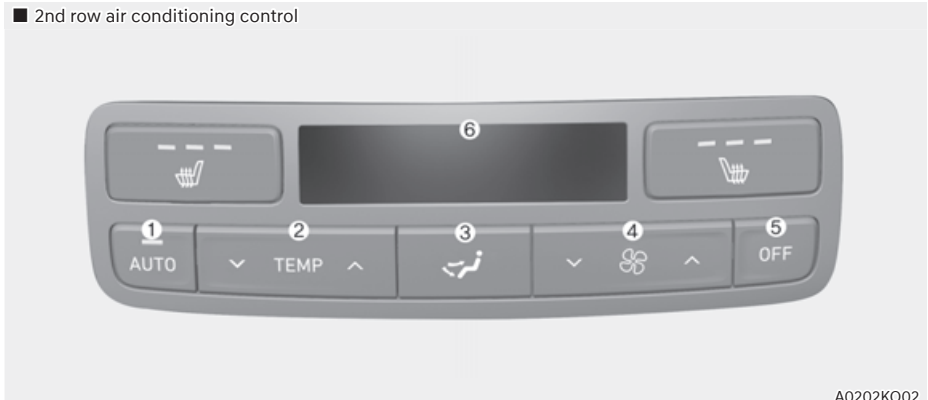

A0202K002

- |                              |                                      |
|------------------------------|--------------------------------------|
| ① AUTO button                | ④ Fan speed control button           |
| ② Temperature control button | ⑤ OFF button                         |
| ③ Mode selection button      | ⑥ Climate control information screen |

If you press the rear climate control button of the front climate control system, rear passengers can control the rear climate system by using the rear climate control system.

When you want to use the rear climate control (heating and air conditioning)

1. Press the air conditioning button of the front climate control.
2. Adjust the rear climate control (temperature, air direction and fan speed).
3. Check that “Lock Control” is not selected in the infotainment system. If “Lock Control” is selected, the rear climate control is not adjusted in the rear climate control panel.

### Fan speed control

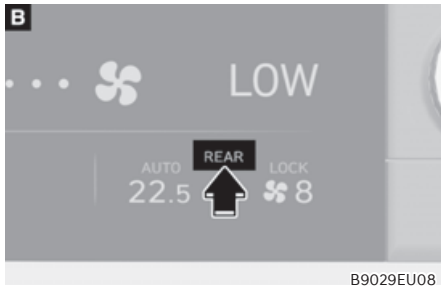

1. Press the rear climate control button or icon of the front climate control system.

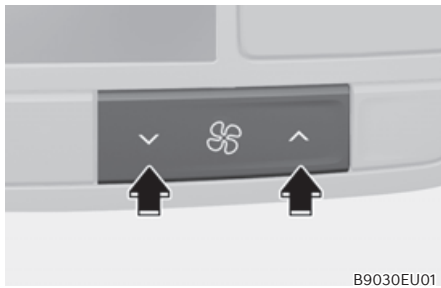

2. The fan speed can be set to the desired speed by pushing the fan speed control button. The higher the fan speed is, the more air is delivered. Pressing the OFF button turns off the fan.

### Temperature control

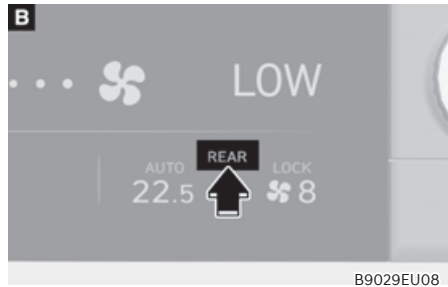

1. Press the rear climate control button of the front climate control system.

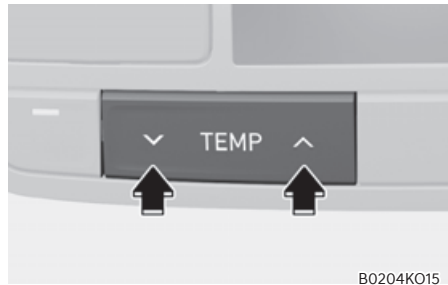

2. The temperature of delivered air can be set to the desired temperature by pushing the temperature control button. Pressing the Off button turns off the fan.

### AUTO mode

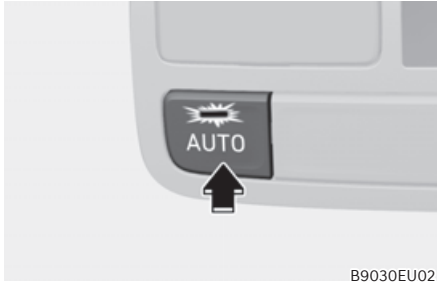

B9030EU02

The rear automatic climate control system is controlled by setting the desired temperature.

1. Press the AUTO button. The modes, fan speeds, air intake and air-conditioning will be controlled automatically by the temperature setting you select.
2. Press the temperature control button to the desired temperature.

### OFF mode

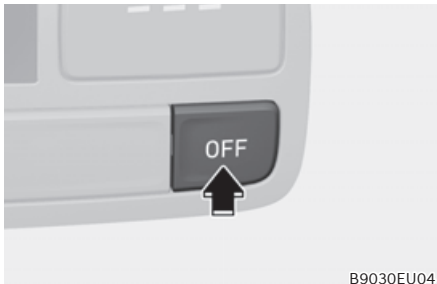

B9030EU04

Press the OFF button to turn the rear climate control system off.

### Mode selection

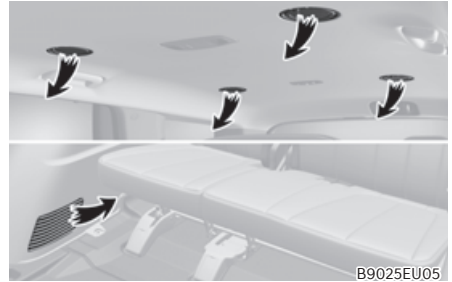

B9025EU05





B9030EU03

You can select the direction of the air flow through the ventilation system.

You can adjust the front climate control system for heating or cooling to passengers on 2nd row seats. The air flow is directed from the floor.

: Air flow is directed toward the upper body from the rear headliner.

: Air flow is directed toward the upper body and the floor.

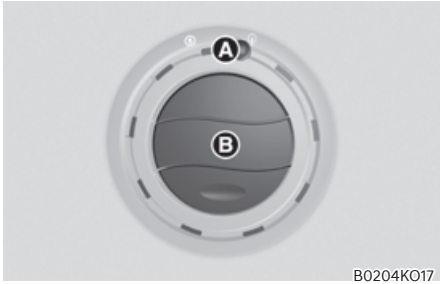

: Air flow is directed toward the floor.

**Rear vents on the headliner**



The rear passengers can adjust the direction of air flow from the rear vents on the headliner.

If you operate the rear climate control with rear vents closed, a noise may sound. When operating the rear climate control, open two or more rear vents.

No	Diffusion lever (A)	Direction thumbwheel (B)	Description
1	Open (  )	Close	The air is delivered widely toward the surroundings of rear passengers. However, the fan speed may be decreased.
2	Open (  )	Open	The air is delivered widely toward the rear passengers and surrounding of rear passengers.
3	Close (  )	Open	The air is only delivered toward the rear passengers.



## System Operation

### Cooling/Ventilation

1. Select the Face Level  mode.
2. Set the air intake control to fresh mode.
3. Set the temperature control to the desired position.
4. Set the fan speed control to the desired speed.

### Heating

1. Select the Floor Level  mode.
2. Set the air intake control to fresh mode.
3. Set the temperature control to the desired position.
4. Set the fan speed control to the desired speed.
5. If desired, turn the air conditioning ON with the temperature control knob set to heat in order to dehumidify the air before it enters into the cabin.

If the windshield fogs up, select the Floor & Defrost  mode or press the Front Defrost  mode.

### Operation Tips

- To keep dust or unpleasant fumes from entering the car through the ventilation system, temporarily set the air intake control to the recirculation mode. Return the control to the fresh mode when the unpleasant air outside has diminished. This will help keep the driver alert and comfortable.
- To help prevent the inside of the windshield from fogging, set the air intake control to fresh mode and the fan speed to the desired position, turn on the air conditioning system, and adjust the temperature control to the desired temperature.

### Air conditioning

Your HYUNDAI vehicle air conditioning system is filled with R-1234yf refrigerant.

1. Start the engine.
2. Press the air conditioning button.
3. Select the Face Level  mode.
4. Set the air intake control to Recirculation mode temporarily to allow the cabin to cool quickly. When the desired temperature in the cabin is reached, change the air intake control back to Fresh mode.
5. Adjust the fan speed control and temperature control to maintain maximum comfort.

When maximum cooling is desired, set the temperature control to the MAX A/C position, then set the fan speed control to the highest setting.

### NOTICE

**When using the air conditioning system, monitor the engine temperature gauge closely while driving up hills or in heavy traffic when outside temperatures. Air conditioning system operation when climbing a steep grade or in high outside ambient temperatures can cause engine overheating. Continue to use the fan, but turn the air conditioning system off if the engine temperature gauge indicates engine overheating.**

### Air conditioning system operation tips

- If the vehicle has been parked in direct sunlight during hot weather, open the windows for a short time to let the hot air inside the vehicle escape.
- After sufficient cooling has been achieved, switch back from recirculation mode to fresh mode.
- To help reduce moisture inside of the windows on rainy or humid days, decrease the humidity inside the vehicle by operating the air conditioning system with the windows and sunroof closed.
- Use the air conditioning system every month only for a few minutes to ensure maximum system performance.
- If you operate air conditioner excessively, the difference between the temperature of the outside air and that of the windshield could cause the outer surface of the windshield to fog up, causing loss of visibility. In this case, set the mode selection knob or button to the  position and fan speed control to the lower speed.

## System Maintenance

### Cabin air filter

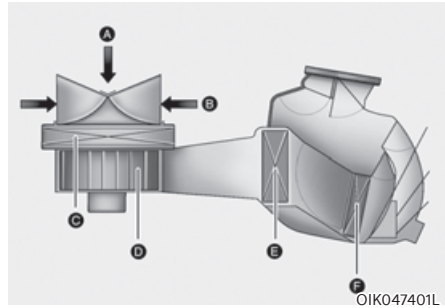

- (A): Outside air, (B): Recirculated air  
(C): Climate control air filter, (D): Blower  
(E): Evaporator core, (F): Heater core

The cabin air filter is installed behind the glove box. It filters the dust or other pollutants that enter the vehicle through the heating and air conditioning system.

Have the cabin air filter replaced by an authorized HYUNDAI dealer according to the maintenance schedule. If the vehicle is being driven in severe conditions such as dusty or rough roads and/or if transporting pets or occupants smoke inside the vehicle, then more frequent cabin air filter inspections and changes are required.

If the air flow rate suddenly decreases, the system should be checked at an authorized HYUNDAI dealer.

### **Checking the amount of air conditioner refrigerant and compressor lubricant**

When the amount of refrigerant is low, the performance of the air conditioning is reduced. Overfilling also reduces the performance of the air conditioning system.

Therefore, if abnormal operation is found, have the system inspected by an authorized HYUNDAI dealer.

#### **NOTICE**

It is important that the correct type and amount of oil and refrigerant is used. Otherwise, damage to the compressor and abnormal system operation may occur. To prevent damage, the air conditioning system in your vehicle should only be serviced by trained and certified technicians.

#### **NOTICE**

- The refrigerant system should only be serviced by trained and certified technicians to insure proper and safe operation.
- The refrigerant system should be serviced in a well-ventilated place.
- The air conditioning evaporator (cooling coil) shall never be repaired or replaced with one removed from a used or salvaged vehicle and new replacement MAC evaporators shall be certified (and labeled) as meeting SAE Standard J2842.



### **WARNING**

Vehicles equipped with R-1234yf



Since the refrigerant is operated at very high pressure, the air conditioning system should only be serviced by trained and certified technicians.

It is important that the correct type and amount of oil and refrigerant are used.

All refrigerants should be reclaimed with proper equipment.

Venting refrigerants directly to the atmosphere is harmful to individuals and environment. Failure to heed these warnings can lead to serious injuries.



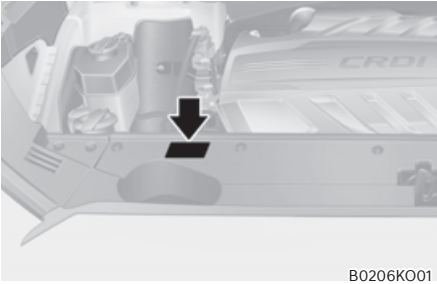

B0206K001

### Air Conditioning refrigerant label

You can find out which air conditioning refrigerant is applied to your vehicle on the label located in front of engine compartment.

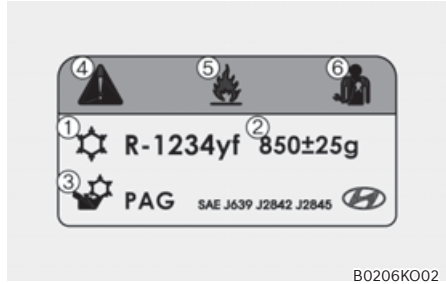

B0206K002

Each symbol and specification on the air conditioning refrigerant label is represented as below:



- ① Classification of refrigerant
- ② Amount of refrigerant
- ③ Classification of compressor lubricant
- ④ Caution
- ⑤ Flammable refrigerant
- ⑥ To require registered technician to service air conditioning system

## WINDSHIELD DEFROSTING AND DEFOGGING



### WARNING

#### Windshield heating

Do not use the  or  position during cooling operation in extremely humid weather. The difference between the temperature of the outside air and that of the windshield could cause the outer surface of the windshield to fog up, causing loss of visibility could cause an accident resulting in serious injury or death. In this case, set the mode selection knob or button to the  position and fan speed control knob or button to a lower speed.

- For maximum defrost performance, set the temperature control knob to the highest temperature setting (rotated all the way to the right) and the fan speed control to the highest setting.
- If warm air to the floor is desired while defrosting or defogging, set the mode to the floor-defrost position.
- Before driving, clear all snow and ice from the windshield, rear window, side view mirrors, and all side windows.
- Clear all snow and ice from the hood and air inlet in the cowl grill to improve heater and defroster efficiency and to reduce the probability of fogging up the inside of the windshield.



### NOTICE

If the engine temperature is still cold after starting, then a brief engine warm up period may be required for the vented air flow to become warm or hot.

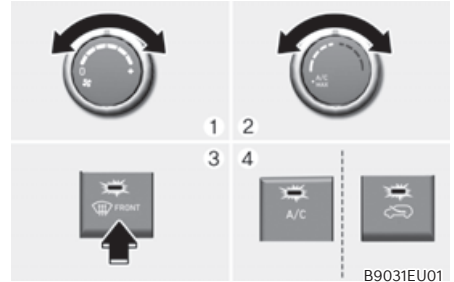
### Manual Climate Control System



#### To defog inside windshield

1. Select any fan speed except “0” position.
2. Select the desired temperature.
3. Select the  or  position.
4. Fresh mode will be selected automatically. Additionally, the air conditioning will automatically operate if the mode is selected to the  position.

Check to make sure the A/C is ON. If the A/C ON indicator is not illuminated, press the A/C button once to turn the air conditioner ON.

Check to make sure the air intake control is in Fresh mode. If the air intake control indicator is illuminated, press the button once to enable Fresh mode (indicator OFF).

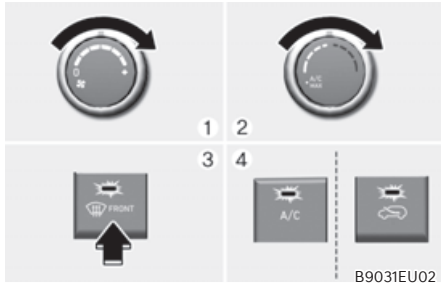

**To defrost outside windshield**

1. Set the fan speed to the highest setting (knob rotated all the way to the right).
2. Set the temperature control to the highest temperature setting.
3. Select the  position.
4. Fresh mode (Recirculation OFF) and A/C ON will automatically be selected.

**Automatic Temperature Control System (if equipped)**

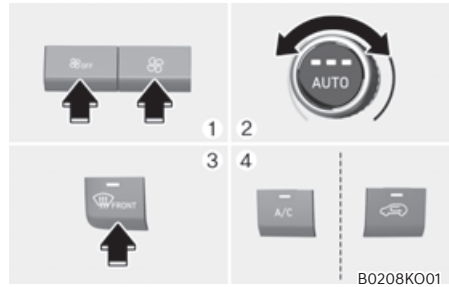

**To defrost inside windshield**

1. Select the desired fan speed.
2. Select the desired temperature.
3. Press the defroster button ().
4. Fresh mode will be selected automatically.

Check to make sure the air intake control is in Fresh mode. If the air intake control indicator is illuminated, press the button once to enable Fresh mode (indicator OFF).

If the  position is selected, the fan speed is automatically increased.

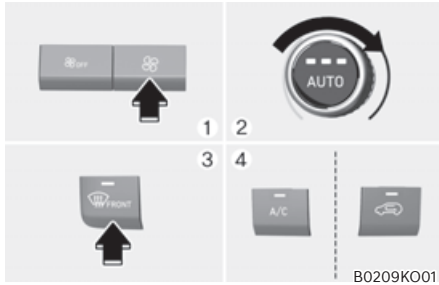

### To defrost outside windshield

1. Set the fan speed to the highest position.
2. Set the temperature to the extreme hot (HI) position.
3. Press the defroster button (🚗).
4. The outside (fresh) air position will be selected automatically.

If the 🚗 position is selected, lower fan speed is adjusted to a higher fan speed.

### Defogging logic

To reduce the probability of fogging up the inside of the windshield, the air intake or air conditioning are controlled automatically according to certain conditions such as 🚗 or 🚗 positions. To cancel or reset the defogging logic, do the following.

#### Manual climate control system

1. Turn the ignition switch to the ON position.
2. Press the defroster button (🚗).
3. Press the air intake control button at least 5 times within 3 seconds.

The indicator on the air intake button will blink 3 times to indicate that the defogging logic has been disabled.

Repeat the steps again to re-enable the defogging logic.

If the battery has been discharged or disconnected, it resets to the defog logic status.

#### Automatic climate control system

1. Turn the ignition switch to the ON position.
2. Press the defroster button (🚗).
3. While pressing the air conditioning button (A/C), press the air intake control button at least 5 times within 3 seconds.

The Automatic Climate Control information screen will blink 3 times to indicate that the defogging logic has been dis-abled.

Repeat the steps again to re-enable the defogging logic.

If the battery has been discharged or disconnected, it resets to the defog logic status.



When the Auto Defogging System operates, the indicator will illuminate.

If a high amount of humidity is detected in the vehicle, the Auto Defogging System will be enabled. The following steps will be performed automatically:

- Step 1) The A/C button will turn ON and the air intake or icon control will change to Fresh mode.
- Step 2) The mode will be changed to defrost to direct airflow to the windshield.
- Step 3) The fan speed will be rising up to level 3.

If the air conditioning is off or recirculated air position is manually selected while Auto Defogging System is ON, the Auto Defogging System Indicator will blink 3 times to signal that the manual operation has been canceled.

### To cancel or reset the Auto Defogging System

Press the front windshield defroster button for 3 seconds when the ignition switch is in the ON position. When the Auto Defogging System is canceled, the ADS OFF symbol will blink 3 times and ADS OFF will be displayed on the climate control information screen.

When the Auto Defogging System is reset, the ADS OFF symbol will blink 6 times without a signal.

### Information

**To maintain the effectiveness and efficiency of the Auto Defogging System, do not select Recirculation mode while the system is operating.**

### **NOTICE**

**Do not remove the sensor cover located on the upper end of the windshield glass.**

**Damage to system parts could occur and may not be covered by your vehicle warranty.**

## Rear Window Defroster

### NOTICE

To prevent damage to the rear window defroster conducting elements bonded to the inside surface of the rear window, never use sharp instruments or window cleaners containing abrasives to clean the window.

If you want to defrost and defog the front windshield, refer to the “Windshield Defrosting and Defogging” section in this chapter.



The defroster heats the window to remove frost, fog and thin ice from the interior and exterior of the rear window, while the engine is running.

- To activate the rear window defroster, press the rear window defroster button located in the center control panel. The indicator on the rear window defroster button illuminates when the defroster is ON.
- To turn off the defroster, press the rear window defroster button again.

### **i** Information

- If there is heavy accumulation of snow on the rear window, brush it off before operating the rear defroster.
- The rear window defroster automatically turns off after approximately 20 minutes or when the ignition switch or Engine Start/Stop button is in the LOCK/OFF position.

### **Side view mirror defroster**

If your vehicle is equipped with the side view mirror defrosters, they will operate at the same time you turn on the rear window defroster.

## CLIMATE CONTROL ADDITIONAL FEATURES

### Auto Defogging System

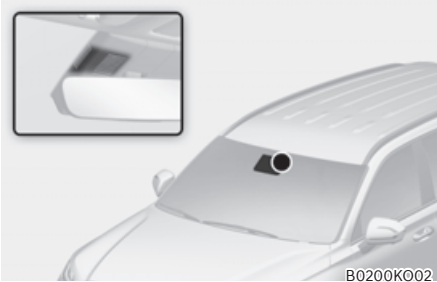

B0200K002

Auto defogging helps reduce the possibility of fogging up the inside of the windshield by automatically sensing the moisture on inside the windshield.

The auto defogging system operates when the heater or air conditioning is on.

#### **i** Information

**The auto defogging system may not operate normally, when the outside temperature is below 14 °F (-10 °C).**

If the air conditioning is off or recirculation mode is manually selected while Auto Defogging System is ON, the Auto Defogging System indicator will blink 3 times to signal that the manual operation has been canceled.

### **Turning the Auto Defogging System On or off**

#### **Infotainment system**

Auto Defogging System can be turned on and off by selecting 'Setup → Vehicle → Climate → Defog/Defrost Options → Auto Defog' from the infotainment system screen.

#### **i** Information

- **To maintain the effectiveness and efficiency of the Auto Defogging System, do not select Recirculation mode while the system is operating.**
- **The infotainment system may change after software updates. For more information, refer to the user's manual provided in the infotainment system and the quick reference guide.**

#### **NOTICE**

**Do not remove the sensor cover located on the upper end of the windshield glass.**

**Damage to system parts could occur and may not be covered by your vehicle warranty.**

## Auto Dehumidify (if equipped)

To increase cabin air quality and reduce windshield misting, recirculation mode switches off automatically after about 5 to 30 minutes, depending on the outside temperature, and the air intake will change to fresh mode.

### Turning Auto Dehumidify On or off

#### Climate control system

To turn the Auto Dehumidify feature on or off, select Face level (👤) mode and press the A/C button, press the air intake control (🌬️) button at 5 times within 3 seconds. When Auto Dehumidify is turned on, the air intake control button indicator will blink 6 times. When turned off, the indicator will blink 3 times.

#### Infotainment system

Auto Dehumidify can be turned on and off by selecting 'Setup → Vehicle → Climate → Automatic Ventilation → Auto Dehumidify' from the infotainment system screen.

### Information

**The infotainment system may change after software updates. For more information, refer to the user's manual provided in the infotainment system and the quick reference guide.**

## Recirculating Air When Washer Fluid Is Used

Recirculation mode automatically activates to reduce any objectionable scent of the washer fluid from entering the cabin when the windshield washer is used.

### Turning Activate upon Washer Fluid Use On or off

#### Climate control system

To turn the 'Activate upon Washer Fluid Use' feature on or off, select Floor level (👤) mode, and then press the air intake control (🌬️) button four times within two seconds while pressing the A/C button or icon.

When 'Activate upon Washer Fluid Use' is turned on, the air intake control button indicator will blink 6 times. When turned off, the indicator will blink 3 times.

#### Infotainment system

Activate upon Washer Fluid Use can be turned on and off by selecting 'Setup → Vehicle → Climate → Recirculate Air → Activate upon Washer Fluid Use (or Interlocking washer fluid)' from the infotainment system screen.

However, in cold weather to help prevent the windshield from fogging up, the recirculation mode may not be selected.

### Information

**The infotainment system may change after software updates. For more information, refer to the user's manual provided in the infotainment system and the quick reference guide.**



### Sunroof Inside Air Recirculation (if equipped)

When the sunroof is opened, fresh mode will be automatically selected. At this time, if you press the air intake control button, recirculation mode will be selected but will change back to fresh mode after 3 minutes. When the sunroof is closed, the air intake position will return to the original position that was selected.

### Scheduled Ventilation Control

The Scheduled Ventilation Control releases hot air in the vehicle to lower cabin temperature before getting in the vehicle.

Depending on the outside ambient temperature, the blower is operated for 5 to 15 minutes while the vehicle is parked.

### ***Turning Schedule Ventilation Control On or Off***

The Schedule Ventilation Control can be turned on and off by selecting 'Setup → Vehicle → Automatic Ventilation → Scheduled Ventilation Control' from the infotainment system screen. Also, the starting time can be set within 24 hours. Schedule Ventilation Control operates only once when the feature is set.

### **Information**

**The infotainment system may change after software updates. For more information, refer to the user's manual provided in the infotainment system and the quick reference guide.**

## STORAGE COMPARTMENT

### WARNING

Never store cigarette lighters, propane cylinders, or other flammable/explosive materials in the vehicle. These items may catch fire and/or explode if the vehicle is exposed to hot temperatures for extended periods.

### WARNING

**ALWAYS** keep the storage compartment covers closed securely while driving. Items inside your vehicle are moving as fast as the vehicle. If you have to stop or turn quickly, or if there is a crash, the items may fly out of the compartment and may cause an injury if they strike the driver or a passenger.

### **NOTICE**

To avoid possible theft, do not leave valuables in the storage compartments.

## Center Console Storage



To open:  
Press the button.

## Glove Box

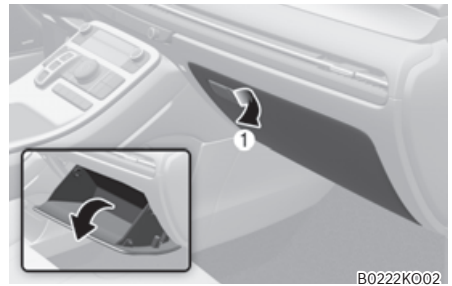

To open:  
Pull the lever ①.

### WARNING

**ALWAYS** close the glove box door after use.

An open glove box door can cause serious injury to the passenger in an accident, even if the passenger is wearing a seat belt.

## INTERIOR FEATURES

### Cup Holder



Ⓐ: Driver and passenger seat

Cups or small beverages cups may be placed in the cup holders.

Push the button and the cover opens. Push the buttons and the cup supporter protrudes from the front console. Push in the cup supporter securely after use.



### CAUTION

Do not place thin objects (coin, card etc.) on the cover. These may fall into the inside when the cover is operated.

### Rear (2<sup>nd</sup> row, 3<sup>rd</sup> row)

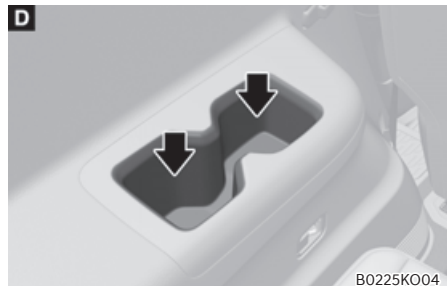
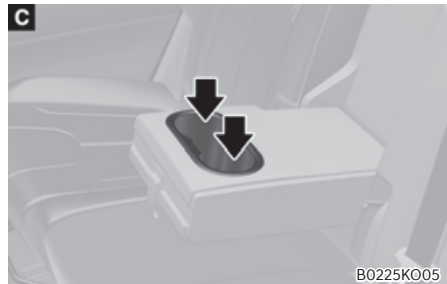
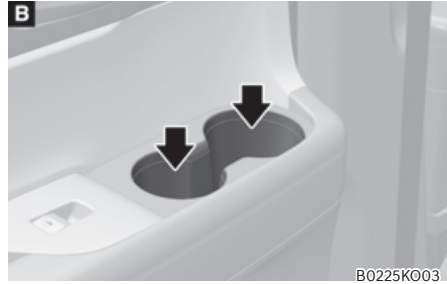

- Ⓑ: 2<sup>nd</sup> row seat,
- Ⓒ: 2<sup>nd</sup> row seat armrest (if equipped),
- Ⓓ: 3<sup>rd</sup> row seat

Cups or small beverages cups may be placed in the cup holders.

**WARNING**

- Avoid abrupt starting and braking when the cup holder is in use to prevent spilling your drink. If hot liquid spills, you could be burned. Such a burn to the driver could cause loss of vehicle control resulting in an accident.
- Do not place uncovered or unsecured cups, bottles, cans, etc., in the cup holder containing hot liquid while the vehicle is in motion. Injuries may result in the event of a sudden stop or collision.
- Only use soft cups in the cup holders. Hard objects can injure you in an accident.

**WARNING**

Keep cans or bottles out of direct sun light and do not put them in a hot vehicle. It may explode.

**NOTICE**

- Keep your drinks sealed while driving to prevent spilling your drink. If liquid spills, it may get into the vehicle's electrical/electronic system and damage electrical/electronic parts.
- When cleaning spilled liquids do not use hot air to blow out or dry the cup holder. This may damage the interior.

### Conversation mirror

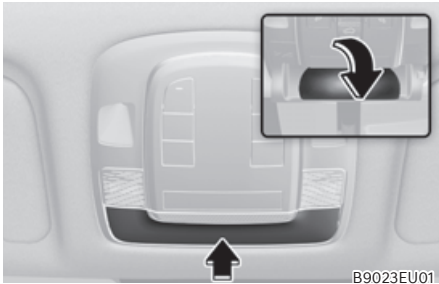

You can see widely the rear view through the conversation mirror.

To open:

Press the cover and the holder will slowly open.

To close:

Push back into position.

### Sunvisor

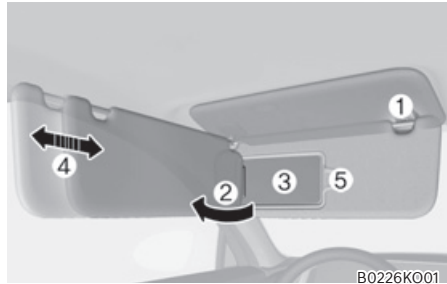

To use the sunvisor, pull it downward.

To use the sunvisor to block the sun from the side window, pull it rearward, release it from the bracket ① and swing it to the side ② towards the window.

To use the vanity mirror, pull down the sunvisor and slide the mirror cover ③.

Adjust the sunvisor forward or backward ④ as needed (if equipped). Use the ticket holder ⑤ to hold tickets.

Close the vanity mirror cover securely and return the sunvisor to its original position after use.

#### **WARNING**

**For your safety, do not block your view when using the sunvisor.**

#### **NOTICE**

**The tab ⑤ adjacent to the vanity mirror on the sunvisor can be used for toll road tickets or self parking tickets. Use caution when inserting tickets into the ticket holder to avoid damage. Refrain from putting several tickets in the ticket holder as this could also damage the retaining tab.**

## Power Outlet

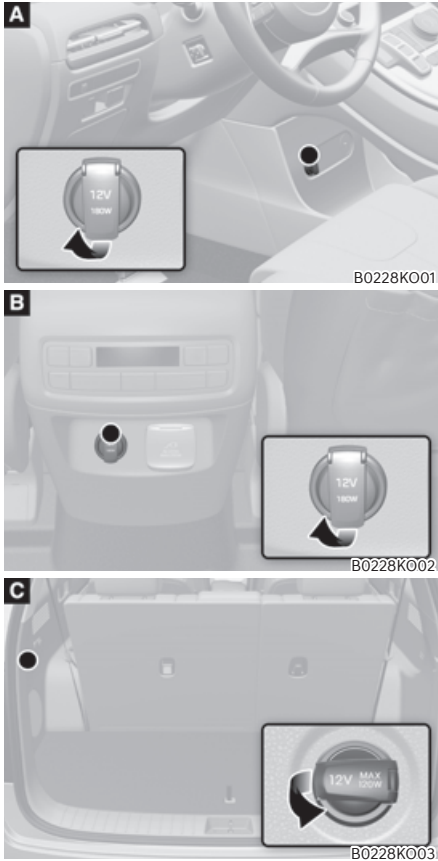

(A): Front, (B): Rear (2<sup>nd</sup> row),  
(C): Luggage compartment

The power outlet is designed to provide power for mobile telephones or other devices designed to operate with vehicle electrical systems.

The devices should draw less than 180 W with the engine running.

## WARNING

Avoid electrical shocks. Do not place your fingers or foreign objects (pin, etc.) into a power outlet or touch the power outlet with a wet hand.

## **NOTICE**

To prevent damage to the power outlets:

- Use the power outlet only when the engine is running and remove the accessory plug after use. Using the accessory plug for prolonged periods of time with the engine off could cause the battery to discharge.
- Only use 12 volts electric accessories which are less than 180 watts in electric capacity.
- Adjust the air-conditioner or heater to the lowest operating level when using the power outlet.
- Close the cover when not in use.
- Some electronic devices can cause electronic interference when plugged into a vehicle's power outlet. These devices may cause excessive audio static and malfunctions in other electronic systems or devices used in your vehicle.
- Push the plug in as far as it will go. If good contact is not made, the plug may overheat and the fuse may open.
- Plug in battery equipped electrical/ electronic devices with reverse current protection. The current from the battery may flow into the vehicle's electrical/electronic system and cause system malfunction.

## USB Charger



(A): Front, (B): Rear (2nd row)



- (C): Rear (3rd row, left side),
- (D): Rear (3rd row, right side),
- (E): Center console storage (if equipped)

The USB charger is designed to recharge batteries of small size electrical devices using a USB cable.

The electrical devices can be recharged when the ignition switch is in the ON or START position.

The battery charging state may be monitored on the electrical device.

Disconnect the USB cable from the USB port after use.

- A smart phone or a tablet PC may get warmer during the re-charging process. It does not indicate any malfunction with the charging system.
- A smart phone or a tablet PC, which adopts a different re-charging method, may not be properly re-charged. In this case, use an exclusive charger of your device.
- The charging terminal is only to recharge a device. Do not use the charging terminal either to turn ON an audio or to play media in the infotainment system.

### **i** Information

Charging may not be possible when using a Type-C converter sold by a mobile phone manufacturer or commercially available.

### **NOTICE**

- **Use the USB charger when the engine is running. Using the USB charger for prolonged periods of time with the engine off could cause the battery to discharge.**
- **To prevent damage to the USB charger:**
  - **Do not insert foreign objects or spill liquid into the outlet. The USB charging terminal may be damaged.**
  - **Do not use devices with current consumption exceeding 2,100 mA (2.1 A).**

### AC Inverter (if equipped)



The AC inverter supplies 115 volts (150 watts) electric power to operate electric accessories or equipment.

B0920EU01



## **i** Information



- **Rated voltage : AC 115 volts**
- **Maximum electric power : 150 watts**
- **In order to avoid an electrical system failure, electric shock, etc., be sure to read owner's manual before use.**
- **Be sure to close the cover except the time of use.**

## **!** WARNING

To reduce a risk of serious or fatal injuries:

- **Do not use a heated electric device such as a coffeepot, toaster, heater, iron, etc.**
- **Do not insert foreign objects into the outlet and do not touch the outlet as you may get shocked.**
- **Do not let children touch the AC inverter.**

## **NOTICE**

- **To prevent the battery from being discharged, do not use the AC inverter while the engine is not running.**
- **When not using the AC inverter, make sure to close the AC inverter cover.**
- **After using an electric accessory or equipment, pull the plug out. Leaving the accessory or equipment plugged in for a long time may cause battery discharge.**
- **Do not use an electric accessory or equipment the power consumption of which is greater than 220 volts/200 watts.**
- **Some electric accessories or equipment can cause electronic interference. It may cause excessive audio noise and malfunctions in other electric systems or devices in the vehicle.**
- **Do not use broken electric accessories or equipment, which may damage the AC inverter and electrical systems of the vehicle.**
- **Do not use two or more electric accessories or equipment at the same time. It may cause damage to the electrical systems of the vehicle.**
- **When the input voltage is lower, outlet LED will blink and the AC inverter will turn off automatically. If the input voltage goes up to normal, the AC inverter will turn on again.**

## Wireless Smart Phone Charging System

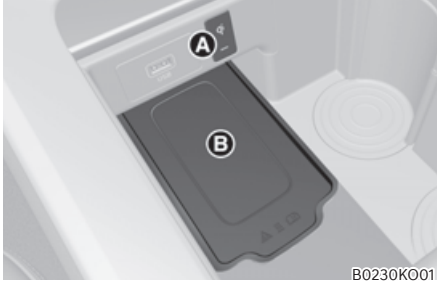

(A): Indicator light, (B): Charging pad

On certain models, the vehicle comes equipped with a wireless smart phone charger.

The system is available when all doors are closed, and when the ignition switch or Engine Start/Stop button is in the ON or START position.

### **Charging smart phone**

Visit your smart phone manufacturer's website to check whether your smart phone supports the Qi technology.

The wireless charging process starts when you put a Qi-enabled smart phone on the wireless charging unit with the screen facing up.

1. The wireless smart phone charger is available when all doors are closed, and when the ignition switch is in the ON or START position.

2. Turn on the wireless charging function from the Settings menu in the infotainment system. Select:
  - Setup → Vehicle → Convenience → Wireless Charging System
3. Place the smart phone in the center of the wireless charging pad. The indicator light is orange when the smart phone is charging and turns blue when phone charging is complete.

### **i Information**

**Remove other items, including the smart key and the card key from the wireless charging pad.**

The indicator light will blink orange for 10 seconds if there is a malfunction in the wireless charging system.

In this case, temporarily stop the charging process, and re-attempt to charge your smart phone again.

The system warns you with a message on the LCD display if the smart phone is still on the wireless charging unit after the vehicle is turned OFF and the front door is opened.

For some manufacturer's smart phones, the system may not warn you even though the smart phone is left on the wireless charging unit. This is due to the particular characteristic of the smart phone and not a malfunction of the wireless charging.

### **NOTICE**

- The wireless smart phone charging system may not support certain smart phones, which are not verified for the Qi specification (Qi).
- When placing your smart phone on the charging pad, position the phone in the middle of the mat for optimal charging performance. If your smart phone is off to the side, the charging rate may be less and in some cases the smart phone may experience higher heat conduction.
- In some cases, the wireless charging may stop temporarily when the smart key is used, either when starting the vehicle or locking/unlocking the doors, etc.
- When charging certain smart phones, the charging indicator may not change to blue when the smart phone is fully charged.
- The wireless charging process may temporarily stop, when temperature abnormally increases inside the wireless smart phone charging system. The wireless charging process restarts, when temperature falls to a certain level.
- The wireless charging process may temporarily stop when there is any metallic item, such as a coin, between the wireless smart phone charging system and smart phone.
- When charging some smart phones with a self-protection feature, the wireless charging speed may decrease and the wireless charging may stop.
- If the smart phone has a thick cover, the wireless charging may not be possible.
- If the smart phone is not completely contacting the charging pad, wireless charging may not operate properly.
- If the ignition switch or Engine Start/ Stop button is in the OFF position, the charging also stops.
- When any smart phone without a wireless charging function or a metallic object is placed on the charging pad, a small noise may sound. This small sound is due to the vehicle discerning compatibility of the object placed on the charging pad. It does not affect your vehicle or the smart phone in any way.
- Some smart phones may not be able to charge depending on the internal structure of the smart phone. If this occurs, try charging the mobile phone by moving it to the left or right side of the wireless charging pad. However, for some foldable smart phones that have magnets inside the smart phone, try charging the smart phone while holding it close to the left side of the wireless charging pad.

**NOTICE**

Some magnetic items like credit cards, phone cards or rail tickets may be damaged if left with the smart phone during the charging process.

***i* Information**

This device complies with Part 15 of the FCC rules.

Operation is subject to the following three conditions:

1. This device may not cause harmful interference, and
2. This device must accept any interference received, including interference that may cause undesired operation.
3. Changes or modifications not expressly approved by the party responsible for compliance could void the user's authority to operate the device.

**Clock**

The clock can be set from the infotainment system.

**WARNING**

**Do not attempt to adjust the clock while driving. Doing so may result in distracted driving which may lead to an accident involving personal injury or death.**

**Information**

For more information, refer to the user's manual provided in the infotainment system and the quick reference guide.

## Coat Hook



These hooks are not designed to hold large or heavy items.

### **WARNING**

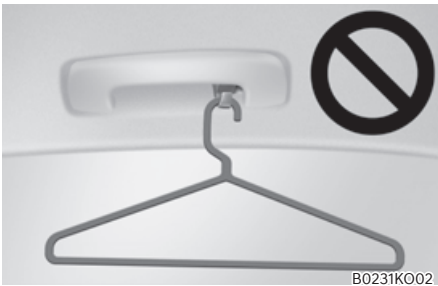

Do not hang other objects such as hangers or hard objects except clothes. Also, do not put heavy, sharp or breakable objects in the clothes pockets. In an accident or when the curtain air bag is inflated, it may cause vehicle damage or personal injury.

## Floor Mat Anchor(s)

ALWAYS use the Floor Mat Anchors to attach the front floor mats to the vehicle. The anchors on the front floor carpet keep the floor mats from sliding forward.

### **WARNING**

Do not overlay additional mats or liners over the floor mats. If using All Weather mats, remove the carpeted floor mats before installing them. Only use floor mats designed to connect to the anchors.

## WARNING

The following must be observed when installing ANY floor mat to the vehicle.

- Ensure to remove a protective film attached on the carpet before attaching a floor mat on the front floor carpet. Otherwise, the floor mat may move freely on the protective film and it could result in unintentional braking or accelerating.
- Ensure that the floor mats are securely attached to the vehicle's floor mat anchor(s) before driving the vehicle.
- Do not use ANY floor mat that cannot be firmly attached to the vehicle's floor mat anchors.
- Do not stack floor mats on top of one another (for example, all-weather rubber mat on top of a carpeted floor mat). Only a single floor mat should be installed in each position.

## NOTICE

Your vehicle was manufactured with driver's side floor mat anchors that are designed to securely hold the floor mat in place. To avoid any interference with pedal operation, HYUNDAI recommends that the HYUNDAI floor mat designed for use in your vehicle be installed.

## Rear Side Window Sunshades (if equipped)

Use the rear side window sunshade to block external light coming through the rear window glass.

### Manual sunshades

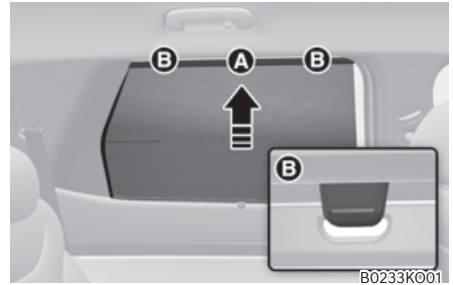

1. Lift the sunshade by the handle (A).
2. Hang the sunshade on both sides of the hook (B). If the sunshade is hung on one side of the hook, the sunshade may be wrinkled.

## NOTICE

- Do not hang any other object except the rear side window sunshade on the hooks.
- If you pull the rear side window sunshade or apply force to return the sunshade to its original position after use, you may find the sunshade wrinkled or out of shape. To lower the sunshade, be sure to put the handle downward and slowly return the sunshade to its original position.
- Sunshades may not work properly if foreign objects (coins, toys, cookies, etc.) are stuck in the door. Be careful that the foreign objects do not get into the door.

### Cargo Net Holder (if equipped)

To keep items from shifting in the cargo area, you can use the 4 holders located in the luggage board to attach a cargo net.

Make sure the cargo net is securely attached to the holders in the luggage board.

If necessary, contact your authorized HYUNDAI dealer to obtain a luggage net.



### WARNING

Avoid eye injury. **DO NOT** overstretch the cargo net. **ALWAYS** keep your face and body out of the cargo net's recoil path. **DO NOT** use the cargo net when the strap has visible signs of wear or damage.

Use the cargo net to keep only light items from shifting in the cargo area.

### Cargo Security Screen (if equipped)

Use the cargo security screen to cover items stored in the cargo area.

#### Using the cargo security screen

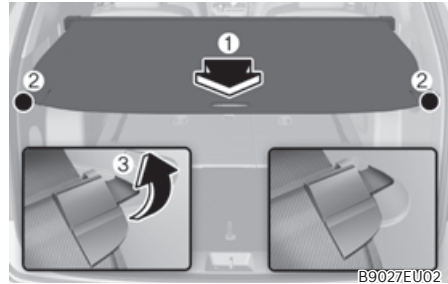

1. Pull the cargo security screen towards the rear of the vehicle by the handle ①.
2. Insert the guide pin ② into the guide ③.

### **i** Information

**Pull out the cargo security screen with the handle in the center to prevent the guide pin from falling out of the guide.**

When the cargo security screen is not in use:

1. Pull the cargo security screen rearward and up to release it from the guides.
2. The cargo security screen will automatically slide back in.

### Information

The cargo security screen may not automatically slide back in if the cargo security screen is not fully pulled out. Pull the cargo screen out all the way and then slowly allow the screen to retract back in.

### **NOTICE**

Since the cargo security screen may be damaged or malformed, do not put luggage on it when it is used.

### WARNING

- Do not place objects on the cargo security screen. Such objects may be thrown about inside the vehicle and possibly injure vehicle occupants during an accident or when braking.
- Never allow anyone to ride in the luggage compartment. It is designed for luggage only.
- Maintain the balance of the vehicle and locate the weight as forward as possible.

### **Removing the cargo security screen**

1. Push one side of the cargo screen inward to compress the spring and release the screen from the vehicle.
2. While the spring is compressed, pull out the cargo security screen.
3. Open the luggage tray and keep the cargo security screen in the tray.



**Removing the cargo security screen from the luggage tray**

**NOTICE**

Since the cargo security screen may be damaged or malformed, do not put luggage on it when it is used.

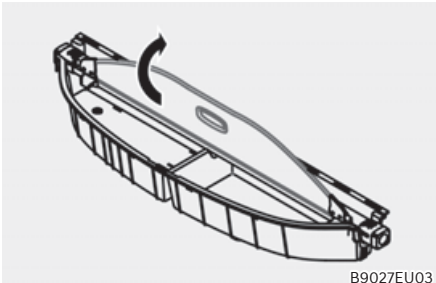

1. Pull up the screen board.

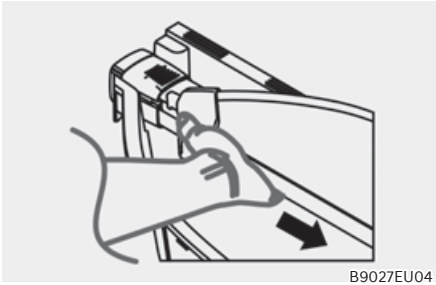

2. Push in the guide pin.

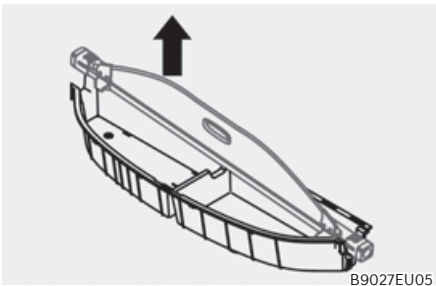

3. While pushing the guide pin, pull out the cargo security screen.

## EXTERIOR FEATURES

### Roof Side Rails

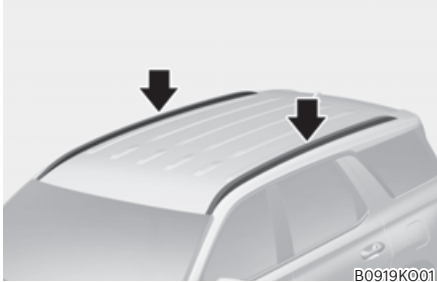

If your vehicle comes with roof side rails, then roof side rails crossbars can be installed on top of your vehicle.

The roof side rails crossbars are an accessory and are available at your local HYUNDAI dealer.

#### NOTICE

If the vehicle is equipped with a sunroof, be sure not to position cargo onto the roof side rails in such a way that it could interfere with sunroof operation.

#### NOTICE

- When carrying cargo on the roof side rails, take the necessary precautions to make sure the cargo does not damage the roof of the vehicle.
- When carrying large objects on the roof side rails, make sure they do not exceed the overall roof length or width.



#### WARNING

- The following specification is the maximum weight that can be loaded onto the roof side rails. Distribute the load as evenly as possible onto the roof side rails and secure the load firmly.

Loading cargo or luggage in excess of the specified weight limit on the roof side rails may damage your vehicle.

ROOF SIDE RAILS	220 lbs. (100 kg) EVENLY DISTRIBUTED
-----------------	---

- The vehicle center of gravity will be higher when items are loaded onto the roof side rails. Avoid sudden starts, braking, sharp turns, abrupt maneuvers or high speeds that may result in loss of vehicle control or rollover resulting in an accident.
- Always drive slowly and turn corners carefully when carrying items on the roof side rails. Severe wind updrafts, caused by passing vehicles or natural causes, can cause sudden upward pressure on items loaded on the roof side rails. This is especially true when carrying large, flat items such as wood panels or mattresses. This could cause the items to fall off the roof side rails and cause damage to your vehicle or others around you.
- To prevent damage or loss of cargo while driving, check frequently before or while driving to make sure the items on the roof side rails are securely fastened.

## INFOTAINMENT SYSTEM

### NOTICE

- If you install an aftermarket HID head lamp, your vehicle's audio and electronic devices may not function properly.
- Prevent chemicals such as perfume, cosmetic oil, sun cream, hand cleaner, and air freshener from contacting the interior parts because they may cause damage or discoloration.

### USB Port



B0241K001

You can use an USB cable to connect audio devices to the vehicle USB port.

### **i** Information

When using a portable audio device connected to the power outlet, noise may occur during playback. If this happens, use the portable audio device's power source.

### Antenna



B0237K001

The shark fin antenna will receive AM, FM broadcast and SXM channel signals and transmit data.

### Steering Wheel Remote Controls

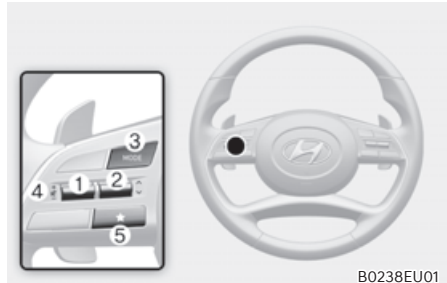

B0238EU01

### NOTICE

Do not operate multiple audio remote control buttons simultaneously.

**① VOLUME (VOL + / VOL -)**

Push the lever up or down to adjust the volume.

**② SEEK/PRESET (^ / v)**

If the SEEK/PRESET switch is pressed up or down and held for 0.8 second or more, it will function in the following modes:

- **RADIO mode**  
It will function as the AUTO SEEK select button. It will SEEK until you release the button.
- **MEDIA mode**  
It will function as the FF/RW button.

If the SEEK/PRESET switch is pressed up or down, it will function in the following modes:

- **RADIO mode**  
It will function as the PRESET STATION UP/DOWN button.
- **MEDIA mode**  
It will function as the TRACK UP/DOWN button.

**③ MODE**

Press the MODE button to toggle through Radio mode.

**④ MUTE (🔇)**

- Press the MUTE (🔇) button to mute or activate the sound.

**⑤ Custom (★)**

Press the Custom button to set frequently used features.

**Information**

The infotainment system may change after software updates. For more information, refer to the user's manual provided in the infotainment system and the quick reference guide.

**Infotainment System**

B0239K001

For more information, refer to the user's manual provided in the infotainment system and the quick reference guide.

**Voice Recognition**

B0243K001

For more information, refer to the user's manual provided in the infotainment system and the quick reference guide.

## Bluetooth® Wireless Technology

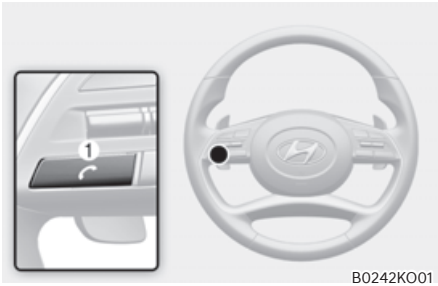

B0242KO01



B0242EU02

- ① Call/Answer/Call end button
- ② Microphone

For more information, refer to the user's manual provided in the infotainment system and the quick reference guide.



### CAUTION

**To avoid driver distractions, do not excessively operate the device while driving the vehicle which may lead to an accident.**

# 6. Driving Your Vehicle

Before Driving .....	6-4
Before Entering the Vehicle.....	6-4
Before Starting .....	6-4
Ignition Switch .....	6-5
Key Ignition Switch.....	6-5
Engine Start/Stop Button .....	6-8
Vehicle Auto-Shut Off.....	6-13
Operating Conditions .....	6-13
Deactivating Conditions .....	6-13
System Operation.....	6-13
Automatic Transmission .....	6-14
Automatic Transmission Operation.....	6-14
LCD Display Messages (Cluster).....	6-20
Paddle Shifter (Manual Shift Mode).....	6-25
Good Driving Practices .....	6-25
Braking System .....	6-27
Power-Assist Brakes .....	6-27
Disc Brakes Wear Indicator.....	6-27
Electronic Parking Brake (EPB).....	6-28
Auto Hold .....	6-33
Anti-Lock Brake System (ABS).....	6-36
Electronic Stability Control (ESC) .....	6-38
Vehicle Stability Management (VSM) .....	6-40
Hill-Start Assist Control (HAC).....	6-42
Trailer Stability Assist (TSA) .....	6-42
Downhill Brake Control (DBC).....	6-43
Good Braking Practices .....	6-46
All Wheel Drive (AWD) .....	6-47
All Wheel Drive (AWD) Operation.....	6-47
AWD Operation.....	6-48
Emergency Precautions.....	6-50
Idle Stop and Go (ISG) .....	6-52
ISG System Operation.....	6-52
ISG System Off .....	6-54
Forced to Restart Engine .....	6-55
ISG Malfunction.....	6-55
Calibrating the Battery Sensor .....	6-55

- Drive Mode Integrated Control System..... 6-57
  - Selecting Drive Mode..... 6-57
  - Changing Drive Mode ..... 6-57
  - CUSTOM Mode Features ..... 6-58
  - Multi Terrain Mode (AWD) ..... 6-59
  - TOW Mode ..... 6-60
- Special Driving Conditions..... 6-61
  - Hazardous Driving Conditions ..... 6-61
  - Rocking the Vehicle ..... 6-61
  - Smooth Cornering..... 6-62
  - Driving at Night ..... 6-62
  - Driving in the Rain..... 6-63
  - Driving in Flooded Areas..... 6-63
  - Highway Driving..... 6-63
  - Reducing the Risk of a Rollover ..... 6-64
- Winter Driving ..... 6-65
  - Snow or Icy Conditions ..... 6-65
  - Winter Precautions..... 6-68
- Trailer Towing ..... 6-70
  - If You Decide to Pull a Trailer? ..... 6-70
  - Trailer Towing Equipment ..... 6-72
  - Driving with a Trailer ..... 6-73
  - Maintenance When Towing a Trailer ..... 6-76
- Vehicle Load Limit ..... 6-77
  - The Loading Information Label ..... 6-78

**WARNING**

**Carbon monoxide (CO) gas is toxic. Breathing CO can cause unconsciousness and death.**

Engine exhaust contains carbon monoxide which cannot be seen or smelled.

**Do not inhale engine exhaust.**

If at any time you smell engine exhaust inside the vehicle, open the windows immediately. Exposure to CO can cause unconsciousness and death by asphyxiation.

**Be sure the exhaust system does not leak.**

The exhaust system should be checked whenever the vehicle is raised to change the oil or for any other purpose. If you hear a change in the sound of the exhaust or if you drive over something that strikes the underneath side of the vehicle, have the exhaust system checked as soon as possible by an authorized HYUNDAI dealer.

**Do not run the engine in an enclosed area.**

Letting the engine idle in your garage, even with the garage door open, is a hazardous practice. Run the engine only long enough to start the engine and to move the vehicle out of the garage.

**Avoid idling the engine for prolonged periods with people inside the vehicle.**

If it is necessary to idle the engine for a prolonged period with people inside the vehicle, be sure to do so only in an open area with the air intake set at "Fresh" and fan control set to high so fresh air is drawn into the interior.

**Keep the air intakes clear.**

To assure proper operation of the ventilation system, keep the ventilation air intakes located in front of the windshield clear of snow, ice, leaves, or other obstructions.

**If you must drive with the liftgate open:**

Close all windows.

Open instrument panel air vents.

Set the air intake control at "Fresh", the air flow control at "Floor" or "Face", and the fan control set to high.

**WARNING****CALIFORNIA PROPOSITION 65 WARNING**

**Engine exhaust and a wide variety of automobile components including components found in the interior furnishings in a vehicle, contain or emit harmful chemicals known to the State of California to cause cancer and birth defects and reproductive harm. In addition, certain fluids contained in vehicles and certain products of components contain or emit chemicals known to the State of California to cause cancer and birth defects or other reproductive harm.**



## BEFORE DRIVING

### Before Entering the Vehicle

- Be sure all windows, side view mirror(s), and outside lights are clean and unobstructed.
- Remove frost, snow, or ice.
- Visually check the tires for uneven wear and damage.
- Check under the vehicle for any sign of leaks.
- Be sure there are no obstacles behind you if you intend to back up.

### Before Starting

- Make sure the hood, the liftgate, and the doors are securely closed and locked.
- Adjust the position of the seat and steering wheel.
- Adjust the inside and outer side view mirrors.
- Verify all the lights work.
- Fasten your seat belt. Check that all passengers have fastened their seat belts.
- Check the gauges and indicators in the instrument panel and the messages on the instrument display when ignition switch or Engine Start/ Stop button is in the ON position.
- Check that any items you are carrying are stored properly or fastened down securely.



### WARNING

To reduce the risk of **SERIOUS INJURY** or **DEATH**, take the following precautions:

- **ALWAYS** wear your seat belt. All passengers must be properly belted whenever the vehicle is moving. For more information, refer to “Seat Belts” section in chapter 3.
- Always drive defensively. Assume other drivers or pedestrians may be careless and make mistakes.
- Stay focused on the task of driving. Driver distraction can cause accidents.
- Leave plenty of space between you and the vehicle in front of you.



### WARNING

**NEVER** drink or take drugs and drive.

Drinking or taking drugs and driving is dangerous and may result in an accident and **SERIOUS INJURY** or **DEATH**.

Drunk driving is the number one contributor to the highway death toll each year. Even a small amount of alcohol will affect your reflexes, perceptions and judgment. Just one drink can reduce your ability to respond to changing conditions and emergencies and your reaction time gets worse with each additional drink.

Driving while under the influence of drugs is as dangerous or more dangerous than driving under the influence of alcohol.

You are much more likely to have a serious accident if you drink or take drugs and drive. If you are drinking or taking drugs, don't drive. Do not ride with a driver who has been drinking or taking drugs. Choose a designated driver or call a taxi.

## IGNITION SWITCH

### WARNING

To reduce the risk of **SERIOUS INJURY** or **DEATH**, take the following precautions:

- **NEVER** allow children or any person who is unfamiliar with the vehicle to touch the ignition switch or related parts. Unexpected and sudden vehicle movement can occur.
- **NEVER** reach through the steering wheel for the ignition switch, or any other control, while the vehicle is in motion. The presence of your hand or arm in this area may cause a loss of vehicle control resulting in an accident.

### Key Ignition Switch (if equipped)



B0246EU02

Ⓐ: LOCK, Ⓑ: ACC  
Ⓒ: ON, Ⓓ: START

Whenever the front door is opened, the ignition switch will illuminate, provided the ignition switch is not in the ON position. The light will go off immediately when the ignition switch is turned on or go off after about 30 seconds when the door is closed. (if equipped)

### WARNING

- **NEVER** turn the ignition switch to the **LOCK** or **ACC** position while the vehicle is in motion except in an emergency.

This will result in the engine turning off and loss of power assist for the steering and brake systems. This may lead to loss of directional control and braking function, which could cause an accident.

- Before leaving the driver's seat, always make sure the shift button is in P (Park) position, apply the parking brake, and turn the ignition switch to the **LOCK** position.

Unexpected vehicle movement may occur if these precautions are not followed.

### **NOTICE**

Never use aftermarket keyhole covers. This may generate start-up failure due to communication failure.

**Key Ignition Switch Positions**

Switch Position	Action	Notes
<b>LOCK</b>	To turn the ignition switch to the LOCK position, push the key in at the ACC position and turn the key towards the LOCK position. The ignition key can be removed in the LOCK position. The steering wheel locks to protect the vehicle from theft. (if equipped)	
<b>ACC</b>	Some electrical accessories are usable. The steering wheel unlocks.	If difficulty is experienced turning the ignition switch to the ACC position, turn the key while turning the steering wheel right and left to release.
<b>ON</b>	This is the normal key position when the engine has started. All features and accessories are usable. The warning lights can be checked when you turn the ignition switch from ACC to ON.	Do not leave the ignition switch in the ON position when the engine is not running to prevent the battery from discharging.
<b>START</b>	To start the engine, turn the ignition switch to the START position. The switch returns to the ON position when you let go of the key.	The engine will crank until you release the key.

## Starting the Engine



### WARNING

- Always wear appropriate shoes when operating your vehicle. Unsuitable shoes, such as high heels, ski boots, sandals, flip-flops, etc., may interfere with your ability to use the brake, accelerator and clutch pedals.
  - Do not start the vehicle with the accelerator pedal depressed. The vehicle can move which can lead to an accident.
  - Wait until the engine RPM is normal. The vehicle may suddenly move if the brake pedal is released when the RPM is high.
1. Make sure the Electronic Parking Brake (EPB) is applied.
  2. Make sure the shift lever/button is in P (Park).
  3. Depress the brake pedal.
  4. Turn the ignition switch to the START position. Hold the key (maximum of 10 seconds) until the engine starts and release it.

### Information

- Do not wait for the engine to warm up while the vehicle remains stationary. Start driving at moderate engine speeds. (Steep accelerating and decelerating should be avoided.)
- Always start the vehicle with your foot on the brake pedal. Do not depress the accelerator while starting the vehicle. Do not race the engine while warming it up.

### NOTICE

To prevent damage to the vehicle:

- Do not hold the ignition key in the START position for more than 10 seconds. Wait 5 to 10 seconds before trying again.
- Do not turn the ignition switch to the START position with the engine running. It may damage the starter.
- If traffic and road conditions permit, you may put the shift button in the N (Neutral) position while the vehicle is still moving and turn the ignition switch to the START position in an attempt to restart the engine.
- Do not push or tow your vehicle to start the engine.

## Engine Start/Stop Button (if equipped)



Whenever the front door is opened, the Engine Start/Stop button will illuminate and will go off 30 seconds after the door is closed.

### WARNING

- To reduce risk of serious injury or death, **NEVER** allow children or any person who is unfamiliar with the vehicle to touch the Engine Start/Stop button or related parts. Unexpected and sudden vehicle movement can occur.

- To turn the vehicle off in an emergency:

Press and hold the Engine Start/Stop button for more than two seconds  
**OR** Rapidly press and release the Engine Start/Stop button three times (within three seconds).

If the vehicle is still moving, you can restart the vehicle without depressing the brake pedal by pressing the Engine Start/Stop button with the gear in the N (Neutral) position.

### WARNING

- **NEVER** press the Engine Start/Stop button while the vehicle is in motion except in an emergency. This will result in the vehicle turning off and loss of power assist for the steering and brake systems. This may lead to loss of directional control and braking function, which could cause an accident.
- Before leaving the driver's seat, always make sure the gear is in the P (Park) position, set the parking brake, press the Engine Start/Stop button to the OFF position, and take the Smart Key with you. Unexpected vehicle movement may occur if these precautions are not followed.
- **NEVER** reach through the steering wheel for the Engine Start/Stop button or any other control while the vehicle is in motion. The presence of your hand or arm in this area may cause a loss of vehicle control resulting in an accident.

## Engine Stop/Start Button Positions

Button Position	Action	Notes
<b>OFF</b>	To turn off the engine, press the Engine Start/Stop button with the vehicle shifted to P (Park). Note if the Engine Start/Stop button is pressed with the vehicle shifted to D (Drive) or R (Reverse), the gear will automatically shift to P (Park). If the Engine Start/Stop button is pressed with the gear shifted to N (Neutral), the Engine Start/Stop button will change to the ACC position.	
<b>ACC</b>	Press the Engine Start/Stop button when the button is in the OFF position without depressing the brake pedal. Some of the electrical accessories are usable.	If you leave the Engine Start/Stop button in the ACC position for more than one hour, the battery power will turn off automatically to prevent the battery from discharging.
<b>ON</b>	Press the Engine Start/Stop button while it is in the ACC position without depressing the brake pedal. The warning lights can be checked before the engine is started.	Do not leave the Engine Start/Stop button in the ON position when the engine is not running to prevent the battery from discharging.
<b>START</b>	To start the engine, depress the brake pedal and press the Engine Start/ Stop button with the gear shifted to the P (Park) or the N (Neutral) position. For your safety, start the engine with the gear shifted to the P (Park) position.	If you press the Engine Start/Stop button without depressing the brake pedal, the engine does not start and the Engine Start/Stop button changes as follows: <b>OFF → ACC → ON → OFF</b>

### Information

To prevent vehicle battery discharge, the Engine Start/Stop button changes to the OFF position when the Engine Start/Stop button is in the ACC or ON position with the gear in P (Park) for a certain period of time. When the function operates, the tail lamps will turn off. To use the tail lamps again, turn the headlight switch located on the steering column to the OFF and ON position again.

## Starting the Engine



### WARNING

- **Always wear appropriate shoes when operating your vehicle. Unsuitable shoes, such as high heels, ski boots, sandals, flipflops, etc., may interfere with your ability to use the brake and accelerator pedals.**
- **Do not start the vehicle with the accelerator pedal depressed. The vehicle can move which can lead to an accident.**
- **Wait until the engine RPM is normal. The vehicle may suddenly move if the brake pedal is released when the RPM is high.**



### Information

- The vehicle will start by pressing the Engine Start/Stop button, only when the smart key is in the vehicle.
- Even if the smart key is in the vehicle, and when it is far away from the driver, the engine may not start.
- When the Engine Start/Stop button is in the ACC or ON position, if any door is open, the system checks for the smart key. When the smart key is not in the vehicle, the “” indicator will blink and the warning 'Key not in vehicle' will come on. When all doors are closed, the chime will also sound for about 5 seconds. Keep the smart key in the vehicle.

1. Always carry the smart key with you.
2. Make sure the parking brake is applied.
3. Make sure the gear is shifted to P (Park) by pressing the P button.
4. Depress the brake pedal.
5. Press the Engine Start/Stop button.



### Information

- **Do not wait for the engine to warm up while the vehicle remains stationary. Start driving at moderate engine speeds. Steep accelerating and decelerating should be avoided.**
- **Always start the vehicle with your foot on the brake pedal. Do not depress the accelerator while starting the vehicle. Do not race the engine while warming it up.**

**NOTICE**

To prevent damage to the vehicle:

- If the engine stalls while you are in motion, do not attempt to shift the gear to the P (Park) position.  
If traffic and road conditions permit, you may put the gear in N (Neutral) while the vehicle is still moving and press the Engine Start/Stop button in an attempt to restart the engine.
- Do not push or tow your vehicle to start the vehicle.

**NOTICE**

To prevent damage to the vehicle:

Do not press the Engine Start/Stop button for more than 10 seconds except when the stop lamp fuse is blown.

When the stop lamp fuse is blown, you cannot normally start the engine. Replace the fuse with a new one. If you are not able to replace the fuse, you can start the engine by pressing and holding the Engine Start/Stop button for 10 seconds with the Engine Start/Stop button in the ACC position.

For your safety always depress the brake pedal before starting the vehicle.

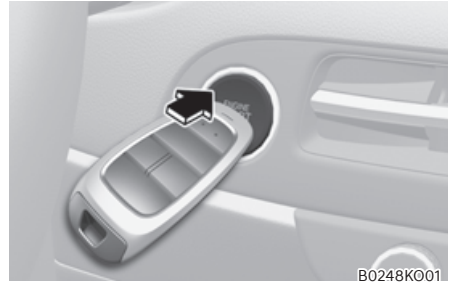
**Emergency Starting**

If the smart key battery is weak or the smart key does not work correctly, you can start the vehicle by pressing the Engine Start/Stop button with the smart key in the direction of the picture above.

**Turning Off the Engine**

1. Stop the vehicle and depress the brake pedal fully.
2. Press the P button to shift to P (Park).
3. Press the Engine Start/Stop button to the OFF position and apply the parking brake.



**Remote Start (if equipped)**

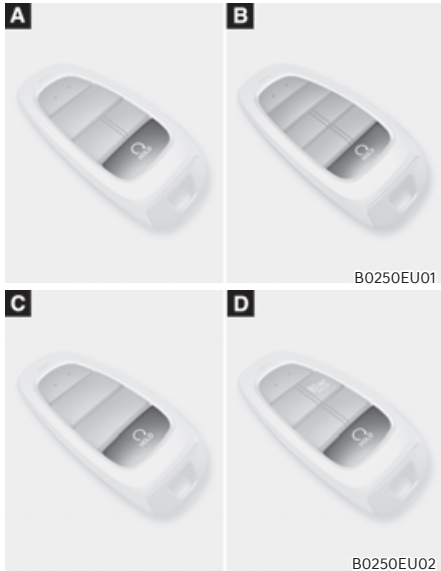

You can start the vehicle using the Remote Start button of the smart key.

To start the vehicle remotely:

1. Press the door lock button within 32 ft. (10 m) from the vehicle.
  2. Press the remote start ( $\text{Ⓞ}_{\text{HOLD}}$ ) button for over 2 seconds within 4 seconds after locking the doors. The hazard warning lights will blink.
  3. To turn off the remote start function, press the remote start ( $\text{Ⓞ}_{\text{HOLD}}$ ) button once.
- The remote start ( $\text{Ⓞ}_{\text{HOLD}}$ ) button may not operate if the smart key is not within 32 ft. (10 m).
  - The vehicle will not remotely start if the engine hood or liftgate is opened.
  - The vehicle must be in P (Park) for the remote start function to start.
  - The engine turns off if you get in the vehicle without a registered smart key.
  - The engine turns off if you do not get in the vehicle within 10 minutes after remotely starting the vehicle.
  - Do not idle the engine for a long period.

## VEHICLE AUTO-SHUT OFF (IF EQUIPPED)

If your vehicle is parked and the engine is left on for a long period of time, the engine will turn off automatically to help reduce fuel consumption and prevent accidents caused by carbon dioxide poisoning.

### Operating Conditions

Vehicle Auto-Shut Off timer operates when all the following conditions are satisfied:

- Vehicle speed is below 1.8 mph (3 km/h), and the gear is shifted to P (Park)
- The brake pedal and accelerator pedal are not depressed
- The driver's seat belt is unfastened
- The passenger seat is empty
- The infotainment system is being updated

### Deactivating Conditions

Vehicle Auto-Shut Off timer turns off when one of the situation occur:

- Vehicle speed is above 1.8 mph (3 km/h)
- The gear is shifted to R (Reverse), D (Drive) or N (Neutral)
- The brake pedal or accelerator pedal is depressed
- The driver's seat belt is fastened
- A passenger is in the passenger's seat

### System Operation

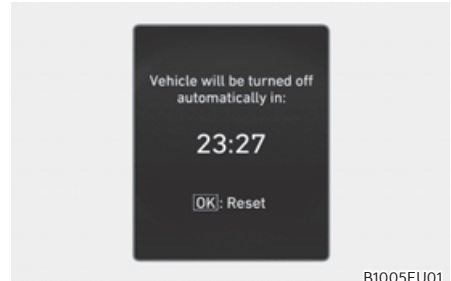

B1005EU01

When all the conditions are satisfied, the Vehicle Auto-Shut Off operates and turns the engine off automatically after 60 minutes.

A timer appears on the instrument cluster 30 minutes before vehicle shut off.

### Resetting cluster timer

To reset the cluster timer, do one of following:

- Release the accelerator pedal or brake pedal after Vehicle Auto-Shut Off is complete.
- Press the OK button on the steering wheel while the timer appears on the instrument cluster.



### CAUTION

**Do not leave a passenger or a pet in the vehicle in hot weather since the air conditioning system turns off when the engine is off.**

## AUTOMATIC TRANSMISSION



Depress the brake pedal whenever pressing the shift button to change gear or shifting P.

A0251K001

### Automatic Transmission Operation

The automatic transmission has eight forward speeds and one reverse speed. The individual speeds are selected automatically in the D (Drive) position.



#### **WARNING**

The automatic transmission shift button or interior parts might get hot when a vehicle is parked out-side during hot weather. Always be careful when the vehicle is hot.

## WARNING

To reduce the risk of serious injury or death:

- **ALWAYS** check the surrounding areas near your vehicle for people, especially children, before shifting a vehicle into D (Drive) or R (Reverse).
- Before leaving the driver's seat, always make sure the vehicle is shifted to the P (Park) position, then apply the parking brake, then place the ignition switch or press the Engine Start/Stop button to the LOCK/OFF position. Unexpected and sudden vehicle movement can occur if these precautions are not followed.
- When using the paddle shifter (manual shift mode), do not use engine braking (shifting from a high gear to lower gear) rapidly on slippery roads. The vehicle may slip causing an accident.

## Transmission ranges

### P (Park)

Always come to a complete stop before shifting into P (Park).

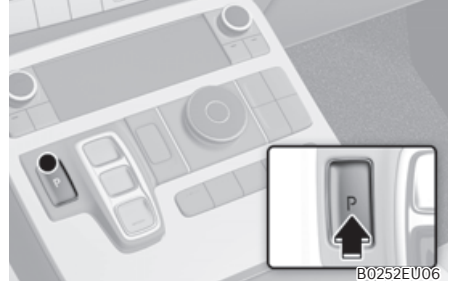

To shift the gear to P (Park), press the P button while depressing the brake pedal.

If you turn the engine off in R (Reverse), N (Neutral) or D (Drive), the gear will automatically shift to P (Park).

## WARNING

- Shifting into P (Park) while the vehicle is in motion may cause you to lose control of the vehicle.
- After the vehicle has stopped, always make sure the vehicle is in P (Park), apply the parking brake, and turn the engine off.
- When parking on an incline, shift the gear to P (Park) and apply the parking brake to prevent the vehicle from rolling downhill.

### Automatic gear shift to P (Park)

The gear is shifted to P (Park) automatically for safety reasons under the following conditions:

- When the engine is turned off with the gear in R (Reverse), D (Drive) or N (Neutral).
- When the driver's door is open with the engine running, the gear in R (Reverse), D (Drive) or N (Neutral), the seat belt unfastened and the vehicle at a standstill.
- When the driver's or front passenger's door is open with the gear in N (Neutral) and the vehicle is off.

In situations the gear must be in P (Park), always check if the gear is shifted to P (Park) by checking the cluster.

### R (Reverse)

Use this position to drive the vehicle rearward.

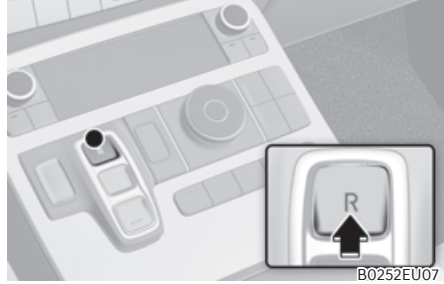

To shift the gear R (Reverse), press the R button while depressing the brake pedal.

When the vehicle is stopped in the R (Reverse) position, if you open the driver's door with the seat belt unfastened, the gear will automatically shift to P (Park).

However, if the vehicle is in motion, the gear may not automatically shift to P (Park) to prevent automatic transmission damage.

### **NOTICE**

**Always come to a complete stop before shifting into or out of R (Reverse); you may damage the transmission if you shift into R (Reverse) while the vehicle is in motion.**

## N (Neutral)

The wheels and transmission are not engaged.

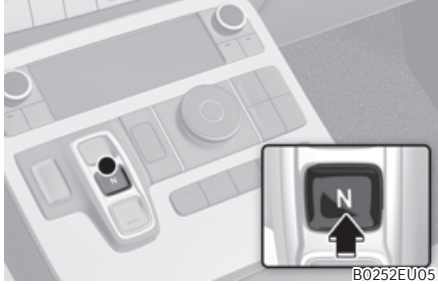

To shift the gear to N (Neutral), press the N button from R (Reverse) or D (Drive) while depressing the brake pedal.

Always depress the brake pedal when you are shifting from N (Neutral) to another gear.

If you turn the engine off in N (Neutral), the gear will automatically shift to P (Park).

However, if you need to stay in N (Neutral) with the engine off, refer to “To stay in N (Neutral) when vehicle is OFF”.



### CAUTION

**The engine can be started with the gear in N (Neutral), but for your safety, be sure to start the engine with the gear in P (Park).**

## To stay in N (Neutral) when vehicle is OFF

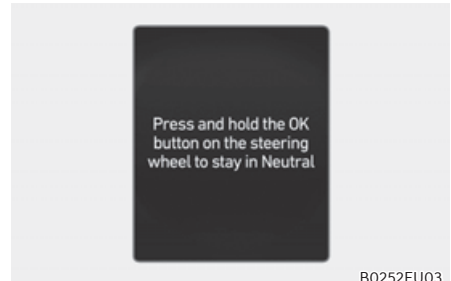

If you want to stay in N (Neutral) after the engine is OFF (in the ACC state), do the following.

1. Turn off Auto Hold and release Electronic Parking Brake when the engine is running.
2. Press the shift button to N (neutral) while depressing the brake pedal.
3. When you take your foot off the brake pedal, the message ‘Press and hold the OK button on the steering wheel to stay in Neutral’ will appear on the cluster LCD display.

4. Press and hold the OK button (A) on the steering wheel for more than 1 second.
5. When the message 'Vehicle will stay in (N). Change gear to cancel' appears on the cluster LCD display, press the ignition switch or Engine Start/Stop button while depressing the brake pedal.

If you wish to cancel, change gear to P (Park), D (Drive) or R (Reverse), or N (Neutral) will stay engaged when the vehicle is Off.

Also, if you open the driver's door, the gear will automatically shift to P (Park) and the ignition switch or Engine Start/Stop button will change to the LOCK/OFF position.

### NOTICE

**With the gear in N (Neutral) the ignition switch or Engine Start/Stop button will be in the ACC position. In the ACC position, the doors cannot be locked. The battery may discharge if left in the ACC position for a long time.**

### D (Drive)

This is the normal driving position.

The transmission will automatically shift through an 8-gear sequence, providing the best fuel economy and power.

For extra power when passing another vehicle or driving uphill, depress the accelerator pedal further until you feel the transmission downshift to a lower gear.

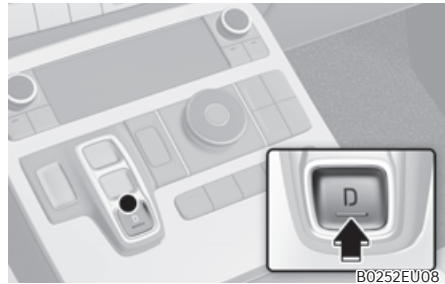

To shift the gear D (Drive), press the D button while depressing the brake pedal.

When the vehicle is stopped in the D (Drive) position, if you open the driver's door with the seat belt unfastened, the gear will automatically shift to P (Park).

However, if the vehicle is in motion, the gear may not automatically shift to P (Park) to prevent automatic transmission damage.

### NOTICE

**Always come to a complete stop before shifting into D (Drive).**



### CAUTION

**When you start after stopping on a steep incline, even if the gear is in D (Drive), if you do not depress the accelerator or brake pedal, the vehicle may roll backwards, which can cause an accident.**

***When the battery is discharged***

You cannot shift gears, when the battery is discharged.

In emergencies, do the following to shift the gear to N (Neutral) on a level ground.

1. Connect the battery cables from another vehicle or from another battery to the jump-starting terminals inside the engine compartment.  
For more details, refer to "Jump Starting" section in chapter 8.
2. Release the Electronic Parking Brake with the ignition switch or Engine Start/Stop button in the ON position.
3. Shift the gear to the N (Neutral) position. Refer to the "To stay in N (Neutral) when vehicle is Off" in this chapter.

 **Information**

**In situations when the gear needs to be shifted from P (Park) to N (Neutral) when the ignition switch or Engine Start/Stop button is in the OFF position, refer to the "To stay in N (Neutral) when vehicle is OFF" in this chapter.**

***Shift-lock system***

For your safety, the automatic transmission has a shift-lock system which prevents shifting the transmission from P (Park) into R (Reverse) or D (Drive) unless the brake pedal is depressed.

To shift from P (Park) or N (Neutral) into R (Reverse) or D (Drive):

1. Depress and hold the brake pedal.
2. Start the engine.
3. Shift gear while depressing the brake pedal.

***Ignition key interlock system (if equipped)***

The ignition key cannot be removed unless the shift button is in the P (Park) position.



### Parking

Always come to a complete stop and continue to depress the brake pedal.

Shift the gear to P (Park), apply the parking brake, and place the ignition switch or press the Engine Start/Stop button to the OFF position.

Take the Key with you when leaving the vehicle.



### WARNING

- **When you stay in the vehicle with the engine running, be careful not to depress the accelerator pedal for a long period of time. The engine or exhaust system may overheat and start a fire.**
- **The exhaust gas and the exhaust system are very hot. Keep away from the exhaust system components.**
- **Do not stop or park over flammable materials, such as dry grass, paper or leaves. They may ignite and cause a fire.**

### LCD Display Messages (Cluster)

#### **Press brake pedal to change gear**

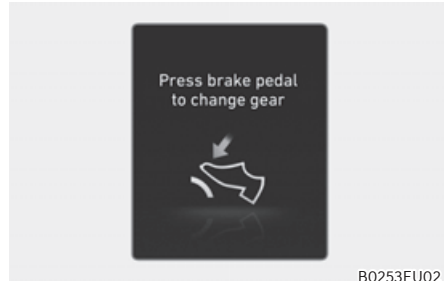

This message is displayed when the brake pedal is not depressed while shifting the gear.

Depress the brake pedal and then shift the gear.

#### **Shift to P after stopping**

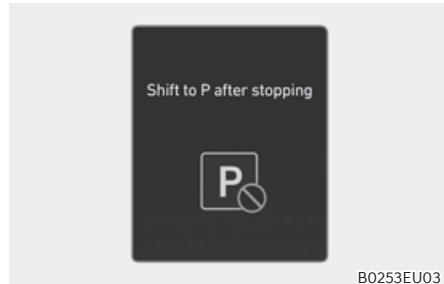

This message is displayed when the gear is shifted to P (Park) while the vehicle is moving.

Stop the vehicle before shifting to P (Park).

**Shifting conditions not met**

This message is displayed when engine RPM is too high, or when driving speed is too fast to shift the gear.

Decrease vehicle speed or slow down before shifting the gear.

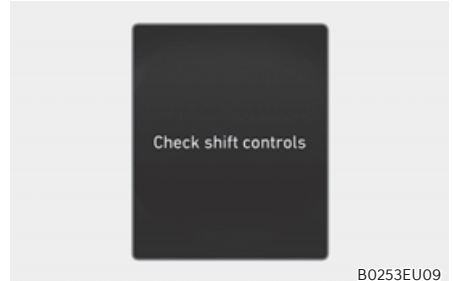
**Check shift controls**

This message is displayed when there is a malfunction with the shift button.

Immediately have the vehicle inspected by an authorized HYUNDAI dealer.

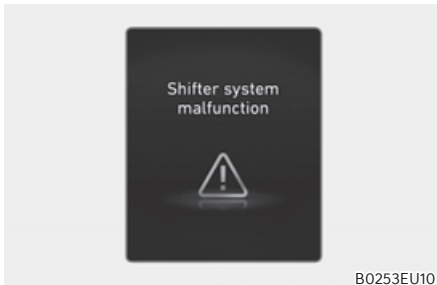
**Shifter system malfunction**

This message is displayed when the transmission or the shift button does not properly operate in the P (Park) position.

Immediately have the vehicle inspected by an authorized HYUNDAI dealer.

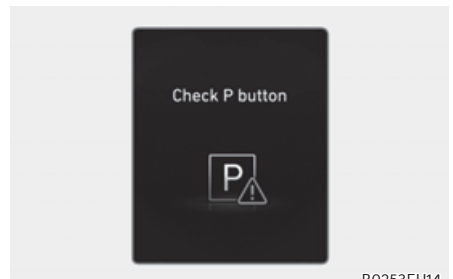
**Check P button**

This message is displayed when there is a problem with the P button.

Immediately have the vehicle inspected by an authorized HYUNDAI dealer.

***Gear already selected***

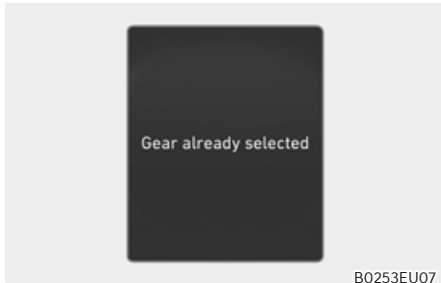

B0253EU07

This message is displayed when pushing the current shift button again.

***PARK malfunction. Engage parking brake when parking vehicle***

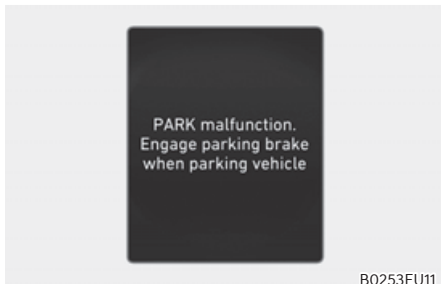

B0253EU11

This message is displayed when there is a fault with the Parking brake. Immediately have the vehicle inspected by an authorized HYUNDAI dealer.

***Avoid shifting for a few seconds***

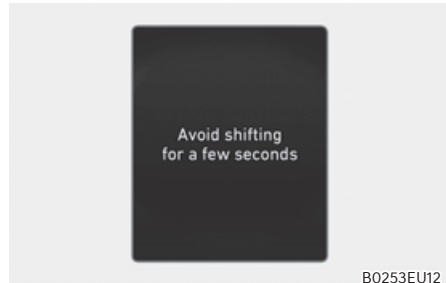

B0253EU12

This message is displayed when pressing the transmission buttons frequently. Press the transmission button after a few seconds.

***PARK engaged***

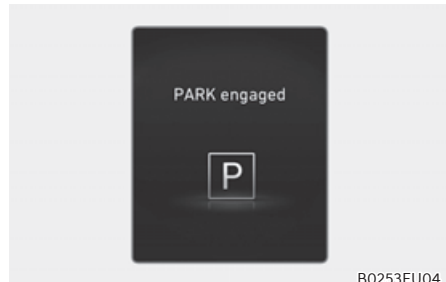

B0253EU04

This message is displayed when the P (PARK) position is engaged. Make sure that the vehicle is completely stopped before shifting to P (Park).

### **Turn engine On to change gear (if equipped)**

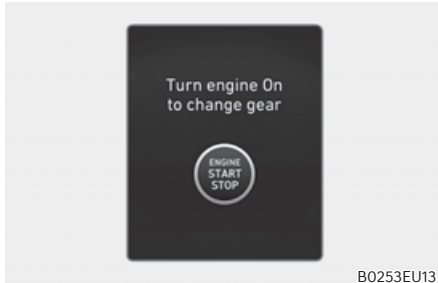

The message is displayed when the engine is off or battery level is low.

### **Vehicle will stay in (N). Change gear to cancel**

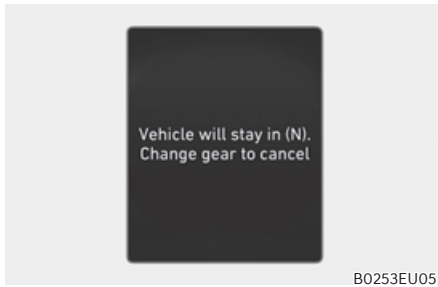

This message is displayed when pushing the "OK" button on the steering wheel after the message 'Press and hold the OK button on the steering wheel to stay in Neutral' appears on the cluster LCD display. The gear stays in N(Neutral) position after turning off the engine.

### **NEUTRAL engaged**

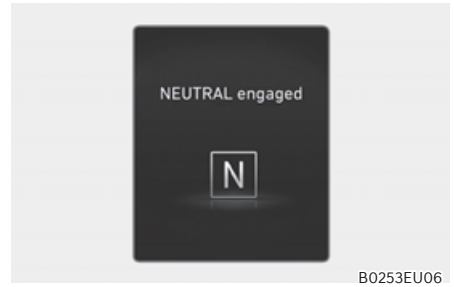

This message is displayed when the N (Neutral) position is engaged.

### **Shift button held down**



When the shift button is pressed continuously or the shift button does not properly operate. Clean the surroundings of gear shift button.

Immediately have the vehicle inspected by an authorized HYUNDAI dealer.

### Transmission overheated warning

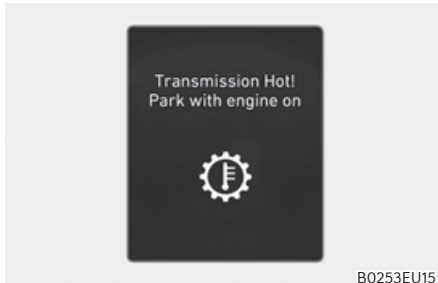

#### Transmission Hot! Park with engine on

Repeated sudden acceleration and quick start may overheat the transmission. If the transmission is overheated, the self protection mode alarms the driver with an audible sound warning message.

Move the vehicle to a safe location and shift the gear to 'P' (parking), and stop the vehicle with the engine on. Wait until the transmission is sufficiently cooled down.



#### Vehicle Power limited due to high transmission temperature

If you continue to drive with overheated transmission, the above warning message is displayed and self-protection mode restricts the power output of the vehicle.

- Move the vehicle to a safe location and shift the gear to P (Park), and stop the vehicle with the engine on. Wait until the transmission is sufficiently cooled down.
- If the above message is continuously displayed, we recommend that you contact an authorized authorized HYUNDAI dealer.

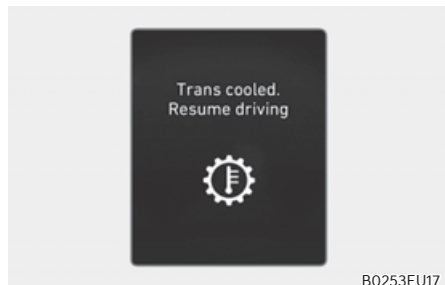

#### Trans cooled. Resume driving

This message is displayed when the vehicle is safe to drive.

## Paddle Shifter (Manual Shift Mode)



The paddle shifter is available when the gear is in the D (Drive) position.

Pull the [+] or [-] paddle shifter once to shift up or down one gear and the system changes from automatic shift mode to manual shift mode.

To change back to automatic shift mode from manual shift mode, do one of the followings:

- Pull and hold the [+] paddle shifter.
- Push the shift button D (Drive).

The manual shift mode also changes back to automatic shift mode in one of following situations:

- When the accelerator pedal is gently depressed for more than 6 seconds while driving.
- When the vehicle speed decreases below 4 mph (7 km/h).

### **i** Information

**If the [+] and [-] paddle shifters are pulled at the same time, gear shift may not occur.**

## Good Driving Practices

- Never shift the gear from P (Park) or N (Neutral) to any other position with the accelerator pedal depressed.
- Never shift the gear into P (Park) when the vehicle is in motion.

Be sure the vehicle is completely stopped before you attempt to shift into R (Reverse) or D (Drive).

- Do not shift the gear to N (Neutral) when driving. If the gear is shifted to N (Neutral) while driving, the vehicle loses the ability to provide engine braking. Doing so may increase the risk of an accident.

Also, shifting the gear back to D (Drive) while the vehicle is moving may severely damage the transmission.

- When driving uphill or downhill, always shift to D (Drive) for driving forward or shift to R (Reverse) for driving rearwards. After selecting D (Drive) or R (Reverse), check the gear position indicated on the cluster before driving. If the vehicle moves in the opposite direction of the selected gear, the engine may turn off and affect braking performance that may lead to a serious accident.
- Do not drive with your foot resting on the brake pedal. Even light, but consistent pedal pressure can result in the brakes overheating, brake wear and possibly even brake failure.

- When driving in manual mode, slow down before shifting to a lower gear. Otherwise, the lower gear may not be engaged if the engine RPMs are outside of the allowable range.
- Always apply the parking brake when leaving the vehicle. Do not depend on placing the transmission in P (Park) to keep the vehicle from moving.
- Exercise extreme caution when driving on a slippery surface. Be especially careful when braking, accelerating or shifting gears. On a slippery surface, an abrupt change in vehicle speed can cause the drive wheels to lose traction and may cause loss of vehicle control resulting in an accident.
- Optimum vehicle performance and economy is obtained by smoothly depressing and releasing the accelerator.



### **WARNING**

To reduce the risk of **SERIOUS INJURY** or **DEATH**:

- **ALWAYS wear your seat belt. In a collision, an unbelted occupant is significantly more likely to be seriously injured or killed than a properly belted occupant.**
- **Avoid high speeds when cornering or turning.**
- **Do not make quick steering wheel movements, such as sharp lane changes or fast, sharp turns.**
- **The risk of rollover is greatly increased if you lose control of your vehicle at highway speeds.**
- **Loss of control often occurs if two or more wheels drop off the roadway and the driver over steers to reenter the roadway.**
- **In the event your vehicle leaves the roadway, do not steer sharply. Instead, slow down before pulling back into the travel lanes.**
- **HYUNDAI recommends you follow all posted speed limits.**

## BRAKING SYSTEM

### Power-Assist Brakes

Your vehicle has power-assisted brakes that adjust automatically through normal usage.

If the engine is not running or is turned off while driving, the power assist for the brakes will not work. You can still stop your vehicle by applying greater force to the brake pedal than typical. The stopping distance, however, will be longer than with power brakes.

When the engine is not running, the reserve brake power is partially depleted each time the brake pedal is applied. Do not pump the brake pedal when the power assist has been interrupted.



### WARNING

Take the following precautions:

- **Do not drive with your foot resting on the brake pedal. This will create abnormal high brake temperatures, excessive brake lining and pad wear, and increased stopping distances.**
- **When descending down a long or steep hill, use the paddle shifter and manually downshift to a lower gear in order to control your speed without using the brake pedal excessively. Applying the brakes continuously will cause the brakes to overheat and could result in a temporary loss of braking performance.**

- **Wet brakes may impair the vehicle's ability to safely slow down; the vehicle may also pull to one side when the brakes are applied. Applying the brakes lightly will indicate whether they have been affected in this way. Always test your brakes in this fashion after driving through deep water. To dry the brakes, lightly tap the brake pedal to heat up the brakes while maintaining a safe forward speed until brake performance returns to normal. Avoid driving at high speeds until the brakes function correctly.**

### Disc Brakes Wear Indicator

When your brake pads are worn and new pads are required, you will hear a high pitched warning sound from your front or rear brakes. You may hear this sound come and go or it may occur whenever you depress the brake pedal.

Note that some driving conditions or climates may cause a brake squeal when you first apply (or lightly apply) the brakes. This is normal and does not indicate a problem with your brakes.

### NOTICE

**To avoid costly brake repairs, do not continue to drive with worn brake pads.**



### Information

**Always replace brake pads as complete front or rear axle sets.**



## Electronic Parking Brake (EPB)

### Applying the parking brake



To apply EPB (Electronic Parking Brake):

1. Depress and hold the brake pedal.
2. Pull up the EPB switch.

Make sure the Parking Brake warning light comes on.

EPB (Electronic Parking Brake) may be automatically applied when:

- Requested by other systems
- The driver turns the vehicle off while Auto Hold is operating.

### Emergency braking

If there is a problem with the brake pedal while driving, emergency braking is possible by pulling up and holding the EPB switch. Braking is possible only while you are holding the EPB switch. However, braking distance will be longer than normal.

### WARNING

To reduce the risk of **SERIOUS INJURY** or **DEATH**, do not operate the EPB while the vehicle is moving except in an emergency situation. It could damage the brake system and lead to an accident.

### Information

During emergency braking, the Parking Brake warning light will illuminate to indicate that the system is operating.

### **NOTICE**

If you continuously notice a noise or burning smell when the EPB is used for emergency braking, have the system checked by an authorized HYUNDAI dealer.

## Releasing the parking brake



### To release EPB (Electronic Parking Brake):

1. Place the ignition switch or press the Engine Start/Stop button to the ON or START position.
2. Press the EPB switch while depressing the brake pedal.

Make sure the Parking Brake warning light goes off.

### To release EPB (Electronic Parking Brake) automatically:

- Gear in P (Park)  
With the engine running depress the brake pedal and shift out of P (Park) to R (Reverse) or D (Drive).
- Gear in N (Neutral)  
With the engine running depress the brake pedal and shift out of N (Neutral) to R (Reverse) or D (Drive).

- Satisfy the following conditions
1. Ensure seat belts are fastened and the doors, hood and liftgate are closed.
  2. With the engine running, depress the brake pedal and shift out of P (Park) to R (Reverse), D (Drive) or Manual shift mode.
  3. Depress the accelerator pedal.  
Make sure the Parking Brake warning light goes off.

## **i** Information

- **For your safety, you can engage EPB even though the ignition switch is in the LOCK/OFF position (only if battery power is available), but you cannot release it.**
- **For your safety, depress the brake pedal and release the parking brake manually with the EPB switch when you drive downhill or when backing up the vehicle.**

## **NOTICE**

- **If the Parking Brake warning light is still on even though the EPB has been released, have the system checked by an authorized HYUNDAI dealer.**
- **Do not drive your vehicle with EPB applied. It may cause excessive brake pad and brake rotor wear.**

## Warning messages

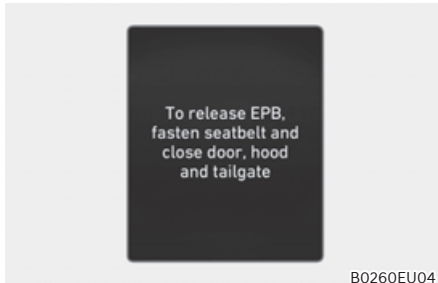

### To release EPB, fasten seatbelt and close door, hood and liftgate

- If you try to drive with EPB applied, a warning will sound and a message will appear.
- If the driver's seat belt is unfastened and the engine hood or liftgate is opened, a warning will sound and a message will appear.
- If there is a problem with the vehicle, a warning may sound and a message may appear.

If the situation occurs, depress the brake pedal and release EPB by pressing the EPB switch.

## WARNING

- Whenever leaving the vehicle or parking, always come to a complete stop and continue to depress the brake pedal.

Shift the gear into P (Park), pull the EPB switch, and place the ignition switch or press the Engine Start/ Stop button to the OFF position. Take the Key with you when leaving the vehicle.

Vehicles not fully engaged in P (Park) with the parking brake set are at risk for moving inadvertently and causing injury to yourself or others.

- **NEVER** allow anyone who is unfamiliar with the vehicle to touch the EPB switch. If EPB is released unintentionally, serious injury may occur.
- **Only** release EPB when you are seated inside the vehicle with your foot firmly on the brake pedal.

**NOTICE**

- Do not apply the accelerator pedal while the parking brake is engaged. If you depress the accelerator pedal with EPB engaged, a warning will sound and a message will appear. Damage to the parking brake may occur.
- Driving with the parking brake on can overheat the braking system and cause premature wear or damage to brake parts. Make sure EPB is released and the Parking Brake warning light is off before driving.

**i Information**

- A clicking sound may be heard while operating or releasing the EPB. These conditions are normal and indicate that EPB is functioning properly.
- When leaving your keys with a parking attendant or assistant, make sure to inform him/her how to operate EPB.

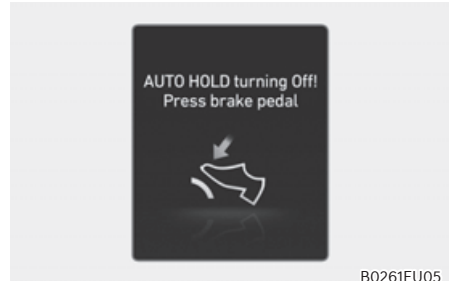

B0261EU05

**AUTO HOLD turning Off! Press brake pedal**

When the conversion from Auto Hold to EPB is not working properly a warning will sound and a message will appear.

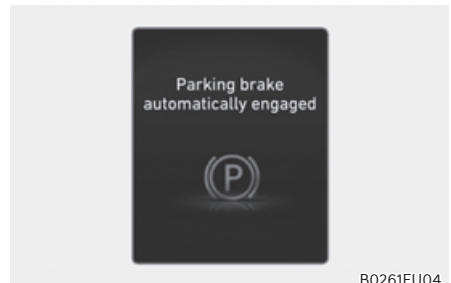

B0261EU04

**Parking brake automatically engaged**

When EPB is applied while Auto Hold is activated, a warning will sound and a message will appear.

### **EPB malfunction**

Electronic Parking Brake (EPB) warning light illuminates if the ignition switch placed or Engine Start/Stop button is pressed to the ON position and goes off in approximately 3 seconds if the system is operating normally.

If the EPB warning light remains on, comes on while driving, or does not come on when the ignition switch or Engine Start/Stop button is placed to the ON position, this indicates that the EPB may have malfunctioned.

If this occurs, have the system checked by an authorized HYUNDAI dealer.

The EPB warning light may illuminate when the ESC indicator comes on to indicate that ESC is not working properly, but it does not indicate a malfunction of EPB.

#### **NOTICE**

- **If the EPB warning light is still on, have the system checked by an authorized HYUNDAI dealer.**
- **If the Parking Brake warning light does not illuminate or blinks even though the EPB switch was pulled up, EPB may not be applied.**
- **If the Parking Brake warning light blinks when the EPB warning light is on, press the switch, and then pull it up. Repeat this one more time. If the EPB warning does not go off, have the system checked by an authorized HYUNDAI dealer.**

### **Parking brake warning light**



Check the Parking Brake warning light by pressing the Engine Stop/Start button to the ON position.

This light will be illuminated when the parking brake is applied with the ignition switch or Engine Stop/Start button in the START or ON position.

Before driving, be sure the parking brake is released and the Parking Brake warning light is OFF.

If the Parking Brake warning light remains on after the parking brake is released while the engine is running, there may be a malfunction in the brake system. Immediate attention is necessary.

If at all possible, cease driving the vehicle immediately. If that is not possible, use extreme caution while operating the vehicle and only continue to drive the vehicle until you can reach a safe location.

#### **When the EPB (Electronic Parking Brake) does not release**

If the EPB does not release normally, contact an authorized HYUNDAI dealer by loading the vehicle on a flatbed tow truck and have the system checked.

## Auto Hold

Auto Hold helps maintain the vehicle in a standstill even though the brake pedal is not depressed after the driver brings the vehicle to a complete stop by depressing the brake pedal.

### **i** Information

**The Auto Hold On or Off setting is maintained when the vehicle is turned off. When the vehicle is restarted the last setting for Auto Hold is applied.**

#### **To apply:**



①: White

1. With the driver's door and engine hood closed, depress the brake pedal and then press the AUTO HOLD switch. The white AUTO HOLD indicator will come on and the system will be in the standby position.

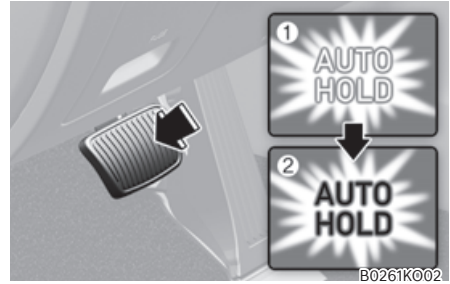

①: White, ②: Green

2. When you stop the vehicle completely by depressing the brake pedal, Auto Hold maintains the brake pressure to hold the vehicle stationary. The indicator changes from white to green.
3. The vehicle will remain stationary even if you release the brake pedal.
4. If EPB is applied, Auto Hold will be released.

#### **To release:**

If you depress the accelerator pedal with the gear in D (Drive), R (Reverse) or Manual shift mode, the Auto Hold will be released automatically and the vehicle will start to move. The AUTO HOLD indicator changes from green to white.

**⚠ WARNING**

When Auto Hold is automatically released by depressing the accelerator pedal, always take a look around your vehicle.

Slowly depress the accelerator pedal for a smooth start.

**To cancel:**



①: Light off

1. Depress and hold the brake pedal.
  2. Press the AUTO HOLD switch.
- The AUTO HOLD indicator will turn off.

**⚠ WARNING**

To prevent, unexpected and sudden vehicle movement, **ALWAYS** press your foot on the brake pedal to cancel the Auto Hold before you:

- Drive downhill.
- Drive the vehicle in R (Reverse).
- Park the vehicle.

**i Information**

- The Auto Hold does not operate when:
  - The driver's door is opened
  - The engine hood is opened
  - The gear is in P (Park)
  - EPB is applied
- For your safety, the Auto Hold automatically switches to EPB when:
  - The driver's door is opened
  - The engine hood is opened
  - The vehicle is in a standstill for more than 10 minutes
  - The vehicle is standing on a steep slope
  - The vehicle moved several times

In these cases, the Parking Brake warning light comes on, the AUTO HOLD indicator changes from green to white, and a warning sound and a message will appear to inform you that EPB has been automatically engaged. Before driving off again, depress the brake pedal, check the surrounding area near your vehicle and release the parking brake manually with the EPB switch.

- While operating Auto Hold, you may hear mechanical noise. However, it is normal operating noise.

**NOTICE**

If the AUTO HOLD indicator changes to yellow, Auto Hold is not working properly. Contact an authorized HYUNDAI dealer.



## WARNING

- Depress the accelerator pedal slowly when you start the vehicle.
- For your safety, cancel Auto Hold when you drive downhill, back up the vehicle or park the vehicle.

## NOTICE

If there is a malfunction with the driver's door or engine hood open detection system, Auto Hold may not work properly.

Contact an authorized HYUNDAI dealer.

### Warning messages

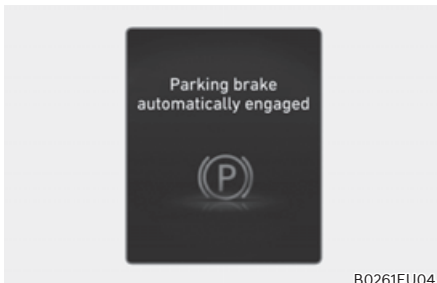

#### Parking brake automatically engaged

When EPB is applied while Auto Hold is activated, a warning will sound and a message will appear.

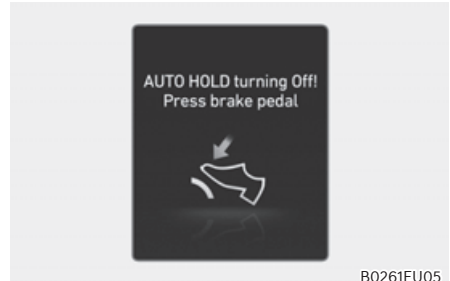

#### AUTO HOLD turning Off! Press brake pedal

When the conversion from Auto Hold to EPB is not working properly a warning will sound and a message will appear.

When this message is displayed, Auto Hold and EPB may not operate. For your safety, depress the brake pedal.

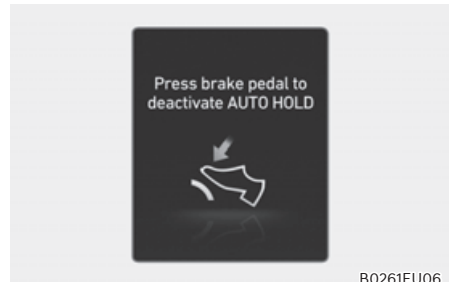

#### Press brake pedal to deactivate AUTO HOLD

If you did not apply the brake pedal when you release Auto Hold by pressing the AUTO HOLD switch, a warning will sound and a message will appear.





**AUTO HOLD conditions not met.  
Close door and hood.**

When you press the AUTO HOLD switch, if the driver's door and engine hood are not closed, a warning will sound and a message will appear on the cluster LCD display.

Press the AUTO HOLD switch after closing the driver's door and hood.

## Anti-Lock Brake System (ABS)

 **WARNING**

Anti-Lock Braking System (ABS) or Electronic Stability Control (ESC) system will not prevent accidents due to improper or dangerous driving maneuvers. Even though vehicle control is improved during emergency braking, always maintain a safe distance between you and objects ahead of you. Vehicle speeds should always be reduced during extreme road conditions. The braking distance for vehicles equipped with ABS or ESC may be longer than for those without these systems in the following road conditions.

**Drive your vehicle at reduced speeds during the following conditions:**

- Rough, gravel or snow-covered roads.
- On roads where the road surface is pitted or has different surface height.
- Tire chains are installed on your vehicle.

**The safety features of ABS or ESC equipped vehicle should not be tested by high speed driving or cornering. This could endanger the safety of yourself or others.**

ABS is an electronic braking system that helps prevent a braking skid. ABS allows the driver to steer and brake at the same time.

## Using ABS

To obtain the maximum benefit from your ABS in an emergency situation, do not attempt to modulate your brake pressure and do not try to pump your brakes. Depress your brake pedal as hard as possible.

When you apply your brakes under conditions which may lock the wheels, you may hear sounds from the brakes, or feel a corresponding sensation in the brake pedal. This is normal and it means your ABS is active.

ABS does not reduce the time or distance it takes to stop the vehicle.

Always maintain a safe distance from the vehicle in front of you.

ABS will not prevent a skid that results from sudden changes in direction, such as trying to take a corner too fast or making a sudden lane change. Always drive at a safe speed for the road and weather conditions.

ABS cannot prevent a loss of stability. Always steer moderately when braking hard. Severe or sharp steering wheel movement can still cause your vehicle to veer into oncoming traffic or off the road.

On loose or uneven road surfaces, operation of the anti-lock brake system may result in a longer stopping distance than for vehicles equipped with a conventional brake system.

The ABS ((ABS)) warning light will stay on for several seconds after the ignition switch or Engine Start/Stop button is in the ON position.

During that time, ABS will go through self-diagnosis and the light will go off if everything is normal. If the light stays on, you may have a problem with your ABS. Contact an authorized HYUNDAI dealer as soon as possible.



## WARNING

If the ABS ((ABS)) warning light is on and stays on, you may have a problem with the ABS. Your power brakes will work normally. To reduce the risk of serious injury or death, contact your authorized HYUNDAI dealer as soon as possible.

## NOTICE

When you drive on a road having poor traction, such as an icy road, and apply your brakes continuously, ABS will be active continuously and the ABS ((ABS)) warning light may illuminate. Pull your vehicle over to a safe place and turn the vehicle off.

Restart the vehicle. If the ABS warning light is off, then your ABS system is normal.

Otherwise, you may have a problem with your ABS system. Contact an authorized HYUNDAI dealer as soon as possible.



## Information

When you jump start your vehicle because of a drained battery, the ABS ((ABS)) warning light may turn on at the same time. This happens because of the low battery voltage. It does not mean your ABS is malfunctioning. Have the battery recharged before driving the vehicle.

## Electronic Stability Control (ESC)



Electronic Stability Control helps to stabilize the vehicle during cornering maneuvers.

ESC checks where you are steering and where the vehicle is actually going. ESC applies braking pressure to any one of the vehicle's brakes and intervenes in the engine management system to assist the driver with keeping the vehicle on the intended path. It is not a substitute for safe driving practices. Always adjust your speed and driving to the road conditions.

### **WARNING**

**Never drive too fast for the road conditions when cornering. ESC will not prevent accidents.**

**Excessive speed in turns, abrupt maneuvers, and hydroplaning on wet surfaces can result in severe accidents.**

### **ESC operation**

#### **ESC ON condition**

When the ignition switch or Engine Start/Stop button is in the ON position, ESC and the ESC OFF indicator lights illuminate for approximately three seconds. After both lights go off, ESC is enabled.

#### **When operating**



When ESC is in operation, the ESC indicator light blinks:

- When you apply your brakes under conditions which may lock the wheels, you may hear sounds from the brakes, or feel a corresponding sensation in the brake pedal. This is normal and it means your ESC is active.
- When ESC activates, the engine may not respond to the accelerator as it does under routine conditions.
- When moving out of the mud or driving on a slippery road, the engine RPM (revolutions per minute) may not increase even if you press the accelerator pedal deeply. This is to maintain the stability and traction of the vehicle and does not indicate a problem.

### ESC OFF condition



To cancel ESC operation:

- State 1

Press the ESC OFF button briefly. The ESC OFF indicator light and/or message 'Traction and Stability Control limited' will illuminate. In this state, the traction control function of ESC (engine management) is disabled, but the brake control function of ESC (braking management) still operates.

- State 2

Press and hold the ESC OFF button continuously for more than 3 seconds. The ESC OFF indicator light and/or message 'Traction and Stability Control disabled' illuminates and a warning chime sounds. In this state, both the traction control function of ESC (engine management) and the brake control function of ESC (braking management) are disabled.

If the ignition switch or Engine Start/ Stop button is placed to the LOCK/OFF position when ESC is off, ESC remains off. Upon restarting the vehicle, ESC will automatically turn on again.

### Indicator lights

- ESC indicator light (blinks)



- ESC OFF indicator light (comes on)



When the ignition switch is placed to the ON position, the ESC indicator light illuminates, then goes off if the ESC system is operating normally.

The ESC indicator light blinks whenever ESC is operating.

If the ESC indicator light stays on, your vehicle may have a malfunction with the ESC system. When this warning light illuminates, have the vehicle checked by an authorized HYUNDAI dealer as soon as possible.

The ESC OFF indicator light comes on when ESC is turned off.



### WARNING

**When ESC is blinking, this indicates ESC is active:**

**Drive slowly and NEVER attempt to accelerate. NEVER turn ESC off while the ESC indicator light is blinking or you may lose control of the vehicle resulting in an accident.**

### NOTICE

**Driving with wheels and tires with different sizes may cause the ESC system to malfunction. Before replacing tires, make sure all four tires and wheels are the same size. Never drive the vehicle with different sized wheels and tires installed.**

### ESC OFF usage

#### When Driving

The ESC OFF mode should only be used briefly to help free the vehicle if stuck in snow or mud, by temporarily stopping operation of ESC, to maintain wheel torque.

To turn ESC off while driving, press the ESC OFF button while driving on a flat road surface.

#### NOTICE

To prevent damage to the transmission:

- Do not allow wheel(s) of one axle to spin excessively while the ESC, ABS, and Parking Brake warning lights are displayed. The repairs would not be covered by the vehicle warranty. Reduce engine power and do not spin the wheel(s) excessively while these lights are displayed.
- When operating the vehicle on a dynamometer, make sure ESC is turned off (ESC OFF light illuminated).

#### Information

Turning ESC off does not affect ABS or standard brake system operation.

### Vehicle Stability Management (VSM)

Vehicle Stability Management is a function of the Electronic Stability Control (ESC) system. It helps the vehicle stay stable when accelerating or braking suddenly on wet, slippery and rough roads where traction over the four tires can suddenly become uneven.



#### WARNING

Take the following precautions when using Vehicle Stability Management:

- ALWAYS check the speed and the distance to the vehicle ahead. VSM is not a substitute for safe driving practices.
- Never drive too fast for the road conditions. VSM will not prevent accidents. Excessive speed in bad weather, on slippery and uneven roads can result in severe accidents.

## VSM operation

### When operating

When you apply your brakes under conditions which may activate ESC, you may hear sounds from the brakes, or feel a corresponding sensation in the brake pedal. This is normal and it means your VSM is active.

## Information

VSM does not operate when:

- Driving on a banked road such as gradient or incline.
- Driving in reverse.
- The ESC OFF indicator light is on.
- The MDPS (Motor Driven Power Steering) warning light () is on or blinks.



## VSM OFF condition

To cancel VSM operation, press the ESC OFF () indicator light will illuminate.

To turn on VSM, press the ESC OFF button again. The ESC OFF indicator light will go out.



## WARNING

If the ESC () indicator light or MDPS () warning light stays illuminated or blinks, your vehicle may have a malfunction with the VSM system. When the warning light illuminates have the vehicle checked by an authorized HYUNDAI dealer as soon as possible.

## NOTICE

Driving with wheels and tires with different sizes may cause the VSM system to malfunction. Before replacing tires, make sure all four tires and wheels are the same size. Never drive the vehicle with different sized tires and wheels installed.

### Hill-Start Assist Control (HAC)

Hill-Start Assist Control helps prevent the vehicle from rolling backwards when starting a vehicle from a stop on a hill. The system operates the brakes automatically for approximately 2 seconds (maximum of 5 seconds when the accelerator pedal is slightly depressed during HAC operation) and releases the brake after 2 seconds or when the accelerator pedal is depressed.



#### WARNING

**Always be ready to depress the accelerator pedal when starting off an incline. Hill-Start Assist Control activates only for approximately 2 seconds (maximum of 5 seconds when the accelerator pedal is slightly depressed during HAC operation).**



#### Information

- **Hill-Start Assist Control does not operate when the gear is shifted to P (Park) or N (Neutral).**
- **Hill-Start Assist Control activates even when the ESC (Electronic Stability Control) is off. However, it does not activate, when ESC does not operate normally.**

### Trailer Stability Assist (TSA)

Trailer stability assist is operated as a vehicle stability control system. The Trailer stability assist system stabilizes the vehicle and trailer when the trailer sways or oscillates. There are various reasons making vehicle sway and oscillate. In most case it happens at high speed however, if the trailer is affected by crosswinds, buffeting, and improper overloading, it may also be a risk of sway.

Factors of swaying such as:

- High speed
- Strong crosswinds
- Improper overloading
- Sudden controlling of steering wheel
- Uneven road

Trailer stability assist system continuously analyzes the vehicle and trailer instability. When the Trailer stability assist system detects some sway, the brakes are applied automatically to stabilize the vehicle on the front wheel. However, if it is not enough to stabilize, the brakes are applied on all wheels automatically and engine power is properly reduced. When the vehicle is stable from swaying, trailer stability assist system does not operate.

### **Brake Assistant System (BAS)**

The Brake Assistant System provides additional pressure when the brake pedal is momentarily and strongly depressed in a situation sudden braking is required while driving.

The Brake Assistant System reduces the time for ABS (Anti-Lock Brake System) control to enter and consequently reduces the braking distance, by providing additional pressure up to the point of ABS intervention.

#### **BAS operation**

- When the vehicle speed is more than 19 mph (30 km/h) and the ABS control is not entered.
- When the brake pedal is depressed strongly over a certain level.
- When the friction of the road surface is above a certain level.

#### **BAS operation off**

- The vehicle speed is below 6 mph (10 km/h).
- The brake pedal is depressed over a certain conditions.
- The friction of the road surface is below a certain level.



### **WARNING**

**The system may not operate depending on driver's driving habit, the degree to which the brake pedal is depressed and the road surface condition.**

### **Downhill Brake Control (DBC)**

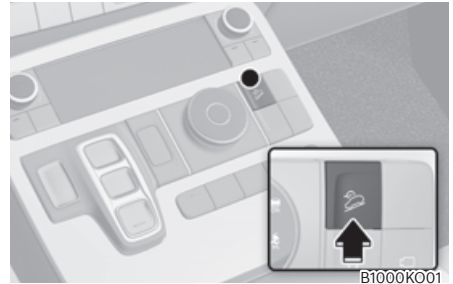

Downhill Brake Control assists the driver to descend down a steep hill without having to depress the brake pedal.





The system automatically applies the brakes to maintain vehicle speed below a certain speed and allows the driver to concentrate on steering the vehicle down hill.

The system is turned off whenever the engine is turned off.

Press the button to turn on the system and press the button again to turn it off.



**System operation**

Mode	Indicator	Description
Standby	 Green light on	Press the Downhill Brake Control button when vehicle speed is under 37 mph (60 km/h). Downhill Brake Control will turn on and enter the standby mode. The system does not turn on if vehicle speed is over 37 mph (60 km/h).
Activated	 Green light blink	In the standby mode, Downhill Brake Control will activate under the following conditions: <ul style="list-style-type: none"> <li>• The hill is steep enough.</li> <li>• The brake pedal or accelerator pedal is not depressed.</li> <li>• Vehicle speed is within 2–25 mph (4–40 km/h) range (within 2–5 mph (4–8 km/h) when reversing).</li> </ul> Within the activation speed range 2–25 mph (4–40km/h), the driver can control the vehicle speed by depressing the brake pedal or accelerator pedal.
Deactivated	 Green light off	Downhill Brake Control will turn off under the following conditions: <ul style="list-style-type: none"> <li>• The Downhill Brake Control button is pressed again.</li> <li>• Vehicle speed is over 37 mph (60 km/h).</li> </ul>
	 Green light on	Downhill Brake Control will be deactivated but maintain the standby mode under the following conditions: <ul style="list-style-type: none"> <li>• The hill is not steep enough.</li> <li>• Vehicle speed is between 18–37 mph (30–60 km/h).</li> </ul>
System malfunction	 Yellow light on	The yellow warning light illuminates when the system may have malfunctioned or may not work properly during activation. If this occurs, Downhill Brake Control is deactivated. Have the system be inspected by an authorized HYUNDAI dealer as soon as possible.

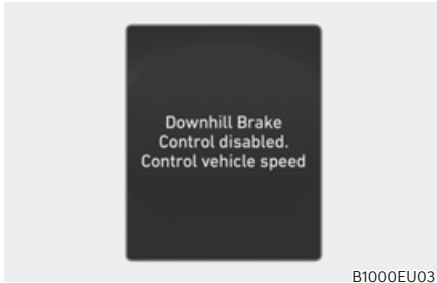

**Downhill Brake Control disabled. Control vehicle speed (manually)**

When Downhill Brake Control is not working properly this warning message will appear on the cluster LCD display and you will hear a warning sound. If this occurs, control vehicle speed by depressing the brake pedal.

 **WARNING**

**Always turn off Downhill Brake Control on normal roads. The system might activate inadvertently from the standby mode when driving through speed bumps or making sharp curves.**

 **Information**

- **Downhill Brake Control may not deactivate on steep inclines even though the brake pedal or accelerator pedal is depressed.**
- **Downhill Brake Control may not always maintain vehicle speed at a certain speed.**
- **Downhill Brake Control does not operate when:**
  - **The gear is in P (Park).**
  - **ESC is activated.**
- **Noise or vibration may occur from the brakes when Downhill Brake Control is activated.**
- **The rear stop light comes on when Downhill Brake Control is activated.**

## Good Braking Practices



### **WARNING**

**Whenever leaving the vehicle or parking, always come to a complete stop and continue to depress the brake pedal. Shift the gear to the P (Park) position, then apply the parking brake, and place the ignition switch or press the Engine Start/Stop button to the LOCK/OFF position.**

**Vehicles parked with the parking brake not applied or not fully engaged may roll inadvertently and may cause injury to the driver and others. ALWAYS apply the parking brake before exiting the vehicle.**

Wet brakes can be dangerous! The brakes may get wet if the vehicle is driven through standing water or if it is washed. Your vehicle will not stop as quickly if the brakes are wet. Wet brakes may cause the vehicle to pull to one side.

To dry the brakes, apply the brakes lightly until the braking action returns to normal. If the braking action does not return to normal, stop as soon as it is safe to do so and call an authorized HYUNDAI dealer for assistance.

DO NOT drive with your foot resting on the brake pedal. Even light, but constant pedal pressure can result in the brakes overheating, brake wear, and possibly even brake failure.

If a tire goes flat while you are driving, apply the brakes gently and keep the vehicle pointed straight ahead while you slow down. When you are moving slowly enough for it to be safe to do so, pull off the road and stop in a safe location.

Keep your foot firmly on the brake pedal when the vehicle is stopped to prevent the vehicle from rolling forward.

## ALL WHEEL DRIVE (AWD) (IF EQUIPPED)

All Wheel Drive (AWD) delivers engine power to front and rear wheels for maximum traction. AWD is useful when extra traction is required, such as when driving on, muddy, wet, or snow-covered roads.



### WARNING

To reduce the risk of **SERIOUS INJURY** or **DEATH**:

- **Avoid high speeds when cornering or turning.**
- **Do not make quick steering wheel movements, such as sharp lane changes or fast, sharp turns.**
- **The risk of a rollover is greatly increased if you lose control of your vehicle at highway speeds.**
- **Loss of control often occurs if two or more wheels drop off the roadway and the driver over steers to reenter the roadway.**
- **In the event your vehicle leaves the roadway, do not steer sharply. Instead, slow down before pulling back into the travel lanes.**

### NOTICE

- **Do not drive in water if the level is higher than the bottom of the vehicle.**
- **Check your brake condition once you are out of mud or water. Depress the brake pedal several times as you move slowly until you feel normal braking return.**

- **Shorten your scheduled maintenance interval if you drive in off-road conditions such as sand, mud or water (see "Maintenance Under Severe Usage Conditions" section in chapter 9).**
- **Always wash your vehicle thoroughly after off road use, especially the bottom of the vehicle.**
- **Be sure to equip all four tires with the correct size and type.**
- **Make sure that a full time AWD vehicle is towed by a flat bed tow truck.**

## All Wheel Drive (AWD) Operation

### *Auto AWD mode (Normal driving)*



If the AWD system determines there is a need for four wheel drive, the engine's driving power is distributed to all four wheels automatically.

### *Multi terrain mode (if equipped)*

In the multi terrain mode, four-wheel drive, engine, transmission, braking is controlled to achieve optimal driving performance depending on the mode selected (SNOW/MUD/SAND).

## AWD Operation

### All Wheel Drive (AWD) mode selection

Transfer mode	Selection mode	Description
AWD AUTO (Normal driving)	-	In the AWD AUTO mode, under normal operating conditions, the vehicle operates similar to conventional 2WD vehicles. If the system determines there is a need for four wheel drive, the engine's driving power is distributed to all four wheels automatically. Use this mode when driving on normal roads. If you select the "Driving force distribution" in the cluster, Driving force distribution (AWD) state is displayed.
SNOW		In this mode, the vehicle can start stably by properly distributing the driving force of the vehicle on slippery roads such as snowy roads. And you can drive safely by suppressing wheel slip.
AWD LOCK		<ul style="list-style-type: none"> <li>The main goal of AWD Lock mode is to allow a driver to maximize the vehicle's traction under extreme driving conditions such as unpaved off-road, sandy roads, and muddy roads.</li> <li>AWD Lock mode is in operation only when a vehicle travels at 25 mph (40 km/h) or less. When travelling at 25 mph (40 km/h) or faster, the mode will switch to AWD Auto. When travelling at 20 mph (30 km/h) or less, the mode will switch back to AWD Lock.</li> <li>Press the AWD Lock mode switch again to switch back to AWD Auto.</li> </ul>

When the AWD LOCK mode is deactivated, a shock may be felt as the drive power is delivered entirely to the front wheels. This shock is not a mechanical failure.

## For safe AWD operation

### Before driving

- Make sure all passengers are wearing seat belts.
- Sit upright and closer to the steering wheel than usual. Adjust the steering wheel to a position comfortable for you to drive.

### Driving on snow-covered or icy roads

- Start off slowly by applying the accelerator pedal gently.
- Use snow tires or tire chains.
- Keep sufficient distance between your vehicle and the vehicle in front of you.
- Apply engine braking during deceleration by using the paddle shifter (manual shift mode) and manually selecting a lower gear.
- Avoid speeding, rapid acceleration, sudden brake applications, and sharp turns to prevent skids.



## Information

**When using Snow Tires, mount them on all four wheels.**

**When using tire chains, install them on the rear tires. However, driving speed must be below 20 mph (30 km/h) and minimize the driving distance. High-speed or long-term driving with tire chains installed may malfunction or damage the AWD system.**

**For more details on Snow Tires and Tire Chains, refer to "Winter Driving" section later in this chapter.**

### Driving in sand or mud

- Maintain slow and constant speed.
- Use tire chains driving in mud if necessary.
- Keep sufficient distance between your vehicle and the vehicle in front of you.
- Reduce vehicle speed and always check the road condition.
- Avoid speeding, rapid acceleration, sudden brake applications, and sharp turns to prevent getting stuck.

## NOTICE

**When the vehicle is stuck in snow, sand or mud, place a nonslip material under the drive wheels to provide traction OR slowly spin the wheels in forward and reverse directions which causes a rocking motion that may free the vehicle.**

**However, avoid running the engine continuously at high RPM, doing so may damage the AWD system.**

### Driving up or down hills

- Driving uphill
  - Before starting off, check if it is possible to drive uphill.
  - Drive as straight as possible.
- Driving downhill
  - Do not change gear while driving downhill. Select gear before driving downhill.
  - Drive slowly using engine braking while driving downhill.
  - Drive straight as possible.



## WARNING

**Exercise extreme caution driving up or down steep hills. The vehicle may flip over depending on the grade, terrain, water and mud conditions.**



### WARNING

**Do not drive across the contour of steep hills. A slight change in the wheel angle can destabilize the vehicle, or a stable vehicle may lose stability if the vehicle stops its forward motion. Your vehicle may roll over and lead to a serious injury or death.**

#### Driving through water

- Try to avoid driving in deep standing water. It may stall your engine and clog your exhaust pipes.
- If you need to drive in water, stop your vehicle, set the vehicle in AWD LOCK mode and drive under 5 mph (8 km/h).
- Do not change gear while driving in water.



### CAUTION

**Always drive slowly in water. If you drive too fast, water may get into the engine compartment and wet the ignition system causing your vehicle to suddenly stop.**

#### Additional driving conditions

- Become familiar with the off-road conditions before driving.
- Always pay attention when driving off-road and avoid dangerous areas.
- Drive slowly when driving in heavy wind.
- Reduce vehicle speed when cornering. The center of gravity of AWD vehicles is higher than conventional 2WD vehicles, making them more likely to roll over when you rapidly turn corners.
- Always hold the steering wheel firmly when you are driving off-road.



### WARNING

**Do not grab the inside of the steering wheel when you are driving off-road. You may hurt your arm by a sudden steering maneuver or from steering wheel rebound due to an impact with objects on the ground. You could lose control of the steering wheel which may lead to serious injury or death.**

## Emergency Precautions

### Tires

When replacing tires, be sure to equip all four tires with the same size, type, tread patterns, brand and load-carrying capacity.



### WARNING

**Do not use tire and wheel with different size and type from the one originally installed on your vehicle. It can affect the safety and performance of your vehicle, which could lead to steering failure or rollover causing serious injury.**

In an emergency situation, a compact spare tire (if equipped) or Tire Mobility Kit (if equipped) may be used. But, do not use the compact spare tire continuously. Repair or replace the original tire as soon as possible to avoid failure of the differential or AWD system.

## WARNING



**Never start or run the engine while an AWD vehicle is raised on a jack. The vehicle can slip or roll off of a jack causing serious injury or death to you or those nearby.**

### **Towing**

AWD vehicles must be towed with a wheel lift and dollies or flatbed equipment with all the wheels off the ground. For more details, refer to "Towing" section in chapter 8.

### **Vehicle inspection**

- If the vehicle needs to be operated on a vehicle lift do not attempt to stop any of the four wheels from turning. This could damage the AWD system.
- Never engage the parking brake while running the engine on vehicle lift. This may damage the AWD system.

### **Dynamometer testing**

An AWD vehicle must be tested on a special four wheel chassis dynamometer.

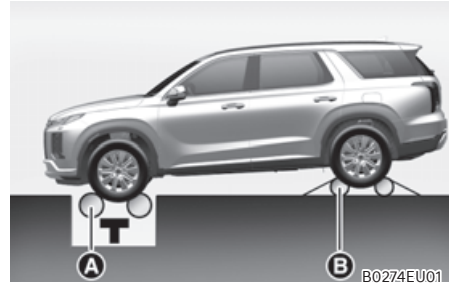

- Ⓐ: Roll tester (Speedometer),  
Ⓑ: Temporary free roller



An AWD vehicle should not be tested on a 2WD roll tester. If a 2WD roll tester must be used, perform the following procedure:

1. Check the tire pressures recommended for your vehicle.
2. Place the rear wheels on the roll tester for a speedometer test as shown in the illustration.
3. Release the parking brake.
4. Place the front wheels on the temporary free roller as shown in the illustration.

## WARNING

**Keep away from the front of the vehicle while the vehicle is in gear on the dynamometer. The vehicle can jump forward and cause serious injury or death.**

### **AWD malfunction**

If the AWD  warning light stays on the instrument cluster, your vehicle may have a malfunction with the AWD system. When the AWD warning light  illuminates, have the vehicle be checked by an authorized HYUNDAI dealer as soon as possible.



## IDLE STOP AND GO (ISG) (IF EQUIPPED)

Idle Stop and Go helps reduce fuel consumption by automatically shutting down the engine, when the vehicle is at a standstill (for example, red stop light, stop sign, and traffic jam) subject to certain prerequisite conditions being satisfied as listed below.

The engine is automatically started upon satisfying the starting conditions.

ISG system is always active, when the engine is running.

### Information

**When the engine is automatically started by ISG system, warning lights (for example, ABS, ESC, ESC OFF, MDPS, and parking brake warning light) may illuminate for a few seconds due to low battery voltage.**

**However, it does not indicate a malfunction with ISG system.**

### ISG System Operation

#### **Prerequisite for activation**

ISG system operates in the following situations.

- The driver's seatbelt is fastened
- The driver's door and hood are closed
- The brake vacuum pressure is adequate
- The battery sensor is activated and the battery is sufficiently charged
- Outside temperature is not too low or too high
- The vehicle is driven over a constant speed and stops
- The climate control system satisfies the conditions

- The vehicle is sufficiently warmed up
- ISG related parts are working properly
- The incline is gradual
- The steering wheel is turned less than 180 degrees and then the vehicle stops

### Information

**ISG system is not activated, when the prerequisites to activate the ISG system are unsatisfied.**

### **Auto stop**

When ISG is on the engine will be stopped automatically when both of the following occurs:

1. Vehicle speed decreases to 0 mph (0 km/h) full stop condition.
2. Brake pedal is depressed and gear is in D (Drive) or N (Neutral).

The Auto Stop () indicator illuminates in green on the instrument cluster, when the engine stops.

### Information

**Idle stop cannot reoccur again until the vehicle speed goes above 3 mph (5 km/h) and then returns again to the automatic stop conditions as previously mentioned.**

In the Auto Stop mode, if the engine hood is opened, ISG system will be deactivated.

When the system is deactivated, the ISG off button indicator will illuminate and a message 'Auto Stop error. Shift to P or N to start engine manually' appears on the cluster LCD display with a warning sound.

If this occurs, depress the brake pedal and restart the engine manually.

### **Auto start**

When the engine stops automatically by ISG, the engine will restart if one of the following is done.

- Release the brake pedal.
- When Auto Hold is activated, take your foot off the brake pedal and then depress the accelerator pedal.
- While depressing the brake pedal, shift the gear from N (Neutral) or D (Drive) to R (Reverse) or P (Park).
- While depressing the brake pedal, shift the gear from N (Neutral) to D (Drive).

### **LCD display messages**

The messages are displayed on the instrument cluster to help use ISG system.

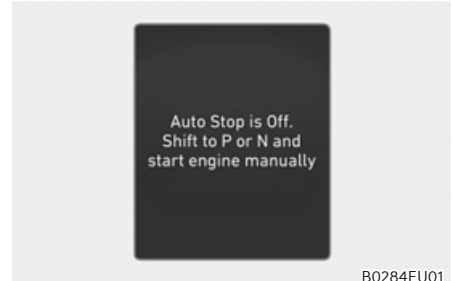

#### **Auto Stop is Off. Shift to P or N and start engine manually**

When the system is deactivated, the ISG off button indicator will illuminate and a message will appear on the cluster LCD display with a warning sound in the following situations.

- When the engine hood is opened.
- When ISG system is not working normally.

If this occurs, depress the brake pedal and restart the engine manually. For your safety, restart the vehicle in the P (Park) position.

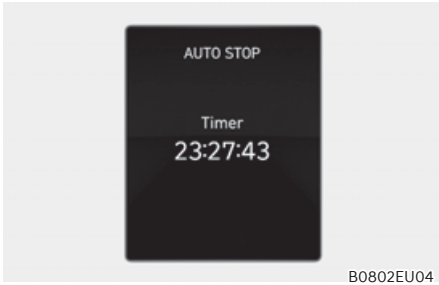

B0802EU04

### AUTO STOP elapsed time

AUTO STOP display shows the elapsed time of engine stop by the Idle Stop and Go system.

You may check AUTO STOP elapsed time in the Utility view on the instrument cluster.

To reset the information, press and hold the OK button when viewing the AUTO STOP. The AUTO STOP elapsed time will reset simultaneously. Refer to “View Modes” section in chapter 4.

### ISG System Off



B0285K001

Press the ISG OFF button to turn off ISG system. The ISG OFF button indicator will illuminate. To use the system, press the ISG OFF button again.

## Forced to Restart Engine

The engine is automatically restarted in the following situations.

- The brake vacuum pressure is low
- The engine has stopped for about 5 minutes
- The air conditioning is ON with the fan speed set to a certain high level
- The front defroster is ON
- The battery is weak
- The cooling and heating performance of the climate control system is unsatisfactory
- The vehicle is shifted to P (Park) or R (Reverse)
- The door is opened or the seatbelt is unfastened
- The EPB switch is pressed when Auto Hold is activated

The Auto Stop (A) indicator blinks in green for 5 seconds on the instrument cluster when the engine is restarted.



### WARNING

**When the engine is in Idle Stop mode, the engine may restart without the driver taking any action. Before leaving the vehicle or working on the engine compartment, turn off the engine by placing the ignition switch to the LOCK/OFF position.**

## ISG Malfunction

ISG system may not operate when there is a malfunction with the ISG sensors or ISG system.

The following will occur, when there is a malfunction with the ISG system:

- The Auto Stop (A) indicator will illuminate in yellow on the instrument cluster.
- The light on the ISG OFF button will illuminate.

Contact an authorized HYUNDAI dealer.

## Calibrating the Battery Sensor

If the AGM battery is reconnected or replaced, ISG system will not operate immediately. If you want to use the system, the battery sensor needs to be calibrated following the below procedure.

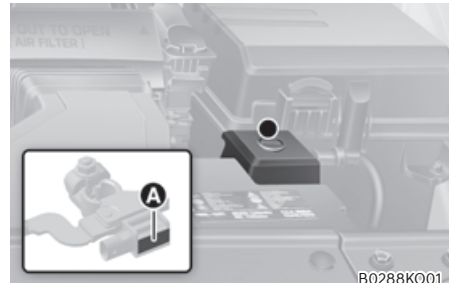

(A): Battery sensor

1. Turn off the engine.
2. Disconnect all electronic devices that were additionally installed after the vehicle was delivered, such as navigation, dashcam, etc.
3. After 4 hours with the engine off, turn the engine on and off 3 to 4 times.

**i** Information

The ISG system may not operate in the following situations.

- There is a malfunction with the ISG system.
- The battery is weak.
- The brake vacuum pressure is low.

If this occurs, have the ISG system checked by an authorized HYUNDAI dealer.

**NOTICE**

Use only a genuine HYUNDAI ISG battery for replacement. If not, the ISG system may not properly operate.

Do not recharge the ISG battery with a general battery charger. It may damage or explode the ISG battery.

Do not remove the battery cap. The battery electrolyte, which is harmful to the human body, may leak out.

## DRIVE MODE INTEGRATED CONTROL SYSTEM

### Selecting Drive Mode

Drive mode may be selected according to the driver's preference or road condition.

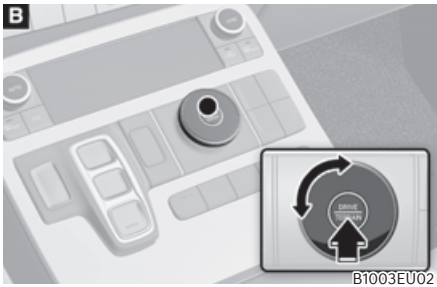

Ⓐ: 2WD, Ⓑ: AWD

### Changing Drive Mode

- The mode changes whenever the DRIVE MODE selection knob is rotated.
- Press the DRIVE/TERRAIN button to change from normal driving mode to multi terrain mode. After the button is pressed, rotate the knob within 4 seconds to select SNOW, MUD or SAND. (AWD)

### ECO mode (if equipped)



ECO mode helps improve fuel efficiency for eco-friendly driving.

Fuel efficiency varies according to the driver's driving habit and road condition.

- When ECO mode is selected, the ECO indicator will illuminate on the instrument cluster.
- When ECO mode is activated:
  - The acceleration response may be slightly reduced if the accelerator pedal is depressed moderately.
  - The air conditioner performance may be limited.
  - The shift pattern of the automatic transmission may change.
  - Engine noise may be louder at some automatic transmission shifts as down-shift requires pressing down more on the accelerator.

The above situations are normal conditions when ECO mode is activated to help improve fuel efficiency.

### **SPORT mode**

**SPORT** SPORT mode provides sporty but firm riding.

In SPORT mode, the fuel efficiency may decrease.

- When SPORT mode is selected, the SPORT indicator will illuminate on the instrument cluster.
- Whenever the engine is restarted, the drive mode will revert back to COMFORT mode. If SPORT mode is desired, re-select SPORT mode.
- When SPORT mode is activated:
  - The engine RPM will tend to remain raised over a certain length of time even after releasing the accelerator
  - Upshifts are delayed when accelerating

### **NOTICE**

**In the SPORT mode, the fuel efficiency may decrease.**

### **CUSTOM Mode Features**

#### **SMART mode**

SMART mode selects the proper driving mode among SMART ECO, SMART COMFORT and SMART SPORT by judging the driver's driving habits (for example, mild or dynamic) from the brake pedal depression or the steering wheel operation.

#### **Various driving situations, which you may encounter in SMART mode**

- The driving mode automatically changes to ECO mode after a certain period of time, when you gently depress the accelerator pedal (Your driving is categorized to be mild.).
- The driving mode automatically changes from SMART ECO mode to SMART COMFORT mode after a certain period of time, when you sharply or repetitively depress the accelerator pedal.
- The driving mode automatically changes to SMART COMFORT mode with the same driving patterns, when the vehicle starts to drive on an upward slope of a certain angle. The driving mode automatically returns to SMART ECO mode, when the vehicle enters a leveled road.
- The driving mode automatically changes to SMART SPORT mode only in harsh driving situations. In most of the normal driving situations, the driving mode sets to be either in SMART ECO mode or in SMART COMFORT mode.

- The driving mode automatically changes to SMART SPORT, when you abruptly accelerate the vehicle or repetitively operate the steering wheel (Your driving is categorized to be sporty.). In this mode, your vehicle drives in a lower gear for abrupt accelerating or decelerating and increases the engine brake performance.

For general description of SMART ECO, SMART COMFORT, and SMART SPORT modes, refer to “ECO, COMFORT, SPORT mode features”.

### **Limitation of SMART mode**

SMART may be limited in following situations. ECO, COMFORT, SPORT mode features

- The driver is using the paddle shifter to manually shift gear. (The system prioritizes the driver’s manual shifting)
- Smart Cruise Control is activated.
- The transmission oil temperature is either extremely low or extremely high.

### **i Information**

- **When you mildly drive the vehicle in SMART mode, the driving mode changes to ECO mode to improve fuel efficiency. However, the actual fuel efficiency may differ depending on your driving situations such as slope angle, and vehicle speed.**
- **When you dynamically drive the vehicle in SMART mode by abruptly decelerating or sharply curving, the driving mode changes to SPORT mode. However, it may adversely affect fuel economy.**

### **Multi Terrain Mode (AWD, if equipped)**

Multi terrain mode may be selected according to the driver's preference or road condition.



B1001K008

Press the DRIVE/TERRAIN button to change from Drive mode to Multi terrain mode. After the button is pressed, rotate the knob within 4 seconds to select SNOW, MUD or SAND. When the DRIVE/TERRAIN button is pressed again, the previous Drive mode will be reselected.



B1003EU01

For more details on Terrain mode, refer to “All Wheel Drive” section in this chapter.



### TOW Mode (if equipped)

When towing a trailer, switching to TOW mode enables smooth driving by changing the shifting pattern to suit heavy loads.

#### Operating button



Press the Tow mode button to turn on or off the function.

### Setting features

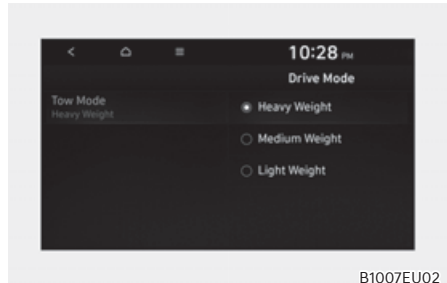

When the gear is in P(Park), select 'Setup → Vehicle → Drive Mode → Tow Mode' from the infotainment system to set the weight of trailer to be towed.

#### **i** Information

**It is impossible to change Drive/Terrain mode when operating in Tow mode.**

## SPECIAL DRIVING CONDITIONS

### Hazardous Driving Conditions

When hazardous driving elements are encountered such as water, snow, ice, mud and sand, take the following precautions:

- Drive cautiously and maintain a longer braking distance.
- Avoid abrupt braking or steering.
- When your vehicle is stuck in snow, mud, or sand, use second gear. Accelerate slowly to avoid unnecessary wheel spin.
- Put sand, rock salt, tire chains or other non-slip materials under the wheels to provide additional traction while the vehicle becomes stuck in ice, snow, or mud.



#### WARNING

Using the paddle shifters to downshift to a lower gear while driving on slippery surfaces can cause an accident. The sudden change in tire speed could cause the tires to skid. Be careful when downshifting on slippery surfaces.

### Rocking the Vehicle

If it is necessary to rock the vehicle to free it from snow, sand, or mud, first turn the steering wheel right and left to clear the area around your front wheels. Then, shift back and forth between R (Reverse) and a forward gear.

Try to avoid spinning the wheels, and do not race the engine.

To prevent transmission wear, wait until the wheels stop spinning before shifting gears. Release the accelerator pedal while shifting, and press lightly on the accelerator pedal while the transmission is in gear. Slowly spinning the wheels in forward and reverse directions causes a rocking motion that may free the vehicle.



#### WARNING

If the vehicle is stuck and excessive wheel spin occurs, the temperature in the tires can increase very quickly. If the tires become damaged, a tire blow out or tire explosion can occur. This condition is dangerous - you and others may be injured. Do not attempt this procedure if people or objects are anywhere near the vehicle.

If you attempt to free the vehicle, the vehicle can overheat quickly, possibly causing an engine compartment fire or other damage. Try to avoid spinning the wheels as much as possible to prevent overheating of either the tires or the engine. **DO NOT** allow the vehicle to spin the wheels above 35 mph (56 km/h).

## **i** Information

The ESC system must be turned OFF before rocking the vehicle.

### **NOTICE**

If you are still stuck after rocking the vehicle a few times, have the vehicle pulled out by a tow vehicle to avoid engine overheating, possible damage to the transmission, and tire damage. See “Towing” section in chapter 8.

## Smooth Cornering

Avoid braking or gear changing in corners, especially when roads are wet. Ideally, corners should always be taken under gentle acceleration.

## Driving at Night

Night driving presents more hazards than driving in the daylight. Here are some important tips to remember:

- Slow down and keep more distance between you and other vehicles, as it may be more difficult to see at night, especially in areas where there may not be any street lights.
- Adjust your mirrors to reduce the glare from other drivers’ headlights.
- Keep your headlights clean and properly aimed. Dirty or improperly aimed headlights will make it much more difficult to see at night.
- Avoid staring directly at the headlights of oncoming vehicles. You could be temporarily blinded, and it will take several seconds for your eyes to readjust to the darkness.

## Driving in the Rain

Rain and wet roads can make driving dangerous. Here are a few things to consider when driving in the rain or on slick pavement:

- Slow down and allow extra following distance. A heavy rainfall makes it harder to see and increases the distance needed to stop your vehicle.
- Turn OFF your Cruise Control. (if equipped)
- Replace your windshield wiper blades when they show signs of streaking or missing areas on the windshield.
- Be sure your tires have enough tread. If your tires do not have enough tread, making a quick stop on wet pavement can cause a skid and possibly lead to an accident. See “Tire Tread” section in chapter 9.
- Turn on your headlights to make it easier for others to see you.
- Driving too fast through large puddles can affect your brakes. If you must go through puddles, try to drive through them slowly.
- If you believe your brakes may be wet, apply them lightly while driving until normal braking operation returns.

## Hydroplaning

If the road is wet enough and you are going fast enough, your vehicle may have little or no contact with the road surface and actually ride on the water. The best advice is SLOW DOWN when the road is wet.

The risk of hydroplaning increases as the depth of tire tread decreases, refer to “Tire Tread” section in chapter 9.

## Driving in Flooded Areas

Avoid driving through flooded areas unless you are sure the water is no higher than the bottom of the wheel hub. Drive through any water slowly. Allow adequate stopping distance because brake performance may be reduced. After driving through water, dry the brakes by gently applying them several times while the vehicle is moving slowly.

## Highway Driving

### Tires

Adjust the tire inflation, as specified. Under-inflation may overheat or damage the tires.

Do not install worn-out or damaged tires, which may reduce traction or fail the braking operation.

### Information

**Never over-inflate your tires above the maximum inflation pressure, as specified on your tires.**

### **Fuel, engine coolant and engine oil**

Driving at higher speeds on the highway consumes more fuel and is less efficient than driving at a slower, more moderate speed. Maintain a moderate speed in order to conserve fuel when driving on the highway.

Be sure to check both the engine coolant level and the engine oil before driving.

### **Drive belt**

A loose or damaged drive belt may overheat the engine.

### Reducing the Risk of a Rollover

Your multi-purpose passenger vehicle is defined as a Sports Utility Vehicle (SUV). SUV's have higher ground clearance and a narrower track to make them capable of performing in a wide variety of off-road applications. The specific design characteristics give them a higher center of gravity than ordinary vehicles making them more likely to roll over if you make abrupt turns. Utility vehicles have a significantly higher rollover rate than other types of vehicles. Due to this risk, driver and passengers are strongly recommended to buckle their seat belts. In a rollover crash, an unbelted person is significantly more likely to die than a person wearing a seat belt.

There are steps that a driver can make to reduce the risk of a rollover. If at all possible, avoid sharp turns or abrupt maneuvers, do not load your vehicle with heavy cargo on the roof, and never modify your vehicle in any way.



#### WARNING

**Utility vehicles have a significantly higher rollover rate than other types of vehicles. To prevent rollovers or loss of control:**

- **Take corners at slower speeds than you would with a passenger vehicle.**
- **Avoid sharp turns and abrupt maneuvers.**
- **Do not modify your vehicle in any way that you would raise the center of gravity.**
- **Keep tires properly inflated.**
- **Do not carry heavy cargo on the roof.**



#### WARNING

**In a rollover crash, an unbelted person is significantly more likely to die than a person wearing a seat belt. Make sure all passengers are wearing their seat belts.**

## WINTER DRIVING

The severe weather conditions of winter quickly wear out tires and cause other problems. To minimize winter driving problems, you should take the following suggestions:

### Snow or Icy Conditions

You need to keep sufficient distance between your vehicle and the vehicle in front of you.

Apply the brakes gently. Speeding, rapid acceleration, sudden brake applications, and sharp turns are potentially very hazardous practices. During deceleration, use engine braking to the fullest extent. Sudden brake applications on snowy or icy roads may cause the vehicle to skid.

To drive your vehicle in deep snow, it may be necessary to use snow tires or to install tire chains on your tires.

Always carry emergency equipment. Some of the items you may want to carry include tire chains, tow straps or chains, a flashlight, emergency flares, sand, a shovel, jumper cables, a window scraper, gloves, ground cloth, coveralls, a blanket, etc.

### Snow tires



#### WARNING

**Snow tires should be equivalent in size and type to the vehicle's standard tires. Otherwise, the safety and handling of your vehicle may be adversely affected.**

If you mount snow tires on your vehicle, make sure to use the same Inflation pressure as the original tires. Mount snow tires on all four wheels to balance your vehicle's handling in all weather conditions. The traction provided by snow tires on dry roads may not be as high as your vehicle's original equipment tires. Check with the tire dealer for maximum speed recommendations.

### **Summer tires (if equipped)**

- Summer tires are used to maximize the driving performance on dry roads.
- If the temperature is below 44.6°F or you are driving on snowy or icy roads, the summer tires lose their brake performance and traction as the tire grip weakens significantly.
- If the temperature is below 44.6°F or you are driving on snowy or icy roads, mount snow tires or all-season tires of the same size with your vehicle's standard tire for safe driving. Both snow and all-season tires have M+S markings.
- When using the M+S tires, use tires with the same tread produced by the same manufacturer for safe driving.
- When driving with the M+S tires with the lower maximum allowable speed than that of the vehicle's standard summer tire, be careful not to exceed the speed allowed for the M+S tires.

### **Tire chains**



B0308EU01

Since the sidewalls of radial tires are thinner than other types of tires, they may be damaged by mounting some types of tire chains on them. Therefore, the use of snow tires is recommended instead of tire chains. If tire chains must be used, use genuine HYUNDAI Parts and install the tire chain after reviewing the instructions provided with the tire chains. Damage to your vehicle caused by improper tire chain use is not covered by your vehicle manufacturer's warranty.



## WARNING

The use of tire chains may adversely affect vehicle handling:

- Drive less than 20 mph (30 km/h) or the chain manufacturer's recommended speed limit, whichever is lower.
- Drive carefully and avoid bumps, holes, sharp turns, and other road hazards, which may cause the vehicle to bounce.
- Avoid sharp turns or locked wheel braking.



## Information

- Install tire chains only in pairs and on the front tires. It should be noted that installing tire chains on the tires will provide a greater driving force, but will not prevent side skids.
- Do not install studded tires without first checking local and municipal regulations for possible restrictions against their use.

## Chain Installation

When installing tire chains, follow the manufacturer's instructions and mount them as tightly possible. Drive slowly (less than 20 mph (30 km/h)) with chains installed. If you hear the chains contacting the body or chassis, stop and tighten them. If they still make contact, slow down until the noise stops. Remove the tire chains as soon as you begin driving on cleared roads.

When mounting snow chains, park the vehicle on level ground away from traffic. Turn on the vehicle Hazard Warning Flasher and place a triangular emergency warning device behind the vehicle (if available). Always place the vehicle in P (Park), apply the parking brake and turn off the engine before installing snow chains.

## NOTICE

When using tire chains:

- Wrong size chains or improperly installed chains can damage your vehicle's brake lines, suspension, body and wheels.
- Use SAE "S" class or wire chains.
- If you hear noise caused by chains contacting the body, retighten the chain to prevent contact with the vehicle body.
- To prevent body damage, retighten the chains after driving 0.3–0.6 miles (0.5–1.0 km).
- Do not use tire chains on vehicles equipped with aluminum wheels. If unavoidable, use a wire type chain.
- Use wire chains less than 0.59 in. (15 mm) thick to prevent damage to the chain's connection.



### Winter Precautions

#### Use high quality ethylene glycol coolant

Your vehicle is delivered with high quality ethylene glycol coolant in the cooling system. It is the only type of coolant that should be used because it helps prevent corrosion in the cooling system, lubricates the water pump and prevents freezing. Be sure to replace or replenish your coolant in accordance with the maintenance schedule in chapter 9. Before winter, have your coolant tested to assure that its freezing point is sufficient for the temperatures anticipated during the winter.

#### Check battery and cables

Winter temperatures affect battery performance. Inspect the battery and cables, as specified in chapter 9. The battery charging level can be checked by an authorized HYUNDAI dealer or in a service station.

#### Change to “winter weight” oil if necessary

In some regions during winter, it is recommended to use the “winter weight” oil with lower viscosity. In addition, replace the engine oil and filter if it is close to the next maintenance interval. Fresh engine oil ensures optimum engine operation during the winter months. For further information, refer to chapter 2. When you are not sure about a type of winter weight oil, consult an authorized HYUNDAI dealer.

#### Check spark plugs and ignition system

**Inspect the spark plugs, as specified in chapter 9.** If necessary, replace them. Also check all ignition wirings and components for any cracks, wear-out, and damage.

#### To prevent locks from freezing

To prevent the locks from being frozen, spray approved de-icing fluid or glycerin into key holes. When a lock opening is already covered with ice, spray approved de-icing fluid over the ice to remove it. When an internal part of a lock freezes, try to thaw it with a heated key. Carefully use the heated key to avoid an injury.

#### Use approved window washer anti-freeze solution in system

To prevent the window washer from being frozen, add authorized window washer anti-freeze solution, as specified on the window washer container. Window washer anti-freeze solution is available from an authorized HYUNDAI dealer, and most vehicle accessory outlets. Do not use engine coolant or other types of anti-freeze solution, to prevent any damage to the vehicle paint.

**Do not let your parking brake freeze**

Under some conditions your parking brake can freeze in the engaged position. This is most likely to happen when there is an accumulation of snow or ice around or near the rear brakes or if the brakes are wet. When there is the risk that your parking brake may freeze, temporarily apply it with the gear in P (Park). Also, block the rear wheels in advance, so the vehicle may not roll. Then, release the parking brake.

**Do not let ice and snow accumulate underneath**

Under some conditions, snow and ice can build up under the fenders and interfere with the steering. When driving in such conditions during the severe winter, you should check underneath the vehicle on a regular basis, to ensure that the front wheels and the steering components is unblocked.

**Carry emergency equipment**

In accordance with weather conditions, you should carry appropriate emergency equipment, while driving. Some of the items you may want to carry include tire chains, tow straps or chains, flashlight, emergency flares, sand, shovel, jumper cables, window scraper, gloves, ground cloth, coveralls, blanket, etc.

**Do not place objects or materials in the engine compartment**

Putting objects or materials in the engine compartment may cause an engine failure or combustion, because they may block the engine cooling. Such damage will not be covered by the manufacturer's warranty.

**Drive your vehicle when water vapor condenses and accumulates inside the exhaust pipes**

When the vehicle is stopped for a long time in winter while the engine is running, water vapor may condense and accumulate inside the exhaust pipes. Water in the exhaust pipes may cause noise, etc., but it is drained driving at medium to high speed.

## TRAILER TOWING

If you are considering towing with your vehicle, be sure to take extra precautions while driving. Only experienced drivers should consider towing. Plan your trip accordingly as vehicle speed limits for vehicles towing trailers may be different. Always follow posted speed limits for vehicles towing with trailers.

Remember that trailering is different than just driving your vehicle by itself. Trailering means changes in handling, durability, and fuel economy. Successful, safe trailering requires correct equipment, and it has to be used properly. Damage to your vehicle caused by improper trailer towing is not covered by your vehicle manufacturer's warranty.

This section contains time-tested, important trailering tips and safety rules. Many of these are important for your safety and that of your passengers. Please read this section carefully before you pull a trailer.



### WARNING

Take the following precautions:

- **If you don't use the correct equipment and/or drive improperly, you can lose control of the vehicle when you are pulling a trailer. For example, if the trailer is too heavy, the braking performance may be reduced. You and your passengers could be seriously or fatally injured. Pull a trailer only if you have followed all the steps in this section.**
- **Before towing, make sure the total trailer weight, GCW (Gross Combination Weight), GVW (Gross Vehicle Weight), GAW (Gross Axle Weight) and trailer tongue load are all within the limits.**
- **When you tow a trailer, make sure to turn off the Idle Stop and Go system.**

### If You Decide to Pull a Trailer?

Here are some important points if you decide to pull a trailer:

- Consider using a sway control. You can ask a trailer hitch dealer about sway control.
- Do not do any towing with your vehicle during its first 1,200 miles (2,000 km) in order to allow the engine to properly break in. Failure to heed this caution may result in serious engine or transmission damage.
- When towing a trailer, consult an authorized HYUNDAI dealer for further information on additional requirements such as a towing kit, etc.
- Always drive your vehicle at posted towing speed limit.
- Carefully observe the weight and load limits provided in the following pages.
- When towing a trailer, be sure to disable Reverse Parking Collision-Avoidance Assist. If towing and going in reverse the system will activate as it detects the trailer. Also, before towing a trailer disable all Driving Assistance systems as precaution such as Forward Collision-Avoidance Assist, Lane Keeping Assist, Smart Cruise Control and others.

## Trailer weight

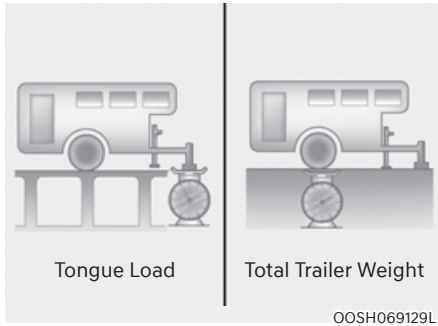

What is the maximum safe weight of a trailer? It should never weigh more than the maximum trailer weight with trailer brakes. But even that can be too heavy. It depends on how you plan to use your trailer. For example, speed, altitude, road grades, outside temperature and how often your vehicle is used to pull a trailer are all important. The ideal trailer weight can also depend on any special equipment that you have on your vehicle.

## Tongue load

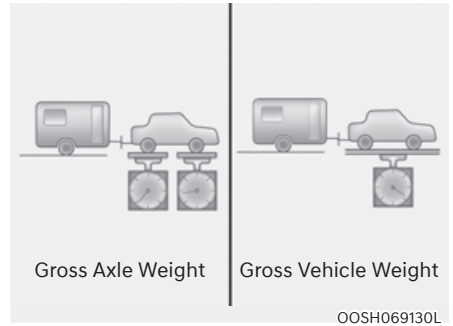

The tongue load is an important weight to measure because it affects the total Gross Vehicle Weight (GVW) of your vehicle. The trailer tongue should weigh a minimum of 10% of the total loaded trailer weight, within the limits of the maximum (15%) trailer tongue load permissible.

After you've loaded your trailer, weigh the trailer and then the tongue, separately, to see if the weights are proper. If they aren't, you may be able to correct them simply by moving some items around in the trailer.

## WARNING

Take the following precautions:

- **Never load a trailer with more weight in the rear than in the front. The front should be loaded with approximately 60% of the total trailer load; the rear should be loaded with approximately 40% of the total trailer load.**
- **Never exceed the maximum weight limits of the trailer or trailer towing equipment. Improper loading can result in damage to your vehicle and/or personal injury. Check weights and loading at a commercial scale or highway patrol office equipped with scales.**

**Reference weight and distance when towing a trailer**

Item		With trailer package
Maximum trailer weight  lbs. (kg)	With brake system	5000 (2268)
	Without brake system	1653 (750)
Maximum tongue weight *1  lbs. (kg)		500 (227)

\*1: Tongue weight should be between allowable 10-15%

**Trailer Towing Equipment Hitches**

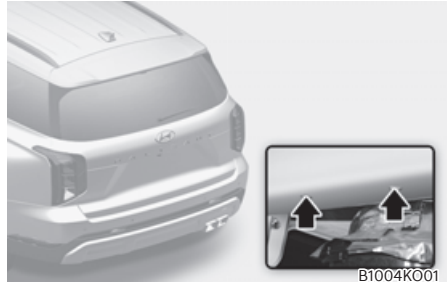

It's important to have the correct hitch equipment. Crosswinds, large trucks going by, and rough roads are a few reasons why you'll need the right hitch. Here are some rules to follow:

- Do you have to make any holes in the body of your vehicle when you install a trailer hitch? If you do, then be sure to seal the holes later when you remove the hitch. If you don't seal them, carbon monoxide (CO) from your exhaust can get into your vehicle, as well as dirt and water.
- The bumpers on your vehicle are not intended for hitches. Do not attach rental hitches or other bumper-type hitches to them. Use only a frame-mounted hitch that does not attach to the bumper.
- A HYUNDAI trailer hitch accessory is available at an authorized HYUNDAI dealer.

### **Safety chains**

You should always attach chains between your vehicle and your trailer.

Instructions about safety chains may be provided by the hitch manufacturer or trailer manufacturer. Follow the manufacturer's recommendation for attaching safety chains. Always leave just enough slack so you can turn with your trailer. And, never allow safety chains to drag on the ground.

### **Trailer brakes**

If your trailer is equipped with a braking system, make sure it conforms to your country's regulations and that it is properly installed and operating correctly.

If your trailer weighs more than the maximum trailer weight without trailer brakes loaded, then it needs its own brakes and they must be adequate. Be sure to read and follow the instructions for the trailer brakes so you'll be able to install, adjust and maintain them properly. Be sure not to modify your vehicle's brake system.



### **WARNING**

**Do not use a trailer with its own brakes unless you are absolutely certain that you have properly set up the brake system. This is not a task for amateurs. Use an experienced, competent trailer shop for this work.**

### **Driving with a Trailer**

Towing a trailer requires a certain amount of experience. Before setting out for the open road, you must get to know your trailer. Acquaint yourself with the feel of handling and braking with the added weight of the trailer. And always keep in mind that the vehicle you are driving is now longer and not nearly as responsive as your vehicle is by itself.

Before you start, check the trailer hitch and platform, safety chains, electrical connector(s), lights, tires and brakes.

During your trip, occasionally check to be sure that the load is secure, and that the lights and trailer brakes are still working.

### **Distance**

Stay at least twice as far behind the vehicle ahead as you would when driving your vehicle without a trailer. This can help you avoid situations that require heavy braking and sudden turns.

### **Passing**

You will need more passing distance up ahead when you're towing a trailer. And, because of the increased vehicle length, you'll need to go much farther beyond the passed vehicle before you can return to your lane.

### **Backing up**

Hold the bottom of the steering wheel with one hand. Then, to move the trailer to the left, move your hand to the left. To move the trailer to the right, move your hand to the right. Always back up slowly and, if possible, have someone guide you.

### **Making turns**

When you're turning with a trailer, make wider turns than normal. Do this so your trailer won't strike soft shoulders, curbs, road signs, trees, or other objects. Avoid jerky or sudden maneuvers. Signal well in advance.

### **Turn signals**

When you tow a trailer, your vehicle has to have a different turn signal flasher and extra wiring. The green arrows on your instrument panel will flash whenever you signal a turn or lane change. Properly connected, the trailer lights will also flash to alert other drivers you're about to turn, change lanes, or stop.

When towing a trailer, the green arrows on your instrument panel will flash for turns even if the bulbs on the trailer are burned out. Thus, you may think drivers behind you are seeing your signals when, in fact, they are not. It's important to check frequently to be sure the trailer bulbs are still working. You must also check the lights every time you disconnect and then reconnect the wires.



### **WARNING**

**Do not connect a trailer lighting system directly to your vehicle's lighting system. Use an approved trailer wiring harness. Failure to do so could result in damage to the vehicle electrical system and/or personal injury. Consult an authorized HYUNDAI dealer for assistance.**

### **Driving on hills**

Reduce speed and shift to a lower gear before you start down a long or steep downgrade. If you don't shift to a lower gear, you may have to use your brakes excessively and they would overheat and may not operate efficiently.

On a long uphill grade, shift to a lower gear and reduce your speed to around 45 mph (70 km/h) to reduce the possibility of engine and transmission overheating.

If your trailer weighs more than the maximum trailer weight without trailer brakes and you have an automatic transmission, you should drive in D (Drive) when towing a trailer.

Operating your vehicle in D (Drive) when towing a trailer will minimize heat build-up and extend the life of your transmission.

### **NOTICE**

**To prevent engine and/or transmission overheating:**

- **When towing a trailer on steep grades (in excess of 6%) pay close attention to the engine coolant temperature gauge to ensure the engine does not overheat. If the needle of the coolant temperature gauge moves towards "H" (HOT), pull over and stop as soon as it is safe to do so, and allow the engine to idle until it cools down. You may proceed once the engine has cooled sufficiently.**
- **When towing a trailer, your vehicle speed may be much slower than the general flow of traffic, especially when climbing an uphill grade. Use the right hand lane when towing a trailer on an uphill grade. Choose your vehicle speed according to the maximum posted speed limit for vehicles with trailers, the steepness of the grade, and your trailer weight.**

### **Parking on hills**

Generally, if you have a trailer attached to your vehicle, you should not park your vehicle on a hill.

However, if you ever have to park your trailer on a hill, here's how to do it:

1. Pull the vehicle into the parking space.  
Turn the steering wheel in the direction of the curb (right if headed down hill, left if headed up hill).
2. Shift the gear to P (Park).
3. Set the parking brake and shut off the vehicle.
4. Place wheel chocks under the trailer wheels on the down hill side of the wheels.
5. Start the vehicle, hold the brakes, shift to neutral, release the parking brake and slowly release the brakes until the trailer chocks absorb the load.
6. Reapply the brakes and parking brakes.
7. Shift the gear to P (Park) when the vehicle is parked on a uphill grade and in R (Reverse) on a downhill.
8. Shut off the vehicle and release the vehicle brakes but leave the parking brake set.



### **WARNING**

To prevent serious or fatal injury:

- **Do not get out of the vehicle without the parking brake firmly set. If you have left the engine running, the vehicle can move suddenly. You and others could be seriously or fatally injured.**
- **Do not apply the accelerator pedal to hold the vehicle on an uphill.**

### **Driving the vehicle after it has been parked on a hill**

1. With the gear in P (Park), apply your brakes and hold the brake pedal down while you:
  - Start your engine;
  - Shift into gear; and
  - Release the parking brake.
2. Slowly remove your foot from the brake pedal.
3. Drive slowly until the trailer is clear of the chocks.
4. Stop and have someone pick up and store the chocks.



### Maintenance When Towing a Trailer

Your vehicle will need service more often when you regularly pull a trailer. Important items to pay particular attention to include engine oil, transmission fluid, axle lubricant and cooling system fluid. Brake condition is another important item to frequently check. If you're trailering, it's a good idea to review these items before you start your trip. Don't forget to also maintain your trailer and hitch. Follow the maintenance schedule that accompanied your trailer and check it periodically. Preferably, conduct the check at the start of each day's driving. Most importantly, all hitch nuts and bolts should be tight.

#### **NOTICE**

**To prevent vehicle damage:**

- **Due to higher load during trailer usage, overheating might occur on hot days or during uphill driving. If the coolant gauge indicates over-heating, switch off the air conditioner and stop the vehicle in a safe area to cool down the engine.**
- **Do not switch off the engine while the coolant gauge indicates over-heating.**  
**(Keep the engine idle to cool down the engine)**
- **When towing check transmission fluid more frequently.**

## VEHICLE LOAD LIMIT

Two labels on your driver's door sill show how much weight your vehicle was designed to carry: the Tire and Loading Information Label and the Certification Label.

Before loading your vehicle, familiarize yourself with the following terms for determining your vehicle's weight ratings, from the vehicle's specifications and the Certification Label:

### **Base curb weight**

This is the weight of the vehicle including a full tank of fuel and all standard equipment. It does not include passengers, cargo, or optional equipment.

### **Vehicle curb weight**

This is the weight of your new vehicle when you picked it up from your dealer plus any aftermarket equipment.

### **Cargo weight**

This figure includes all weight added to the Base Curb Weight, including cargo and optional equipment.

### **GAW (Gross Axle Weight)**

This is the total weight placed on each axle (front and rear) - including vehicle curb weight and all payload.

### **GAWR (Gross Axle Weight Rating)**

This is the maximum allowable weight that can be carried by a single axle (front or rear). These numbers are shown on the Certification Label. The total load on each axle must never exceed its GAWR.

### **GVW (Gross Vehicle Weight)**

This is the Base Curb Weight plus actual Cargo Weight plus passengers.

### **GVWR (Gross Vehicle Weight Rating)**

This is the maximum allowable weight of the fully loaded vehicle (including all options, equipment, passengers and cargo). The GVWR is shown on the Certification Label located on the driver's door sill.

## The Loading Information Label

**A**

THE LOADING INFORMATION RENSEIGNEMENTS LESSENCIELS DE CHARGEMENT			
SEATING CAPACITY NOMBRE DE PLACES		TOTAL 7	FRONT 2 REAR 5
The combined weight of occupants and cargo should never exceed Le poids total des occupants et de la cargaison ne doit jamais dépasser			
TIRE PNEU	SIZE DIMENSIONS	COLD TIRE PRESSURE PRESSION DES PNEUS À FROID	SEE OWNER'S MANUAL FOR ADDITIONAL INFORMATION VOUS LE MANUEL DE L'USAGER POUR PLUS DE RENSEIGNEMENTS
FRONT AVANT	245/50R18	240kPa, 35psi	
REAR ARRIÈRE	245/50R18	240kPa, 35psi	
SPARE DE SECOURS	T155/90R18	420kPa, 60psi	

B1006EU01

**C**

THE LOADING INFORMATION RENSEIGNEMENTS LESSENCIELS DE CHARGEMENT			
SEATING CAPACITY NOMBRE DE PLACES		TOTAL 4	FRONT 2 REAR 2
The combined weight of occupants and cargo should never exceed Le poids total des occupants et de la cargaison ne doit jamais dépasser			
TIRE PNEU	SIZE DIMENSIONS	COLD TIRE PRESSURE PRESSION DES PNEUS À FROID	SEE OWNER'S MANUAL FOR ADDITIONAL INFORMATION VOUS LE MANUEL DE L'USAGER POUR PLUS DE RENSEIGNEMENTS
FRONT AVANT	245/50R18	240kPa, 35psi	
REAR ARRIÈRE	245/50R18	240kPa, 35psi	
SPARE DE SECOURS	T155/90R18	420kPa, 60psi	

B1006EU03

**B**

THE LOADING INFORMATION RENSEIGNEMENTS LESSENCIELS DE CHARGEMENT			
SEATING CAPACITY NOMBRE DE PLACES		TOTAL 7	FRONT 2 REAR 5
The combined weight of occupants and cargo should never exceed Le poids total des occupants et de la cargaison ne doit jamais dépasser			
TIRE PNEU	SIZE DIMENSIONS	COLD TIRE PRESSURE PRESSION DES PNEUS À FROID	SEE OWNER'S MANUAL FOR ADDITIONAL INFORMATION VOUS LE MANUEL DE L'USAGER POUR PLUS DE RENSEIGNEMENTS
FRONT AVANT	245/50R20	240kPa, 35psi	
REAR ARRIÈRE	245/50R20	240kPa, 35psi	
SPARE DE SECOURS	T155/90R18	420kPa, 60psi	

B1006EU02

**D**

THE LOADING INFORMATION RENSEIGNEMENTS LESSENCIELS DE CHARGEMENT			
SEATING CAPACITY NOMBRE DE PLACES		TOTAL 4	FRONT 2 REAR 2
The combined weight of occupants and cargo should never exceed Le poids total des occupants et de la cargaison ne doit jamais dépasser			
TIRE PNEU	SIZE DIMENSIONS	COLD TIRE PRESSURE PRESSION DES PNEUS À FROID	SEE OWNER'S MANUAL FOR ADDITIONAL INFORMATION VOUS LE MANUEL DE L'USAGER POUR PLUS DE RENSEIGNEMENTS
FRONT AVANT	245/50R20	240kPa, 35psi	
REAR ARRIÈRE	245/50R20	240kPa, 35psi	
SPARE DE SECOURS	T155/90R18	420kPa, 60psi	

B1006EU04

The label located on the driver's door sill gives the original tire size, cold tire pressures recommended for your vehicle, the number of people that can be in your vehicle and vehicle capacity weight.

### **Vehicle capacity weight**

1. 7 persons: 1173 lbs. (532 kg)
1. 8 persons: 1323 lbs. (600 kg)

Vehicle capacity weight is the maximum combined weight of occupants and cargo. If your vehicle is equipped with a trailer, the combined weight includes the tongue load.

### **Seating capacity**

1. Total : 7 persons (Front seat : 2 persons, Rear seat : 5 persons)
2. Total : 8 persons (Front seat : 2 persons, Rear seat : 6 persons)

Seating capacity is the maximum number of occupants including a driver, your vehicle may carry. However, the seating capacity may be reduced based upon the weight of all of the occupants, and the weight of the cargo being carried or towed. Do not overload the vehicle as there is a limit to the total weight, or load limit including occupants and cargo, the vehicle can carry.

### **Towing capacity**

With trailer brakes: 5000 lbs. (2268 kg)  
 Without trailer brakes: 1653 lbs. (750 kg)  
 Towing capacity is the maximum trailer weight including its cargo weight, your vehicle can tow.

### **Cargo capacity**

The cargo capacity of your vehicle will increase or decrease depending on the weight and the number of occupants and the tongue load, if your vehicle is equipped with a trailer.







### **Steps for determining correct load limit**

1. Locate the statement "The combined weight of occupants and cargo should never exceed XXX kg or XXX lbs." on your vehicle's placard.
2. Determine the combined weight of the driver and passengers that will be riding in your vehicle.
3. Subtract the combined weight of the driver and passengers from XXX lbs. or XXX kg.
4. The resulting figure equals the available amount of cargo and luggage load capacity. For example, if the "XXX" amount equals 1400 lbs. and there will be five 150 lb passengers in your vehicle, the amount of available cargo and luggage load capacity is 650 lbs. (1400 - 750 (5 x 150) = 650 lbs.)
5. Determine the combined weight of luggage and cargo being loaded on the vehicle. That weight may not safely exceed the available cargo and luggage load capacity calculated in Step 4.
6. If your vehicle will be towing a trailer, load from your trailer will be transferred to your vehicle. Consult this manual to determine how this reduces the available cargo and luggage load capacity of your vehicle.



### **WARNING**

**Do not overload the vehicle as there is a limit to the total weight, or load limit, including occupants and cargo, the vehicle can carry. Overloading can shorten the life of the vehicle. If the GVWR or the GAWR is exceeded, parts on the vehicle can break, and it can change the handling of your vehicle. These could cause you to lose control and result in an accident.**

<p><b>Example 1</b></p>	<p>Vehicle Capacity</p> <p>Maximum Load (1400 lbs.) (635 kg)</p>	<p>IV</p>	<p></p> <p>Passenger Weight (150 lbs. × 2 = 300 lbs.) (68 kg × 2 = 136 kg)</p>	<p>+</p>	<p></p> <p>Cargo Weight (1100 lbs.) (499 kg)</p>
<p><b>Example 2</b></p>	<p>Vehicle Capacity</p> <p>Maximum Load (1400 lbs.) (635 kg)</p>	<p>IV</p>	<p></p> <p>Passenger Weight (150 lbs. × 5 = 750 lbs.) (68 kg × 5 = 340 kg)</p>	<p>+</p>	<p></p> <p>Cargo Weight (650 lbs.) (295 kg)</p>
<p><b>Example 3</b></p>	<p>Vehicle Capacity</p> <p>Maximum Load (1400 lbs.) (635 kg)</p>	<p>IV</p>	<p></p> <p>Passenger Weight (172 lbs. × 5 = 860 lbs.) (78 kg × 5 = 390 kg)</p>	<p>+</p>	<p></p> <p>Cargo Weight (540 lbs.) (245 kg)</p>

## Certification label



OBH059070

The certification label is located on the driver's door sill at the center pillar and shows the maximum allowable weight of the fully loaded vehicle. This is called the GVWR (Gross Vehicle Weight Rating). The GVWR includes the weight of the vehicle, all occupants, fuel and cargo.

This label also tells you the maximum weight that can be supported by the front and rear axles, called Gross Axle Weight Rating (GAWR).

The total weight of the vehicle, including all occupants, accessories, cargo, and trailer tongue load must not exceed the Gross Vehicle Weight Rating (GVWR) or the Gross Axle Weight Rating (GAWR). To find out the actual loads on your front and rear axles, you need to go to a weigh station and weigh your vehicle. Be sure to spread out your load equally on both sides of the centerline.

## WARNING

### Overloading

- Never exceed the GVWR for your vehicle, the GAWR for either the front or rear axle and vehicle capacity weight. Exceeding these ratings can affect your vehicle's handling and braking ability, and cause an accident.
- Do not overload your vehicle. Overloading your vehicle can cause heat buildup in your vehicle's tires and possible tire failure, increased stopping distances and poor vehicle handling—all of which may result in a crash.

## **NOTICE**

Overloading your vehicle may cause damage. Repairs would not be covered by your warranty. Do not overload your vehicle.

## WARNING

If you carry items inside your vehicle (for example, suitcases, tools, packages, or anything else), they are moving as fast as the vehicle. If you have to stop or turn quickly, or if there is a crash, the items will keep going and can cause an injury if they strike the driver or a passenger.

- Put items in the cargo area of your vehicle. Try to spread the weight evenly.
- Do not stack items, like suitcases, inside the vehicle above the tops of the seats.
- Do not leave an unsecured child restraint in your vehicle.
- When you carry something inside the vehicle, secure it.

# 7. Driver Assistance System

Driver Assistance system functions can be updated by infotainment software update. Descriptions for each function of the system may differ from the owners' manual once updated. Refer to the user's manual provided in the infotainment system and the quick reference guide.

## Driving Safety

Forward Collision-Avoidance Assist (FCA) .....	7-2
Lane Keeping Assist (LKA).....	7-27
Blind-Spot Collision Warning (BCW) .....	7-33
Safe Exit Assist (SEA) .....	7-45
Manual Speed Limit Assist (MSLA).....	7-51
Intelligent Speed Limit Assist (ISLA) .....	7-54
Driver Attention Warning (DAW).....	7-60
Blind-Spot View Monitor (BVM).....	7-66

## Driving Convenience

Smart Cruise Control (SCC) .....	7-68
Navigation-Based Smart Cruise Control (NSCC) .....	7-86
Lane Following Assist (LFA) .....	7-93
Highway Driving Assist (HDA).....	7-97

## Parking Safety

Rear View Monitor (RVM) .....	7-110
Surround View Monitor (SVM) .....	7-114
Rear Cross-Traffic Collision-Avoidance Assist (RCCA) .....	7-119
Reverse Parking Distance Warning (PDW) .....	7-130
Forward/Reverse Parking Distance Warning (PDW) .....	7-135
Reverse Parking Collision-Avoidance Assist (PCA).....	7-140

## Parking Convenience

Remote Smart Parking Assist (RSPA) .....	7-147
--	-------

Declaration of Conformity.....	7-159
--------------------------------	-------

## FORWARD COLLISION-AVOIDANCE ASSIST (FCA)

### Basic function

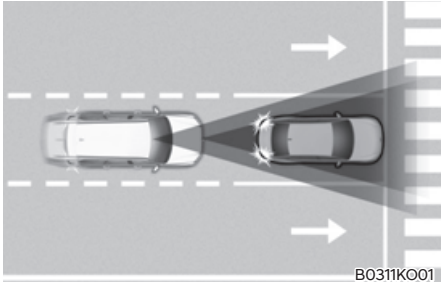

Forward Collision-Avoidance Assist is designed to help detect and monitor the vehicle ahead or help detect a pedestrian or cyclist in the roadway and warn the driver that a collision is imminent with a warning message and warning and application of emergency braking.

In addition, when driving at high speeds, Forward Collision-Avoidance Assist will help detect vehicles in front and adjacent lanes. If a collision is imminent when changing lanes, Forward Collision-Avoidance Assist will apply emergency braking to help prevent a collision. (if equipped)

### Junction Turning function

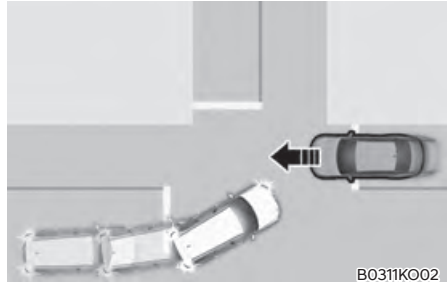

Junction Turning function helps avoid a collision with an oncoming vehicle in an adjacent lane when turning left at a crossroad with the turn signal on by applying emergency braking.

### Junction Crossing function (if equipped)

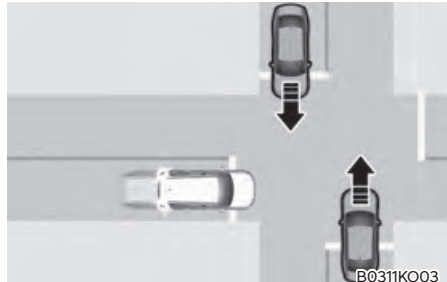

Junction Crossing function helps avoid a collision with oncoming vehicles on the left or right side when crossing an intersection by applying emergency braking.



### Lane-Change Oncoming function (if equipped)

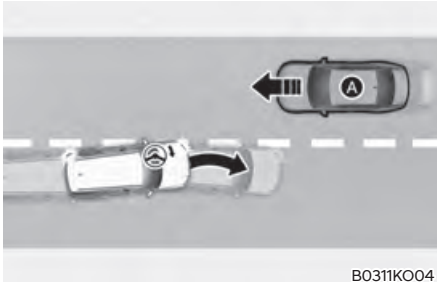

Ⓐ: Oncoming vehicle

Lane-Change Oncoming function helps avoid a collision with an oncoming vehicle when changing lanes by assisting the driver's steering.

### Lane-Change Side function (if equipped)

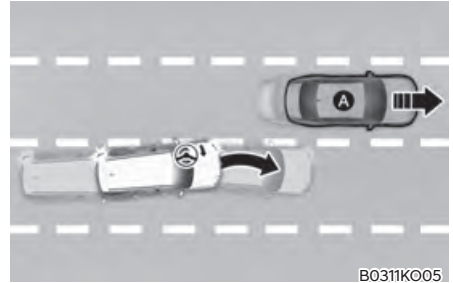

Ⓐ: Front-side vehicle

Lane-Change Side function helps avoid a collision with the vehicle ahead in the next lane when changing lanes by assisting the driver's steering.

**Evasive Steering Assist function (if equipped)**

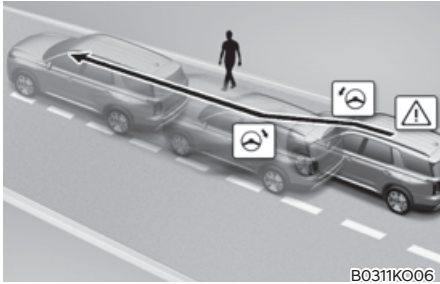

- Driver steering assist  
Evasive Steering Assist function helps avoid a collision with a vehicle, pedestrian or cyclist ahead in the same lane. When a risk of collision is detected, Evasive Steering Assist function will warn the driver and if the driver steers to avoid collision it will assist the driver's steering.
- Evasive steering assist  
Evasive Steering Assist function helps avoid a collision with a pedestrian or cyclist ahead in the same lane. When a risk of collision is detected, Evasive Steering Assist function will warn the driver and if there is space to avoid collision in the lane, it will assist the driver's steering.

**Detecting sensor**

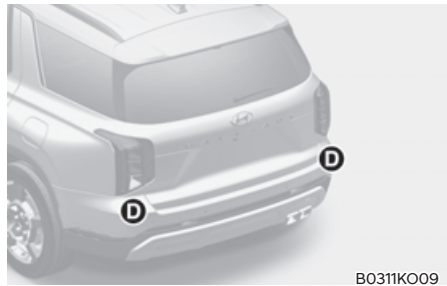
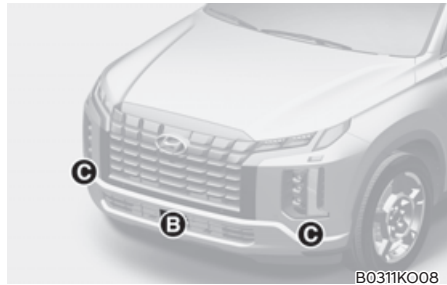

- (A): Front view camera, (B): Front radar,
- (C): Front corner radar (if equipped),
- (D): Rear corner radar (if equipped)

Refer to the picture above for the detailed location of the detecting sensors.



## CAUTION

Take the following precautions to maintain optimal performance of the detecting sensor:

- Never disassemble the detecting sensor or sensor assembly, or cause any damage to it.
- If the detecting sensors have been replaced or repaired, have the vehicle inspected by an authorized HYUNDAI dealer.
- Never install any accessories or stickers on the front windshield, or tint the front windshield.
- Exercise extreme caution to keep the front view camera dry.
- Never place any reflective objects (for example, white paper, mirror) over the dashboard.
- Do not place any objects near the front windshield or install any accessories on the front windshield. It can affect the performance of the defogging and defrosting function of the climate control system, which may prevent the Driver Assistance systems from operating.
- Do not apply license plate frame or objects, such as a bumper sticker, film or a bumper guard, near the front radar cover.
- Do not change the position of the license plate. The front radar's detection and control performance may be affected.
- Always keep the front radar and cover clean and free of dirt and debris.

Use only a soft cloth to wash the vehicle. Do not spray pressurized water directly on the sensor or sensor cover.

- If the radar or around the radar has been damaged or impacted in any way, Forward Collision-Avoidance Assist may not properly operate even though a warning message does not appear on the cluster. Have the vehicle inspected by an authorized HYUNDAI dealer.
- Use only genuine HYUNDAI parts to repair or replace a damaged front radar cover. Do not apply paint to the front radar cover.
- Vehicles equipped with front corner radar and/or rear corner radar
  - Do not apply license plate frame or objects, such as a bumper sticker, film or a bumper guard, near the front corner radar or rear corner radar.
  - The function may not work properly when the bumper has been replaced, or the surroundings of the front corner radar or rear corner radar has been damaged or paint has been applied.
  - If a trailer, carrier, etc., is installed, it may adversely affect the performance of the rear corner radar or Forward Collision-Avoidance Assist may not operate properly.

## Forward Collision-Avoidance Assist Settings

### Forward Safety

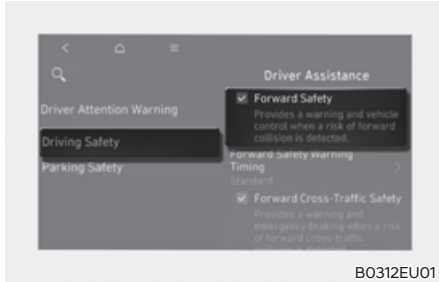

B0312EU01

With the engine on, select or deselect 'Driver Assistance → Driving Safety' from the Settings menu to set whether to use each function.

- If 'Forward Safety' is selected, Forward Collision-Avoidance Assist will warn the driver with a warning message, an audible warning and steering wheel vibration depending on the collision risk levels. Braking will be applied depending on the collision risk levels. If 'Forward Safety' is deselected, Forward Safety will turn off and the warning light  will illuminate on the cluster.

### Forward Cross-Traffic Safety (if equipped)

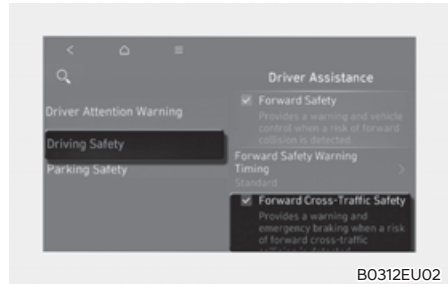

B0312EU02

With the engine on, select or deselect 'Driver Assistance → Driving Safety → Forward Cross-Traffic Safety' from the Settings menu to turn on Junction Crossing function and deselect to turn off the function.

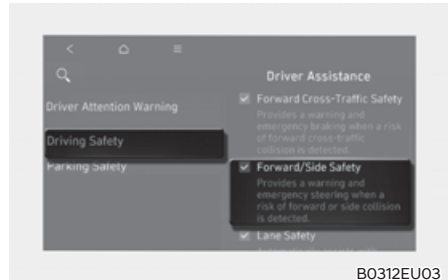

### Forward/Side Safety (if equipped)



B0312EU03

With the engine on, select or deselect 'Driver Assistance → Driving Safety → Forward/Side Safety' from the Settings menu to turn on Lane-Change Oncoming function, Lane-Change Side function, Evasive Steering Assist function and deselect to turn off the function.

If 'Forward/Side Safety' is selected, Forward Collision-Avoidance Assist will warn the driver, steering wheel vibration depending on the collision risk levels. Steering assist will be applied depending on the collision risk levels. If 'Forward/Side Safety' is deselected, Forward/Side Safety will turn off and the warning light  will illuminate on the cluster.

The driver can monitor Forward Collision-Avoidance Assist On/Off status from the Settings menu. If the warning light  or  remains ON when Forward Collision-Avoidance Assist is on, Have the vehicle inspected by an authorized HYUNDAI dealer.



## WARNING

**When the engine is restarted, Forward Collision-Avoidance Assist will always turn on. However, if 'Forward Safety', 'Forward-Cross Traffic Safety' and 'Forward/Side Safety' is deselected, the driver should always be aware of the surroundings and drive safely.**



## CAUTION

- The setting for Forward Safety includes 'Basic function' and 'Junction Turning'.
- The setting for Forward Cross Traffic Safety includes 'Junction Crossing'
- The setting for Forward/Side Safety includes 'Lane-Change Oncoming', 'Lane-Change Side' and 'Evasive Steering Assist' (if equipped).
- If 'Forward Safety' is deselected, Junction Crossing function will not operate even when 'Forward Cross-Traffic Safety' and 'Forward/Side Safety' is selected.
- Steering wheel vibration can be turned on or off. Select or deselect 'Driver Assistance → Haptic Warning' from the Settings menu.

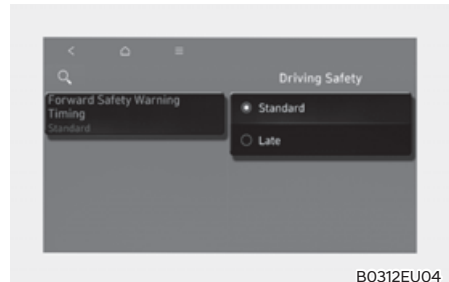

### Forward Safety Warning Timing

With the engine on, select 'Driver Assistance → Driving Safety → Forward Safety Warning Timing' from the Settings menu to change the initial warning activation time for Forward Collision-Avoidance Assist. The warning time can be set to either 'Standard' or 'Late'.

- Use 'Standard' in normal driving conditions. If the Warning Timing seems sensitive, change it to 'Late'.
- If 'Late' is selected, Forward Collision-Avoidance Assist, warns the driver more slowly.

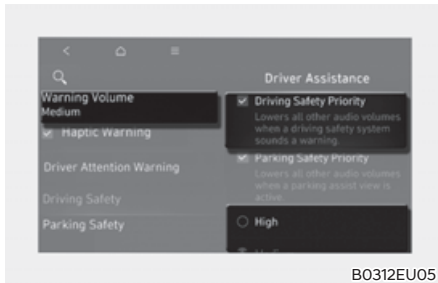

B0312EU05

### Warning Volume

With the vehicle on, select 'Driver Assistance → Warning Volume' or 'Sound → Driver Assistance' from the Settings menu to change the Warning Volume to 'High', 'Medium', 'Low' or 'Off' for Forward Collision-Avoidance Assist.

If 'Driving Safety Priority' is selected, the vehicle lowers all other audio volumes when the warning sounds for safe driving.



### CAUTION

- **The setting of the Warning Timing and Warning Volume applies to all functions of Forward Collision-Avoidance Assist.**
- **Even though 'Standard' is selected for Warning Timing, if the front vehicle suddenly stops, the warning may seem late.**
- **Select 'Late' for Warning Timing when traffic is light and when driving speed is slow.**



### Information

- **If the engine is restarted, Warning Timing and Warning Volume will maintain the last setting.**
- **If 'Off' is selected, steering wheel vibration will not turn off.**

## Forward Collision-Avoidance Assist Operation

### Basic function

The basic function for Forward Collision-Avoidance Assist is to warn and help control the vehicle depending on the collision risk level: 'Collision Warning', 'Emergency Braking' and 'Stopping vehicle and ending brake control'.

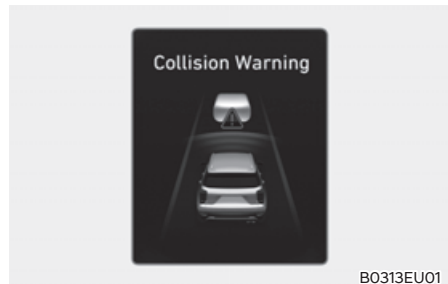

B0313EU01

### Collision Warning

- To warn the driver of a collision, the 'Collision Warning' warning message will appear on the cluster, an audible warning will sound and the steering wheel will vibrate.
- If a vehicle is detected in front, the function will operate when your vehicle speed is between approximately 6-124 mph (10-200 km/h).
- If a pedestrian or cyclist is detected in front, the function will operate when your vehicle speed is between approximately 6-53 mph (10-85 km/h).

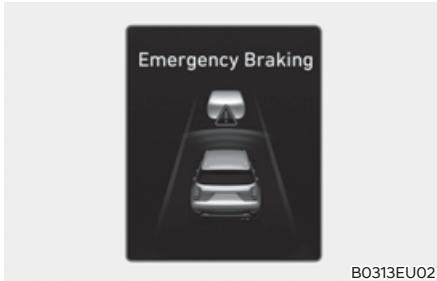

### Emergency Braking

To warn the driver that emergency braking will be assisted, the 'Emergency Braking' warning message will appear on the cluster, an audible warning will sound and the steering wheel will vibrate.

Emergency braking will operate under the following conditions.

- Vehicle

	Driving vehicle	Stopped vehicle
Weak braking power	Approximately 6-124 mph (10-200 km/h)*	
Strong braking power	Approximately 6-81 mph (10-130 km/h)*	Approximately 6-47 mph (10-75 km/h) (6-62 mph (10-100 km/h))*

\*: If Forward Collision Avoidance Assist judges that avoiding a collision is difficult even by changing the driving lane. The function operate range may decrease due to surroundings of the vehicle. (if equipped)

- Pedestrian or cyclist:

The function will operate when your vehicle speed is between approximately 6-40 mph (10-65 km/h).



### Stopping vehicle and ending brake control

- When the vehicle is stopped due to emergency braking, the 'Drive carefully' warning message will appear on the cluster.  
For your safety, the driver should depress the brake pedal immediately and check the surroundings.
- Brake control will end after the vehicle is stopped by emergency braking for approximately 2 seconds.

### ***Junction Turning function***

Junction Turning function will warn and help control the vehicle depending on the collision risk level: 'Collision Warning', 'Emergency Braking' and 'Stopping vehicle and ending brake control'



#### **Collision Warning**

- To warn the driver of a collision, the 'Collision Warning' warning message will appear on the cluster, an audible warning will sound and the steering wheel will vibrate.
- The function will operate when your vehicle speed is between approximately 6~19 mph (10~30 km/h) and the oncoming vehicle speed is between approximately 19~44 mph (30~70 km/h).

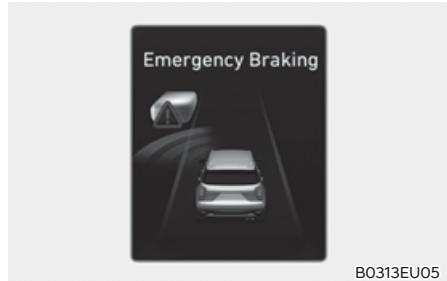

#### **Emergency Braking**

- To warn the driver that emergency braking will be assisted, the 'Emergency Braking' warning message will appear on the cluster, an audible warning will sound and the steering wheel will vibrate.
- In emergency braking situation, braking is assisted with strong braking power by the function to help prevent collision with the oncoming vehicle.
- The function will operate when your vehicle speed is between approximately 6-19 mph (10-30 km/h) and the oncoming vehicle speed is between approximately 19-44 mph (30-70 km/h).





B0313EU03

### Stopping vehicle and ending brake control

- When the vehicle is stopped due to emergency braking, the 'Drive carefully' warning message will appear on the cluster.  
For your safety, the driver should depress the brake pedal immediately and check the surroundings.
- Brake control will end after the vehicle is stopped by emergency braking for approximately 2 seconds.

### Junction Crossing function (if equipped)

Junction Crossing function will warn and help control the vehicle depending on collision risk level: 'Collision Warning', 'Emergency Braking' and 'Stopping vehicle and ending brake control'



B0313EU06

### Collision Warning

- To warn the driver of a collision, the 'Collision Warning' warning message will appear on the cluster, an audible warning will sound and the steering wheel will vibrate.
- The function will operate when your vehicle speed is between approximately 6~19 mph (10~30 km/h) and the crossing vehicle speed is between approximately 6~37 mph (10~60 km/h).

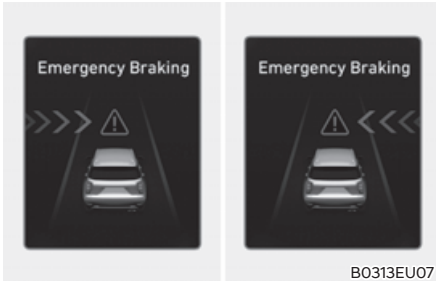

### Emergency Braking

- To warn the driver that emergency braking will be assisted, the 'Emergency Braking' warning message will appear on the cluster, an audible warning will sound and the steering wheel will vibrate.
- In emergency braking situation, braking is assisted with strong braking power by the function to help prevent collision with the crossing vehicle.
- The function will operate when your vehicle speed is between approximately 6~19 mph (10~30 km/h) and the crossing vehicle speed is between approximately 6~37 mph (10~60 km/h).



### Stopping vehicle and ending brake control

- When the vehicle is stopped due to emergency braking, the 'Drive carefully' warning message will appear on the cluster.  
For your safety, the driver should depress the brake pedal immediately and check the surroundings.
- Brake control will end after the vehicle is stopped by emergency braking for approximately 2 seconds.



### CAUTION

**If the collision angle with the crossing vehicle is beyond a certain range, Junction Crossing function warning and control may be late or may not operate.**

### ***Lane-Change Oncoming function (if equipped)***

Lane-Change Oncoming function will warn and help control the vehicle depending on collision risk level: 'Collision Warning' and 'Emergency Steering'



B0313EU04

#### **Collision Warning**

- To warn the driver of a collision, the 'Collision Warning' warning message will appear on the cluster, an audible warning will sound and the steering wheel will vibrate.
- The function will operate when your vehicle speed is between approximately 25-90 mph (40-145 km/h) and the oncoming vehicle speed is approximately above 6 mph (10 km/h) and the relative speed with your vehicle is approximately below 124 mph (200 km/h).

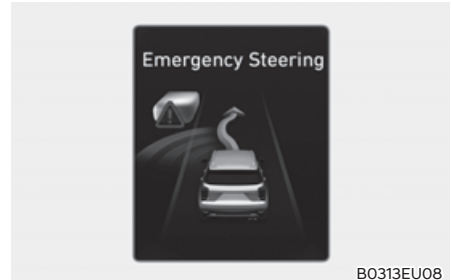

B0313EU08

#### **Emergency Steering**

- To warn the driver that emergency steering will be assisted, the 'Emergency Steering' warning message will appear on the cluster, an audible warning will sound and the steering wheel will vibrate.
- In emergency steering situation, steering is assisted by the function to help prevent collision with the oncoming vehicle.
- The function will operate when your vehicle speed is between approximately 25-90 mph (40-145 km/h) and the oncoming vehicle speed is approximately above 6 mph (10 km/h) and the relative speed with your vehicle is approximately below 124 mph (200 km/h).

### ***Lane-Change Side function (if equipped)***

Lane-Change Side function will warn and help control the vehicle depending on collision risk level: 'Collision Warning' and 'Emergency Steering'



#### **Collision Warning**

- To warn the driver of a collision, the 'Collision Warning' warning message will appear on the cluster, an audible warning will sound and the steering wheel will vibrate.
- The function will operate when your vehicle speed is between approximately 25–90 mph (40–145 km/h).



#### **Emergency Steering**

- To warn the driver that emergency steering will be assisted, the 'Emergency Steering' warning message will appear on the cluster, an audible warning will sound and the steering wheel will vibrate.
- In emergency steering situation, steering is assisted by the function to help prevent collision with the front-side vehicle.
- The function will operate when your vehicle speed is between approximately 25–90 mph (40–145 km/h) and front-side vehicle is driving.

## CAUTION

- Lane-Change Side function does not operate if the vehicle speed of the preceding vehicle from the front side is 0 mph (0 km/h).
- The detecting range of the front corner radar and the rear corner radar is determined by a standard road width, therefore, on a narrow road, Lane-Change Side function may detect other vehicles two lanes over and warn you. In contrast, on a wide road, Lane-Change Side function may not be able to detect a vehicle driving in the next lane and may not warn you.
- Collision-avoidance assist will be canceled under the following circumstances:
  - Your vehicle enters the next lane by a certain distance
  - Your vehicle is away from the collision risk
  - The steering wheel is sharply steered
  - The brake pedal is depressed
  - Forward Collision-avoidance assist is operating
- After Lane-Change Side function operation or lane change, you must drive to the center of the lane. Lane-Change Side function will not operate if the vehicle is not driven in the center of the lane.

## *Evasive Steering Assist function (if equipped)*

Evasive Steering Assist function will warn and control the vehicle with 'Emergency steering'.



B0313EU11

### Emergency Steering (Driver steering assist)

- To warn the driver that emergency steering will be assisted, the 'Emergency Steering' message will appear on the cluster, an audible warning will sound and the steering wheel will vibrate.
- If there is a risk of collision with a vehicle, pedestrian and cyclist in front, the steering will be assisted to help prevent collision when the driver steers the vehicle to avoid collision.
- The function will operate when your vehicle speed is between approximately 25-53 mph (40-85 km/h).



### Emergency Steering (Evasive steering assist)

- To warn the driver that emergency steering will be assisted, the 'Emergency Steering' message will appear on the cluster, an audible warning will sound and the steering wheel will vibrate.
- If there is high risk of collision with a pedestrian and cyclist in front, and the vehicle speed to operate emergency braking is within the operation range, the steering will be assisted to help prevent collision when there is space to avoid collision in the driving lane.
- The function will operate when your vehicle speed is between approximately 40-47 mph (65-75 km/h).

### CAUTION

- The steering wheel may turn automatically when emergency steering is operating.
- Emergency steering will automatically cancel when risk factors disappear. If necessary, the driver must steer the vehicle.
- Emergency steering may not operate or may cancel during operation if the steering wheel is held tight or steered in the opposite direction.
- When steering is assisted to avoid collision with a vehicle, pedestrian and cyclist, Evasive steering assist will be canceled if collisions with other objects (vehicles, pedestrians, or cyclists) are expected.
- Evasive steering assist may not operate if space to avoid collision in the driving lane is insufficient.

### Information

For more details on warning messages, refer to Collision Warning in “Basic Function”.

**WARNING**

- For your safety, change the Settings after parking the vehicle at a safe location.
- Forward Collision-Avoidance Assist does not operate in all situations or cannot avoid all collisions.
- The driver should hold the responsibility to control the vehicle. Do not solely depend on Forward Collision-Avoidance Assist. Rather, maintain a safe braking distance, and if necessary, depress the brake pedal to reduce driving speed or to stop the vehicle.
- Never deliberately operate Forward Collision-Avoidance Assist on people, objects, etc. It may cause serious injury or death.
- Forward Collision-Avoidance Assist may not operate if the driver depresses the brake pedal to avoid collision.
- During Forward Collision-Avoidance Assist operation, the vehicle may stop suddenly injuring passengers and shifting loose objects. Always have the seat belt on and keep loose objects secured.
- If any other system's warning message is displayed or audible warning is generated, Forward Collision-Avoidance Assist warning message may not be displayed and audible warning may not be generated.
- You may not hear the warning sound of Forward Collision-Avoidance Assist if the surrounding is noisy.
- Forward Collision-Avoidance Assist may turn off or may not operate properly or may operate unnecessarily depending on the road conditions and the surroundings.
- Even if there is a problem with Forward Collision-Avoidance Assist, the vehicle's basic braking performance will operate properly.
- During emergency braking, braking control by Forward Collision-Avoidance Assist will automatically cancel when the driver excessively depresses the accelerator pedal or sharply steers the vehicle.



## CAUTION

- Depending on the condition of the vehicle, pedestrian and cyclist in front and the surroundings, the speed range to operate Forward Collision-Avoidance Assist may reduce. Forward Collision-Avoidance Assist may only warn the driver, or it may not operate.
- Forward Collision-Avoidance Assist will operate under certain conditions by judging the risk level based on the condition of the oncoming vehicle, driving direction, speed and surroundings.
- Only Forward Collision-Avoidance Assist warning and collision mitigation are possible depending on the detectable distance.
- When a collision with a surrounding vehicle is expected, Lane-Change Oncoming, Lane-Change Side and Evasive Steering Assist functions will only warn the driver (if equipped).





## Information

- In a situation where collision is imminent, braking may be assisted by Forward Collision-Avoidance Assist when braking is insufficient by the driver.
- The images and colors in the cluster may differ depending on the cluster type or theme selected from the cluster.

## Forward Collision-Avoidance Assist Malfunction and Limitations

### Forward Collision-Avoidance Assist malfunction





When Forward Collision-Avoidance Assist is not working properly, the 'Check Forward Safety system' and 'Check Forward/Side Safety system' warning message will appear, and the ,  and  warning lights will illuminate on the cluster. Have the vehicle inspected by an HYUNDAI dealer.

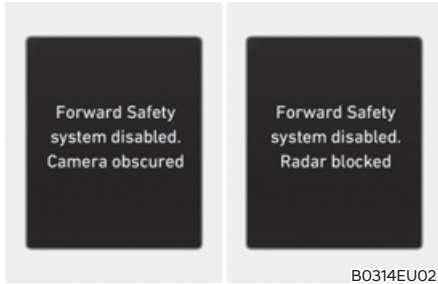

## Forward Collision-Avoidance Assist disabled



When the front windshield where the front view camera is located, front radar cover, bumper or sensor is covered with foreign material, such as snow or rain, it can reduce the detecting performance and temporarily limit or disable Forward Collision-Avoidance Assist.

If this occurs the 'Forward Safety system disabled. Camera obscured' or the 'Forward Safety system disabled. Radar blocked' warning message, and the ,  and  warning lights will illuminate on the cluster.

Forward Collision-Avoidance Assist will operate properly when snow, rain or foreign material is removed.

If Forward Collision-Avoidance Assist does not operate properly after obstruction (snow, rain, or foreign material) is removed (including trailer, carrier, etc., from the rear bumper), have the vehicle inspected by an authorized HYUNDAI dealer.

## WARNING

- Even though the warning message or warning light does not appear on the cluster, Forward Collision-Avoidance Assist may not properly operate.
- Forward Collision-Avoidance Assist may not properly operate in an area (for example, open terrain), where any objects are not detected after turning ON the engine.

### Limitations of Forward Collision-Avoidance Assist

Forward Collision-Avoidance Assist may not operate properly, or it may operate unexpectedly under the following circumstances:

- The detecting sensor or the surroundings are contaminated or damaged
- The temperature around the front view camera is high or low due to surrounding environment
- The camera lens is contaminated due to tinted, filmed or coated windshield, damaged glass, or sticky foreign material (sticker, bug, etc.) on the glass
- Moisture is not removed or frozen on the windshield
- Washer fluid is continuously sprayed, or the wiper is on
- Driving in heavy rain or snow, or thick fog
- The field of view of the front view camera is obstructed by sun glare
- Street light or light from an oncoming traffic is reflected on the wet road surface, such as a puddle on the road
- An object is placed on the dashboard
- Your vehicle is being towed

- The surrounding is very bright
- The surrounding is very dark, such as in a tunnel, etc.
- The brightness changes suddenly, for example when entering or exiting a tunnel
- The brightness outside is low, and the headlights are not on or are not bright
- Driving through steam, smoke or shadow
- Only part of the vehicle, pedestrian or cyclist is detected
- The vehicle in front is a bus, heavy truck, truck with an unusually shaped cargo, trailer, etc.
- The vehicle in front has no tail lights, tail lights are located unusually, etc.
- The brightness outside is low, and the tail lamps are not on or are not bright
- The rear of the front vehicle is small or the vehicle does not look normal, such as when the vehicle is tilted, overturned, or the side of the vehicle is visible, etc.
- The front vehicle's ground clearance is low or high
- A vehicle, pedestrian or cyclist suddenly cuts in front
- The bumper around the front radar is impacted, damaged or the front radar is out of position
- The temperature around the front radar is high or low
- Driving through a tunnel or iron bridge
- Driving in vast areas where there are few vehicles or structures (for example, desert, meadow, suburb, etc.)
- Driving near areas containing metal substances, such as a construction zone, railroad, etc.
- A material is near that reflects very well on the front radar, such as a guardrail, nearby vehicle, etc.
- The cyclist in front is on a bicycle made of material that does not reflect on the front radar
- The vehicle in front is detected late
- The vehicle in front is suddenly blocked by an obstacle
- The vehicle in front suddenly changes lane or suddenly reduces speed
- The vehicle in front is bent out of shape
- The front vehicle speed is fast or slow
- The vehicle in front steers in the opposite direction of your vehicle to avoid a collision
- With a vehicle in front, your vehicle changes lane at low speed
- The vehicle in front is covered with snow
- You are departing or returning to the lane
- Unstable driving
- You are on a roundabout and the vehicle in front is not detected

- You are continuously driving in a circle
- The vehicle in front has an unusual shape
- The vehicle in front is driving uphill or downhill
- The pedestrian or cyclist is not fully detected, for example, if the pedestrian is leaning over or is not fully walking upright
- The pedestrian or cyclist is wearing clothing or equipment that makes it difficult to detect



The illustration above shows the image the front view camera and front radar are capable of detecting as a vehicle, pedestrian and cyclist.

- The pedestrian or cyclist in front is moving very quickly
- The pedestrian or cyclist in front is short or is posing a low posture
- The pedestrian or cyclist in front has impaired mobility
- The pedestrian or cyclist in front is moving intersected with the driving direction

- There is a group of pedestrians, cyclists or a large crowd in front
- The pedestrian or cyclist is wearing clothing that easily blends into the background, making it difficult to detect
- The pedestrian or cyclist is difficult to distinguish from the similarly shaped structure in the surroundings
- You are driving by a pedestrian, cyclist, traffic signs, structures, etc., near the intersection
- Driving in a parking lot
- Driving through a tollgate, construction area, unpaved road, partial paved road, uneven road, speed bumps, etc.
- Driving on an incline road, curved road, etc.
- Driving through a roadside with trees or streetlights
- The adverse road conditions cause excessive vehicle vibrations while driving
- Your vehicle height is low or high due to heavy loads, abnormal tire pressure, etc.
- Driving through a narrow road where trees or grass are overgrown
- There is interference by electromagnetic waves, such as driving in an area with strong radio waves or electrical noise

### **Junction Crossing, Lane-Change Oncoming, Lane-Change Side, Evasive Steering Assist function (if equipped)**

- The temperature around the front corner radar or rear corner radar is high or low
- A trailer or carrier is installed around the rear corner radar
- The front corner radar or rear corner radar is covered with snow, rain, dirt, etc.
- The bumper around the front corner radar or rear corner radar is covered with objects, such as a bumper sticker, bumper guard, bike rack, etc.
- The bumper around the front corner radar or rear corner radar is impacted, damaged or the radar is out of position
- The front corner radar or rear corner radar is blocked by other vehicles, walls or pillars
- Driving on a highway (or motorway) ramp
- Driving on a road where the guardrail or wall is in double structure
- The other vehicle drives very close behind your vehicle, or the other vehicle passes by your vehicle in close proximity
- The speed of the other vehicle is very fast that it passes by your vehicle in a short time
- Your vehicle passes by the other vehicle
- Your vehicle has started at the same time as the vehicle next to you and has accelerated
- The vehicle in the next lane moves two lanes away from you, or when the vehicle two lanes away moves to the next lane from you
- A motorcycle or bicycle is detected
- A vehicle such as a flat trailer is detected
- A big vehicle such as a bus or truck is detected
- A small moving obstacle such as a pedestrian, animal, shopping cart or a baby stroller is detected
- A vehicle with low height such as a sports car is detected
- The lane is difficult to see due to foreign material, such as rain, snow, dust, sand, oil and water puddles
- The color of the lane marking is not distinguishable from the road
- There are markings on the road near the lane or the markings on the road looks similar to the lane markings
- The shadow is on the lane marking by a median strip, trees, guardrail, noise barriers, etc.
- The lane number increases or decreases, or the lane markings are crossing
- There are more than two lane markings on the road
- The lane markings are complicated or a structure substitutes for the lines, such as a construction area
- There are road markings, such as zigzag lanes, crosswalk markings and road signs
- The lane suddenly disappears, such as at the intersection
- The lane is very wide or narrow
- There is a curb or road edges without a lane
- The vehicle in front is driving with one side on the lane marking
- The distance to the front vehicle is extremely short

## WARNING

- Driving on a curved road

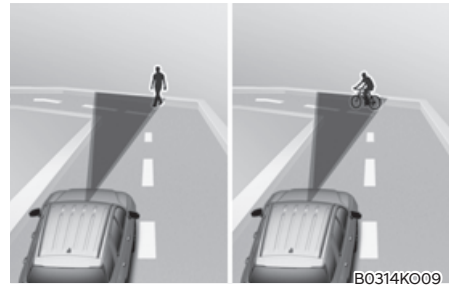
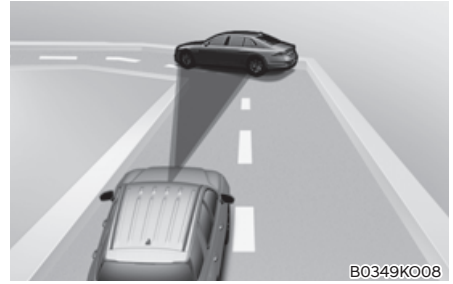
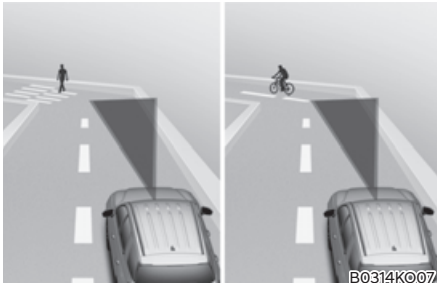
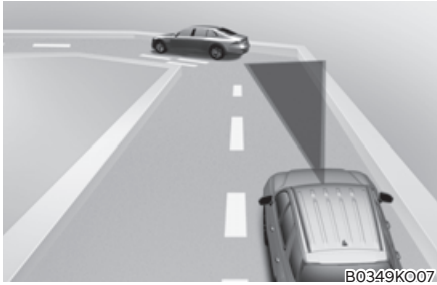

Forward Collision-Avoidance Assist may not detect other vehicles, pedestrians or cyclists in front of you when driving on curved roads adversely affecting the performance of the sensors. This may result in no warning, braking assist or steering assist when necessary.

When driving on a curve, you must maintain a safe braking distance, and if necessary, steer the vehicle and depress the brake pedal to reduce your driving speed in order to maintain a safe distance.

Forward Collision-Avoidance Assist may detect a vehicle, pedestrian or cyclist in the next lane or outside the lane when driving on a curved road. If this occurs, Forward Collision-Avoidance Assist may unnecessarily warn the driver and control the brake or steering wheel. Always check the traffic conditions around the vehicle.

- **Driving on an inclined road**

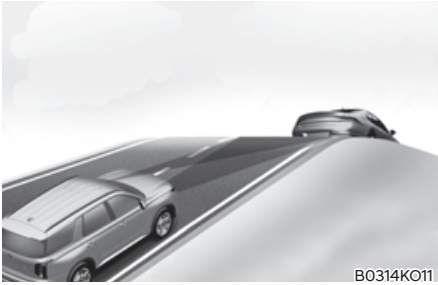

**Forward Collision-Avoidance Assist may not detect other vehicles, pedestrians or cyclists in front of you while driving uphill or downhill, adversely affecting the performance of the sensors.**

**This may result in unnecessary warning, braking assist or steering assist or no warning, braking assist or steering assist (if equipped) when necessary.**

**Also, vehicle speed may rapidly decrease when a vehicle, pedestrian or cyclist ahead is suddenly detected.**

**Always have your eyes on the road while driving uphill or downhill and if necessary, steer your vehicle and depress the brake pedal to reduce your driving speed in order to maintain a safe distance.**

- Changing lanes



B0314KO14

- Ⓐ: Your vehicle,
- Ⓑ: Lane changing vehicle

When a vehicle moves into your lane from an adjacent lane, it cannot be detected by the sensor until it is in the sensor's detection range. Forward Collision-Avoidance Assist may not immediately detect the vehicle when the vehicle changes lanes abruptly. In this case, you must maintain a safe braking distance, and if necessary, steer your vehicle and depress the brake pedal to reduce your driving speed in order to maintain a safe distance.



B0314KO15

- Ⓐ: Your vehicle,
- Ⓑ: Lane changing vehicle,
- Ⓒ: Same lane vehicle

When a vehicle in front of you merges out of the lane, Forward Collision-Avoidance Assist may not immediately detect the vehicle that is now in front of you. In this case, you must maintain a safe braking distance, and if necessary, steer your vehicle and depress the brake pedal to reduce your driving speed in order to maintain a safe distance.

- Detecting vehicle



If the vehicle in front of you has cargo that extends rearward from the cab, or when the vehicle in front of you has higher ground clearance, additional special attention is required. Forward Collision-Avoidance Assist may not be able to detect the cargo extending from the vehicle. In these instances, you must maintain a safe braking distance from the rearmost object, and if necessary, steer your vehicle and depress the brake pedal to reduce your driving speed in order to maintain distance.

 **WARNING**

- When you are towing a trailer or another vehicle, turn off Forward Collision-Avoidance Assist for safety reasons.
- Forward Collision-Avoidance Assist may operate if objects that are similar in shape or characteristics to vehicles, pedestrians and cyclists are detected.
- Forward Collision-Avoidance Assist does not operate on bicycles, or smaller wheeled objects, such as luggage bags, shopping carts, or strollers.

- Forward Collision-Avoidance Assist may not operate properly if interfered by strong electromagnetic waves.
- Forward Collision-Avoidance Assist may not operate for 15 seconds after the vehicle is started, or the front view camera is initialized.

 **Information**

This device complies with Part 15 of the FCC rules.

Operation is subject to the following three conditions:

1. This device may not cause harmful interference, and
2. This device must accept any interference received, including interference that may cause undesired operation.
3. Changes or modifications not expressly approved by the party responsible for compliance could void the user's authority to operate the device.

 **Information**

Radio frequency radiation exposure information:

This equipment complies with FCC radiation exposure limits set forth for an uncontrolled environment.

This equipment should be installed and operated with minimum distance of 8 in. (20 cm) between the radiator (antenna) and your body.

This transmitter must not be co-located or operating in conjunction with any other antenna or transmitter.



## LANE KEEPING ASSIST (LKA)

Lane Keeping Assist is designed to help detect lane markings (or road edges) while driving over a certain speed. Lane Keeping Assist will warn the driver if the vehicle leaves the lane without using the turn signal, or will automatically assist the driver's steering to help prevent the vehicle from departing the lane.

### Detecting sensor

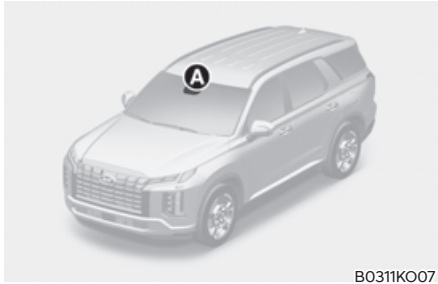

B0311K007

Ⓐ: Front view camera

The front view camera is used as a detecting sensor to detect lane markings (or road edges).

Refer to the picture above for the detailed location of the detecting sensor.



### CAUTION

For more details on the precautions of the front view camera, refer to “Forward Collision-Avoidance Assist (FCA)” section in this chapter.

## Lane Keeping Assist Settings

### Lane Safety

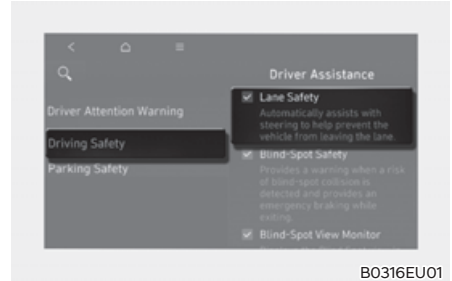

B0316EU01

With the engine on, select or deselect ‘Driver Assistance → Driving Safety’ from the Settings menu to set whether to use each function.

If ‘Lane Safety’ is selected, Lane Keeping Assist will automatically assist the driver's steering when lane departure is detected to help prevent the vehicle from moving out of its lane. If ‘Lane Safety’ is deselected, Lane keeping Assist will turn off and the (🚗) indicator light will turn off on the cluster.



### WARNING

- Lane Keeping Assist does not control the steering wheel when the vehicle is driven in the middle of the lane.
- The driver should always be aware of the surroundings. If ‘Lane Safety’ is deselected, Lane Keeping assist cannot assist you.

## Warning Volume

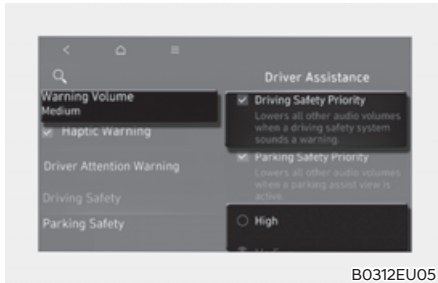

With the engine on, select 'Driver Assistance → Warning volume' or 'Sound → Driver Assistance' from the Settings menu to change the Warning Volume to 'High', 'Medium', 'Low' or 'Off' for Lane Keeping Assist.

If 'Driving Safety Priority' is selected, the vehicle lowers all other audio volumes when the warning sounds for safe driving. If 'Off' is selected, steering wheel vibration will not turn off.

### **i** Information

If you change the Warning Volume, the warning volume of other Driver Assistance systems may change.

## Turning Lane Keeping Assist On/Off



With the engine on, press and hold the Lane Driving Assist button located on the steering wheel to turn on Lane Keeping Assist. The grey or green  indicator light will illuminate on the cluster. Press and hold the button again to turn off the function.

### **i** Information

- When the Lane Driving Assist button is pressed and held, the Lane Safety setting turns off.
- If the engine is restarted, Lane Keeping Assist will maintain the last setting.

## Lane Keeping Assist Operation

### Warning and control

Lane Keeping Assist will warn and help control the vehicle with Lane Departure Warning and Lane Keeping Assist.

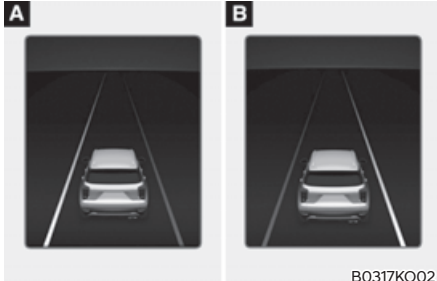

Ⓐ: Left, Ⓑ: Right

### Lane Departure Warning

- To warn the driver that the vehicle is departing from the projected lane in front, the green  indicator light will blink on the cluster, the lane line will blink on the cluster depending on which direction the vehicle is veering, and an audible warning will sound. Also, the steering wheel will vibrate.
- Lane Keeping Assist will operate when your vehicle speed is between approximately 40–120 mph (60–200 km/h).

### Lane Keeping Assist

- To warn the driver that the vehicle is departing from the projected lane in front, the green  indicator light will blink on the cluster, and the steering wheel will make adjustments to keep vehicle inside the lane.
- Lane Keeping Assist will operate when your vehicle speed is between approximately 40–120 mph (60–200 km/h).



### Hands-off warning

If the driver takes their hands off the steering wheel for several seconds, the 'Keep hands on the steering wheel' warning message will appear on the cluster, and an audible warning will sound in stages.

**WARNING**

- The steering wheel may not be assisted if the steering wheel is held very tight or the steering wheel is steered over a certain degree.
- Lane Keeping Assist does not operate at all times. It is the responsibility of the driver to safely steer the vehicle and to maintain the vehicle in its lane.
- The hands-off warning message may appear late depending on road conditions. Always have your hands on the steering wheel while driving.
- If the steering wheel is held very lightly, the hands-off warning message may appear because Lane Keeping Assist may not recognize that the driver has their hands on the steering wheel.
- If you attach objects to the steering wheel, the hands-off warning may not work properly.

**Information**

- For more details on instrument cluster settings, refer to “LCD display control” section in chapter 4.
- When lane markings (or road edges) are detected, the lane lines on the cluster will change from grey to white and the green  indicator light will illuminate.
- When the lane markings (or road edges) are detected and Highway Lane Change Assist is on, the lane lines on the cluster may change to green.

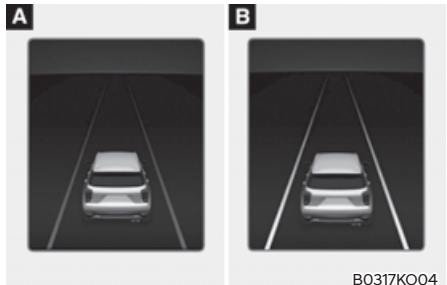

Ⓐ: Lane undetected, Ⓑ: Lane detected

- The images and colors in the cluster may differ depending on the cluster type or theme selected from the cluster.
- Even though the steering is assisted by Lane Keeping Assist, the driver may control the steering wheel.
- The steering wheel may feel heavier or lighter when the steering wheel is assisted by Lane Keeping Assist than when it is not.

## Lane Keeping Assist Malfunction and Limitations

### Lane Keeping Assist malfunction



When Lane Keeping Assist is not working properly, the 'Check Lane Safety system' warning message will appear and the yellow  indicator light will illuminate on the cluster. If this occurs, have the vehicle inspected by an authorized HYUNDAI dealer.

### Limitations of Lane Keeping Assist

Lane Keeping Assist may not operate properly or may operate unexpectedly under the following circumstances:

- The lane is contaminated or difficult to detect because:
  - The lane markings (or road edge) are covered with rain, snow, dirt, oil, etc.
  - The color of the lane marking (or road edge) is not distinguishable from the road
  - There are markings (or road edges) on the road near the lane or the markings (or road edges) on the road look similar to the lane markings (or road edge)
  - The lane marking (or road edge) is indistinct or damaged
  - The shadow is on the lane marking (or road edge) by a median strip, trees, guardrail, noise barriers, etc.

- The lane number increases or decreases, or the lane markings (or road edges) are crossing
- There are more than two lane markings (or road edges) on the road
- The lane markings (or road edges) are complicated or a structure substitutes for the lines, such as a construction area
- There are road markings, such as zigzag lanes, crosswalk markings and road signs
- The lane suddenly disappears, such as at the intersection
- The lane (or road width) is very wide or narrow
- There is a road edge without a lane
- There is a boundary structure in the roadway, such as a tollgate, sidewalk, curb, etc.
- The distance to the front vehicle is extremely short or the vehicle in front is covering the lane marking (or road edge)

### Information

**For more details on the limitations of the front view camera, refer to “Forward Collision-Avoidance Assist (FCA)” section in this chapter.**



## WARNING

Take the following precautions when using Lane Keeping Assist:

- The driver has the responsibility to safely drive and control the vehicle. Do not solely rely on Lane Keeping Assist and drive dangerously.
  - The operation of Lane Keeping Assist can be canceled or not work properly depending on road conditions and surroundings. Always be cautious while driving.
  - Refer to “Limitations of Lane Keeping Assist” if the lane is not detected properly.
  - When you are towing a trailer or another vehicle, turn off Lane Keeping Assist for safety reasons.
  - If the vehicle is driven at high speed, the steering wheel will not be controlled. The driver must always follow the speed limit when using Lane Keeping Assist.
  - If any other system’s warning message is displayed or audible warning is generated, Lane Keeping Assist warning message may not be displayed and audible warning may not be generated.
- You may not hear the warning sound of Lane Keeping Assist if the surrounding is noisy.
  - If you attach objects to the steering wheel, steering may not be assisted properly.
  - Lane Keeping Assist may not operate for 15 seconds after the vehicle is started, or the front view camera is initialized.
  - Lane Keeping Assist will not operate when:
    - The turn signal or hazard warning flasher is turned on.
    - The vehicle is not driven in the center of the lane when Lane Keeping Assist is turned on or right after changing a lane.
    - ESC (Electronic Stability Control) or VSM (Vehicle Stability Management) is activated.
    - The vehicle is driven on a sharp curve.
    - Vehicle speed is below 35 mph (55 km/h) or above 130 mph (210 km/h).
    - The vehicle makes sudden lane changes.
    - The vehicle brakes suddenly.

## BLIND-SPOT COLLISION WARNING (BCW) (IF EQUIPPED)

Blind-Spot Collision Warning is designed to help detect and monitor approaching vehicles in the driver's blind spot area and warn the driver of a possible collision with a warning message and audible warning.

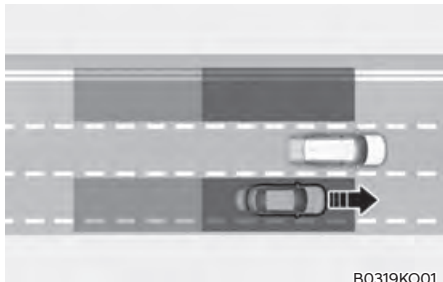

B0319KO01

Blind-Spot Collision Warning helps detect and informs the driver that a vehicle is in the blind spot.



### CAUTION

The detecting range may vary depending on the speed of your vehicle. Even if there is a vehicle in the blind spot area, Blind-Spot Collision Warning may not warn you when you pass by at high speeds.

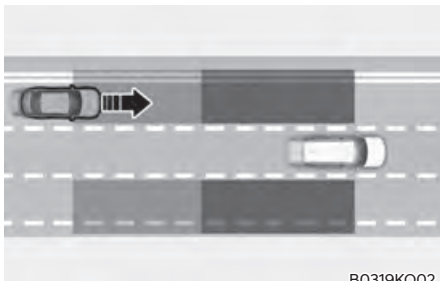

B0319KO02

Blind-Spot Collision Warning helps detect and informs the driver that a vehicle is approaching at high speed from the blind spot area.



### CAUTION

Warning timing may vary depending on the speed of the vehicle approaching at high speed.

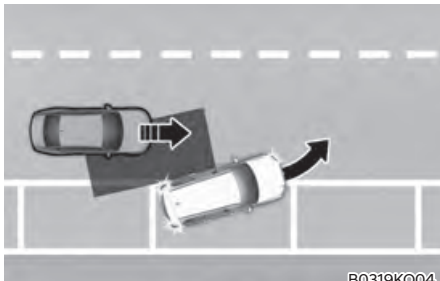

B0319KO04

When you are driving forward out of a parking space, if Blind-Spot Collision Warning judges that there is a collision risk with an approaching vehicle in the blind spot, it can help avoid collision by applying the brake.

### Detecting sensor

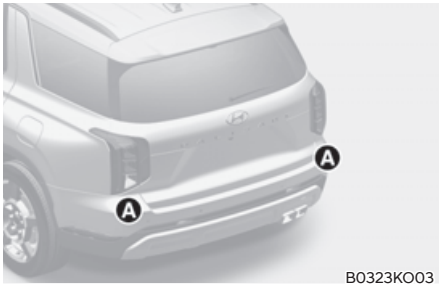

Ⓐ: Rear corner radar

Refer to the picture above for the detailed location of the detecting sensors.



### CAUTION

Take the following precautions to maintain optimal performance of the detecting sensor:

- Never disassemble the rear corner radar or radar assembly, or cause any damage to it.
- If the rear corner radar or near the radar has been damaged or impacted in any way, even though the warning message does not appear on the cluster, Blind-Spot Collision Warning may not operate properly. Have the vehicle inspected by an authorized HYUNDAI dealer.

- If the rear corner radars have been replaced or repaired, have the vehicle inspected by an authorized HYUNDAI dealer.
- Use only genuine HYUNDAI parts to repair the rear bumper where the rear corner radar is located.
- Rear bumper genuine parts with rear corner radars have proven their performance. Replacing or painting the rear bumper may result in poor performance of Blind-Spot Collision Warning. When the parts need to be replaced or modified, make sure to use qualified products.
- Do not apply license plate frame or objects, such as a bumper sticker, film or a bumper guard near the rear corner radar.
- Blind-Spot Collision Warning may not work properly if the bumper has been replaced, or the surroundings of the rear corner radar have been damaged or paint has been applied.
- If a trailer, carrier, etc., is installed, it may adversely affect the performance of the rear corner radar or Blind-Spot Collision Warning may not operate.



## Blind-Spot Collision Warning Settings

### *Blind-Spot Safety*

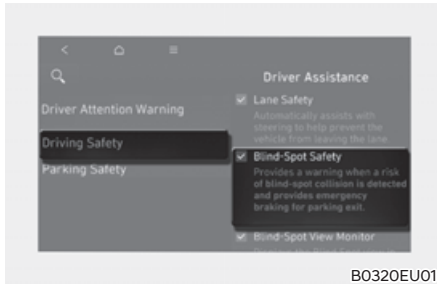

B0320EU01

With the engine on, select or deselect 'Driver Assistance → Driving Safety → Blind-Spot Safety' from the Settings menu to set whether to use each function.

- If 'Blind-Spot Safety' is selected, Blind-Spot Collision Warning will warn the driver with a warning message, an audible warning and steering wheel vibration depending on the collision risk levels. Braking assist will be applied for parking exit depending on the collision risk levels.



B0320EU02

When activating Blind-Spot Collision Warning or restarting the vehicle with this function activated, the warning light on the side mirrors will appear for approximately 3 seconds. When the vehicle is restarted with Blind-Spot Collision Warning inactivated, the warning message will appear on the cluster.



### **WARNING**

**The driver should always be aware of the surroundings and drive safely. If 'Blind-Spot Safety' is deselected, Blind-Spot Collision Warning cannot assist you.**



### **Information**

**If the engine is restarted, Blind-Spot Collision Warning will maintain the last setting.**

### Warning Volume

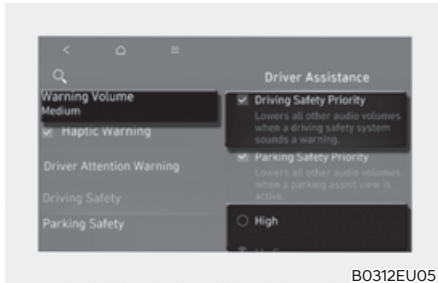

B0312EU05

With the engine on, select 'Driver Assistance → Warning volume' or 'Sound → Driver Assistance' from the Settings menu to change the Warning Volume to 'High', 'Medium', 'Low' or 'Off' for Blind-Spot Collision Warning.

If 'Driving Safety Priority' is selected, the vehicle lowers all other audio volumes when the warning sounds for safe driving.

### Information

If you change the Warning Volume, the Warning Volume of other Driver Assistance systems may change.

### CAUTION

The setting of the Warning Volume applies to all functions of Blind-Spot Collision Warning.

### Blind-Spot Collision Warning Operation

#### Driving-Warning

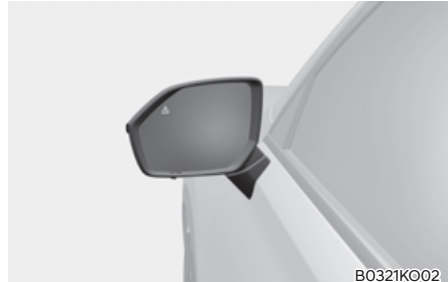

B0321K002

- To warn the driver a vehicle is detected, the warning light on the side view mirror and head-up display (if equipped) will illuminate.
- Blind-Spot Collision Warning will operate when your vehicle speed is above 12 mph (20 km/h) and the speed of the vehicle in the blind spot area is above 7 mph (10 km/h).
- Collision warning will operate when the turn signal is turned on in the direction of the detected vehicle.
- To warn the driver of a collision, the warning light on the side view mirror and head-up display (if equipped) will blink. At the same time, an audible warning will sound and the steering wheel will vibrate.
- When the turn signal is turned off, the collision warning will be canceled and Blind-Spot Collision Warning will return to vehicle detection state.

## WARNING

- The detecting range of the rear corner radar is determined by a standard road width, therefore, on a narrow road, Blind-Spot Collision Warning may detect other vehicles two lanes over and warn you. In contrast, on a wide road, Blind-Spot Collision Warning may not be able to detect a vehicle driving in the next lane and may not warn you.
- When the hazard warning flasher is on, the collision warning by the turn signal will not operate.

## Information

The images and colors in the instrument cluster may differ depending on the cluster type or theme selected from the settings menu.

## *Collision-avoidance assist (while parallel parking exit)*



- To warn the driver of a collision, the warning light on the side view mirror will blink and a warning message will appear on the cluster. At the same time, an audible warning will sound, warning light on the head-up display (if equipped) will blink and the steering wheel will vibrate.
- Emergency braking will be assisted to help prevent collision with the vehicle in the blind spot area.
- Blind-Spot Collision Warning will operate when your vehicle speed is below 2 mph (3 km/h) and the speed of the vehicle in the blind spot area is above 3 mph (5 km/h).



- When the vehicle is stopped due to emergency braking, the 'Drive carefully' warning message will appear on the cluster.  
For your safety, the driver should depress the brake pedal immediately and check the surroundings.
- Brake control will end after the vehicle is stopped by emergency braking for approximately 2 seconds.

### **WARNING**

Take the following precautions when using Blind-Spot Collision Warning:

- For your safety, only change the Settings after parking the vehicle at a safe location.
- If any other system's warning message is displayed or audible warning is generated, Blind-Spot Collision Warning warning message may not be displayed and audible warning may not be generated.
- You may not hear the warning sound of Blind-Spot Collision Warning if the surrounding is noisy.
- Blind-Spot Collision Warning may not operate if the driver applies the brake pedal to avoid collision.

- When Blind-Spot Collision Warning is operating, braking control by the function will automatically cancel when the driver excessively depresses the accelerator pedal or sharply steers the vehicle.
- During Blind-Spot Collision Warning operation, the vehicle may stop suddenly injuring passengers and shifting loose objects. Always have the seat belt on and keep loose objects secured.
- Even if there is a problem with Blind-Spot Collision Warning, the vehicle's basic braking performance will operate properly.
- Blind-Spot Collision Warning does not operate in all situations or cannot avoid all collisions.
- Blind-Spot Collision Warning may warn the driver late or may not warn the driver depending on the road and driving conditions.
- Driver should maintain control of the vehicle at all times. Do not depend on Blind-Spot Collision Warning. Maintain a safe braking distance, and if necessary, depress the brake pedal to reduce driving speed or to stop the vehicle.
- Never operate Blind-Spot Collision Warning on people, animal, objects, etc. It may cause serious injury or death.

### **WARNING**

The brake control may not operate properly depending on the status of ESC (Electronic Stability Control).

There will only be a warning when:

- The ESC (Electronic Stability Control) warning light is on
- ESC (Electronic Stability Control) is engaged in a different function

## Blind-Spot Collision Warning Malfunction and Limitations

### ***Blind-Spot Collision Warning malfunction***

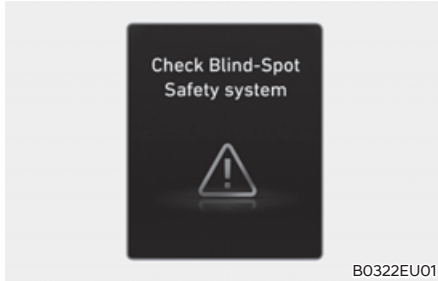

When Blind-Spot Collision Warning is not working properly, the 'Check Blind-Spot Safety system' warning message will appear on the cluster for several seconds, and the master (⚠) warning light will illuminate on the cluster. If this occurs, have the vehicle inspected by an authorized HYUNDAI dealer.

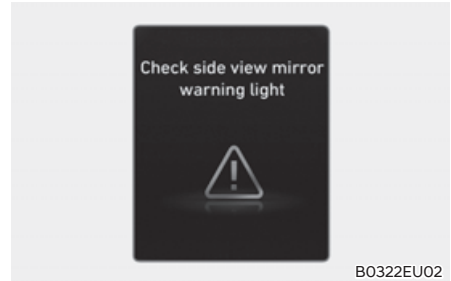

When the side view mirror warning light is not working properly, the 'Check side view mirror warning light' warning message will appear on the cluster for several seconds, and the master (⚠) warning light will illuminate on the cluster. If this occurs, have the vehicle inspected by an authorized HYUNDAI dealer.

### **Blind-Spot Collision Warning disabled**

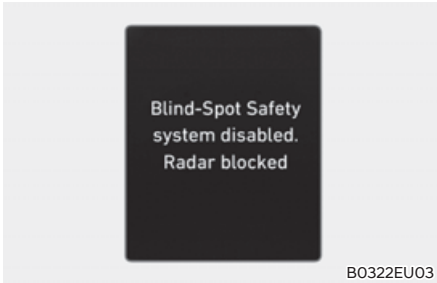

When the rear bumper around the rear corner radar or sensor is covered with foreign material, such as snow or rain, or installing a trailer or carrier, it can reduce the detecting performance and temporarily limit or disable Blind-Spot Collision Warning.

If this occurs, the 'Blind-Spot Safety system disabled. Radar blocked' warning message will appear on the cluster.

Blind-Spot Collision Warning will operate properly when such foreign material or trailer, etc., is removed, and then the engine is restarted.

If Blind-Spot Collision Warning does not operate properly after it is removed, have the vehicle inspected by an authorized HYUNDAI dealer.

### **WARNING**

- Even though the warning message does not appear on the cluster, Blind-Spot Collision Warning may not properly operate.
- Blind-Spot Collision Warning may not properly operate in an area (for example, open terrain) where any objects are not detected right after the engine is turned on, or when the detecting sensor is blocked with foreign material right after the engine is turned on.

### **CAUTION**

**Turn off Blind-Spot Collision Warning to install or remove a trailer, carrier, or another attachment. Turn on Blind-Spot Collision Warning when finished.**

### ***Limitations of Blind-Spot Collision Warning***

Blind-Spot Collision Warning may not operate properly, or it may operate unexpectedly under the following circumstances:

- There is inclement weather, such as heavy snow, heavy rain, etc.
- The rear corner radar is covered with snow, rain, dirt, etc.
- The temperature around the rear corner radar is high or low
- Driving on a highway ramp
- The road pavement (or the peripheral ground) abnormally contains metallic components (for example, possibly due to subway construction)
- There is a fixed object near the vehicle, such as sound barriers, guardrails, central dividers, entry barriers, street lamps, signs, tunnels, walls, etc. (including double structures)
- Driving in vast areas where there are few vehicles or structures (for example, desert, meadow, suburb, etc.)
- Driving through a narrow road where trees or grass are overgrown
- Driving on a wet road surface, such as a puddle on the road
- The other vehicle drives very close behind your vehicle, or the other vehicle passes by your vehicle in close proximity
- The speed of the other vehicle is very fast that it passes by your vehicle in a short time
- Your vehicle passes by the other vehicle
- Your vehicle changes lane
- Your vehicle has started at the same time as the vehicle next to you and has accelerated
- The vehicle in the next lane moves two lanes away from you, or when the vehicle two lanes away moves to the next lane from you
- A trailer, carrier or other attachment is installed around the rear corner radar
- The bumper around the rear corner radar is covered with objects, such as a bumper sticker, bumper guard, bike rack, etc.
- The bumper around the rear corner radar is impacted, damaged or the radar is out of position
- Your vehicle height is low or high due to heavy loads, abnormal tire pressure, etc.

Blind-Spot Collision Warning may not operate properly, or it may operate unexpectedly when the following objects are detected:

- A motorcycle or bicycle is detected
- A vehicle such as a flat trailer is detected
- A big vehicle such as a bus or truck is detected
- A moving obstacle such as a pedestrian, animal, shopping cart or a baby stroller is detected
- A vehicle with low height such as a sports car is detected

Braking control may not work, driver's attention is required in the following circumstances:

- The vehicle severely vibrates while driving over a bumpy road, uneven road or concrete patch
- Driving on a slippery surface due to snow, water puddle, ice, etc.
- The tire pressure is low or a tire is damaged
- The braking system has been modified
- The vehicle makes abrupt lane changes

### **i** Information

For more details on the limitations of the front view camera, refer to “Forward Collision-Avoidance Assist (FCA)” and “Lane Keeping Assist (LKA)” section in this chapter.

### **!** WARNING

- Driving on a curved road



**Blind-Spot Collision Warning may not operate properly when driving on a curved road. The function may not detect the vehicle in the next lane.**

**Always pay attention to road and driving conditions while driving.**



**Blind-Spot Collision Warning may not operate properly when driving on a curved road. The function may recognize a vehicle in the same lane.**

**Always pay attention to road and driving conditions while driving.**



- Driving where the road is merging/dividing

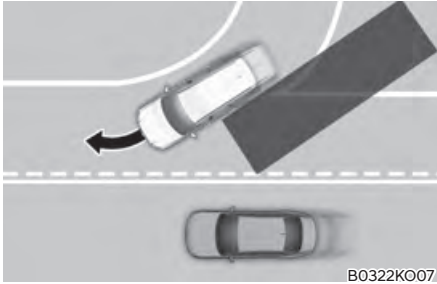

Blind-Spot Collision Warning may not operate properly when driving where the road merges or divides. The function may not detect the vehicle in the next lane.

Always pay attention to road and driving conditions while driving.

- Driving on an inclined road

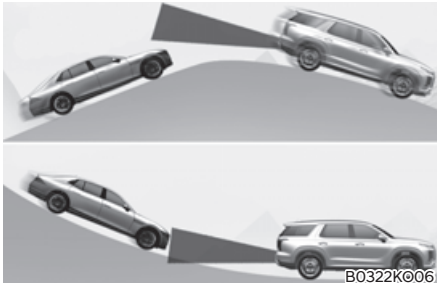

Blind-Spot Collision Warning may not operate properly when driving on a slope. The function may not detect the vehicle in the next lane or may incorrectly detect the ground or structure.

Always pay attention to road and driving conditions while driving.

- Driving where the heights of the lanes are different

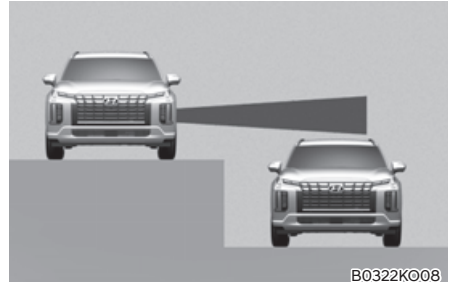

Blind-Spot Collision Warning may not operate properly when driving where the heights of the lanes are different. The function may not detect the vehicle on a road with different lane heights (underpass joining section, grade separated intersections, etc.).

Always pay attention to road and driving conditions while driving.

## WARNING

- When you are towing a trailer or another vehicle, make sure that you turn off Blind-Spot Collision Warning.
- Blind-Spot Collision Warning may not operate properly if interfered by strong electromagnetic waves.
- Blind-Spot Collision Warning may not operate for 3 seconds after the vehicle is started, or the rear corner radars are initialized.

**i** Information

This device complies with Part 15 of the FCC rules.

Operation is subject to the following three conditions:

1. This device may not cause harmful interference, and
2. This device must accept any interference received, including interference that may cause undesired operation.
3. Changes or modifications not expressly approved by the party responsible for compliance could void the user's authority to operate the device.

**i** Information

Radio frequency radiation exposure information:

This equipment complies with FCC radiation exposure limits set forth for an uncontrolled environment.

This equipment should be installed and operated with minimum distance of 8 in. (20 cm) between the radiator (antenna) and your body.

This transmitter must not be co-located or operating in conjunction with any other antenna or transmitter.

## SAFE EXIT ASSIST (SEA) (IF EQUIPPED)

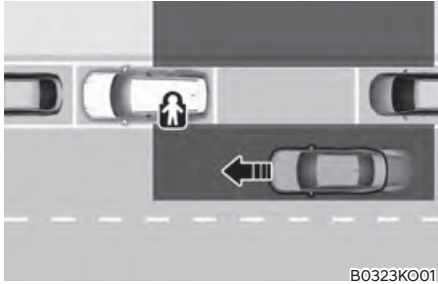

After the vehicle stops, when an approaching vehicle from the rear area is detected after a passenger opens the door, Safe Exit Assist will warn the driver with a warning message and an audible warning to help prevent a collision.



When the electronic child safety lock button is in the LOCK position and an approaching vehicle from the rear area is detected, the electronic child safety lock button will not unlock even if the driver presses the button to prevent the rear doors from opening.

### CAUTION

- Warning timing may vary depending on the speed of the approaching vehicle.
- Do not use Safe Exit Assist instead of the electronic child safety lock button. To protect rear seat passengers, use the electronic child safety lock button. For more details on, refer to "Electronic Child Safety Lock" section in chapter 5.

### Detecting sensor

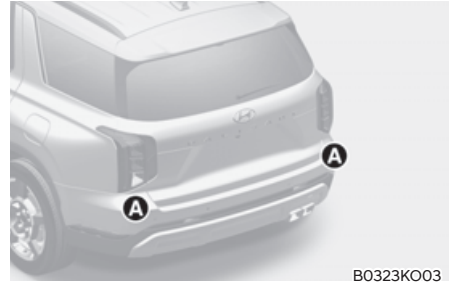

: Rear corner radar

Refer to the picture above for the detailed location of the detecting sensors.

### CAUTION

For more details on the precautions of the rear corner radars, refer to "Blind-Spot Collision Warning (BCW)" section in this chapter.

## Safe Exit Assist Settings

### Exit Safety

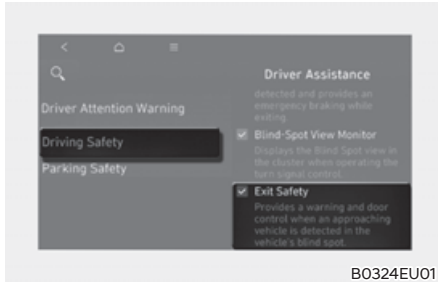

With the engine on, select 'Driver Assistance → Driving Safety → Exit Safety' from the Settings menu to turn on Safe Exit Assist and deselect to turn off the function.

### WARNING

The driver should always be aware of the surroundings. If 'Exit Safety' is deselected, Safe Exit Assist cannot assist you.

### Information

If the engine is restarted, Safe Exit Assist will maintain the last setting.

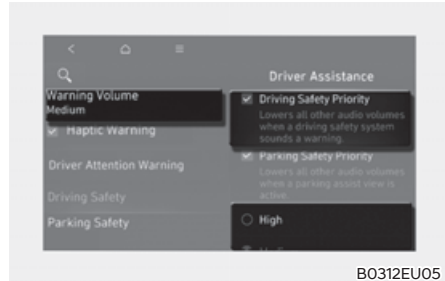

### Warning Volume

With the engine on, select 'Driver Assistance → Warning volume' or 'Sound → Driver Assistance' from the Settings menu to change the Warning Volume 'High', 'Medium', 'Low' or 'Off' for Safe Exit Assist.

If 'Driving Safety Priority' is selected, the vehicle lowers all other audio volumes when the warning sounds for safe driving.

### Information

- If you change the Warning Volume, the Warning Volume of other Driver Assistance systems may change.
- If 'Off' is selected, the Warning Volume of Safe Exit Assist will not turn off, but the volume will sound as 'Low'.

### CAUTION

The setting of the Warning Volume applies to all functions of Safe Exit Assist.

## Safe Exit Assist Operation

Safe Exit Assist will warn and control the vehicle with Collision warning when exiting vehicle and Safe Exit Assist linked with Electronic child safety lock.

### Warning and control

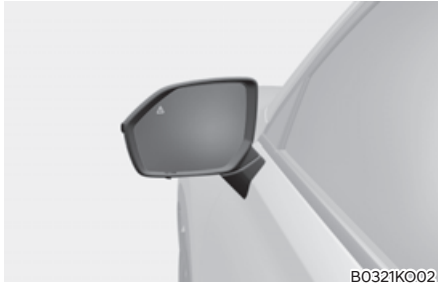

B0321KO02



B0325EU01

### Collision warning when exiting vehicle

- When an approaching vehicle from the rear is detected at the moment a door is opened, the 'Collision Warning' warning message will appear on the cluster, and an audible warning will sound.
- Safe Exit Assist will warn the driver when your vehicle speed is below 2 mph (3 km/h), and the speed of the approaching vehicle from the rear is above 4 mph (6 km/h).

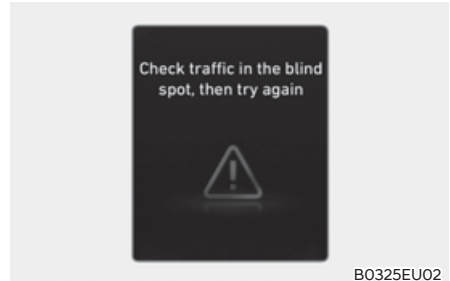

B0325EU02

### Safe Exit Assist linked with Electronic child safety lock

- When Electric child safety lock is operating and an approaching vehicle from the rear area is detected, the rear doors cannot be unlocked even if the driver tries to unlock the rear doors using the electronic child safety lock button. The warning light on the side view mirror will blink and the 'Check traffic in the blind spot, then try again' warning message will appear on the cluster.
- Safe Exit Assist will warn the driver when vehicle speed is below 2 mph (3 km/h) and the speed of the approaching vehicle from the rear is above 4 mph (6 km/h).

## **i** Information

For more details on electric child safety lock button, refer to "Electronic Child Safety Lock" section in chapter 5.



### CAUTION

If the driver presses the electronic child lock button again within 10 seconds after the warning message appears, Safe Exit Assist judges that the driver has unlocked the doors acknowledging the rear status. The electronic child safety lock will turn off (button indicator OFF) and the rear doors will unlock. Always check the surroundings before turning off the electronic child safety lock button.



### Information

If a rear door is opened from the outside, it will open regardless of Safe Exit Assist operation.



### WARNING

Take the following precautions when using Safe Exit Assist:

- For your safety, only change the Settings after parking the vehicle at a safe location.
- If any other system's warning message is displayed or audible warning is generated, Safe Exit Assist warning message may not be displayed and audible warning may not be generated.
- You may not hear the warning sound of Safe Exit Assist if the surroundings are noisy.
- Safe Exit Assist does not operate in all situations or cannot prevent all collisions.
- Safe Exit Assist may warn the driver late or may not warn the driver depending and the road and driving conditions. Always check vehicle surroundings.
- The driver and passengers are responsible for accidents that occur while exiting the vehicle. Always check the surroundings before you exit the vehicle.
- Never deliberately operate Safe Exit Assist. Doing so may lead to serious injury or death.



### Information

- After the engine is turned off, Safe Exit Assist operates approximately for 3 minutes, but turns off immediately if the doors are locked.
- The images and colors in the instrument cluster may differ depending on the cluster type or theme selected from the settings menu.

## Safe Exit Assist Malfunction and Limitations

### Safe Exit Assist malfunction

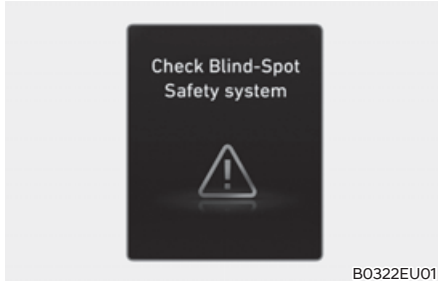

When Safe Exit Assist is not working properly, the 'Check Blind-Spot Safety system' warning message will appear on the cluster for several seconds, and the master (⚠) warning light will illuminate on the cluster. If this occurs, have the vehicle inspected by an authorized HYUNDAI dealer.

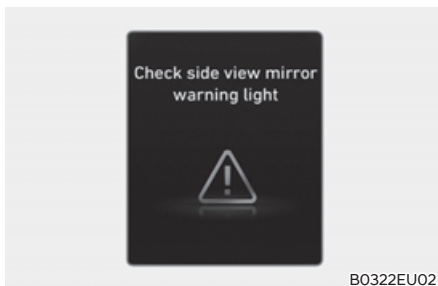

When the side view mirror warning light is not working properly, the 'Check side view mirror warning light' warning message will appear on the cluster for several seconds, and the master (⚠) warning light will illuminate on the cluster. If this occurs, have the vehicle inspected by an authorized HYUNDAI dealer.

### Safe Exit Assist disabled

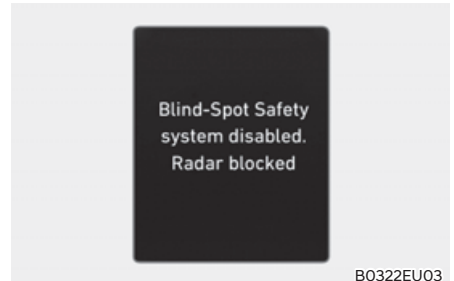

When the rear bumper around the rear corner radar or sensor is covered with foreign material, such as snow or rain, or installing a trailer or carrier, it can reduce the detecting performance and temporarily limit or disable Safe Exit Assist.

If this occurs, the 'Blind-Spot Safety system disabled. Radar blocked' warning message will appear on the cluster.

Safe Exit Assist will operate properly when such foreign material or trailer, etc., is removed, and then the engine is restarted.

If Safe Exit Assist does not operate properly after it is removed, have the vehicle inspected by an authorized HYUNDAI dealer.



## WARNING

- Even though the warning message does not appear on the cluster, Safe Exit Assist may not properly operate.
- Safe Exit Assist may not properly operate in an area (for example, open terrain) where any objects are not detected right after the engine is turned on, or when the detecting sensor is blocked with foreign material right after the engine is turned on.



## CAUTION

Turn off Safe Exit Assist to install or remove a trailer, carrier, or another attachment. Turn on Safe Exit Assist when finished.

## *Limitations of Safe Exit Assist*

Safe Exit Assist may not operate properly, or it may operate unexpectedly under the following circumstances:

- Getting out of the vehicle where trees or grass are overgrown
- Getting out of the vehicle where the road is wet
- The approaching vehicle is very fast or very slow



## Information

For more details on the limitations of the rear corner radar, refer to “Blind-Spot Collision Warning (BCW)” section in this chapter.



## WARNING

- Safe Exit Assist may not operate properly if interfered by strong electromagnetic waves.
- Safe Exit Assist may not operate for 3 seconds after the vehicle is started, or the rear corner radars are initialized.



## MANUAL SPEED LIMIT ASSIST (MSLA)

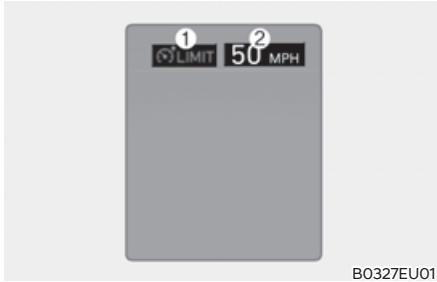

B0327EU01

- ① Speed Limit indicator
- ② Set speed

You can set the speed limit when you do not want to drive over a specific speed.



If you drive over the preset speed limit, Manual Speed Limit Assist will operate (set speed limit will blink and chime will sound) until the vehicle speed returns within the speed limit.

### Manual Speed Limit Assist Operation

#### Setting speed limit



B0328K001

1. Press and hold Driving Assist (  ) button at the desired speed. The Speed Limit (  ) LIMIT indicator will illuminate on the cluster.

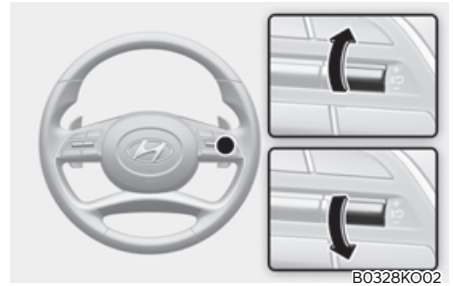

B0328K002

2. Push the + switch up or - switch down, and release it at the desired speed.  
Push the + switch up or - switch down and hold it. The speed will increase or decrease to the nearest multiple of five (multiple of ten in km/h) at first, and then increase or decrease by 5 mph (10 km/h).

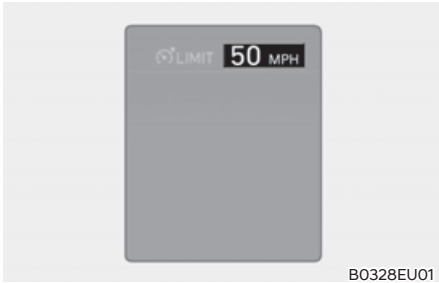

3. The set speed limit will be displayed on the cluster.

If you would like to drive over the preset speed limit, depress the accelerator pedal beyond the pressure point to activate the kickdown function.

The set speed limit will blink and chime will sound until you return the vehicle speed within the speed limit.

### **i** Information

- **When the accelerator pedal is not depressed beyond the pressure point, vehicle speed will maintain within the speed limit.**
- **A clicking sound may be heard from the kickdown function when the accelerator pedal is depressed beyond the pressure point.**

### **Temporarily pausing Manual Speed Limit Assist**

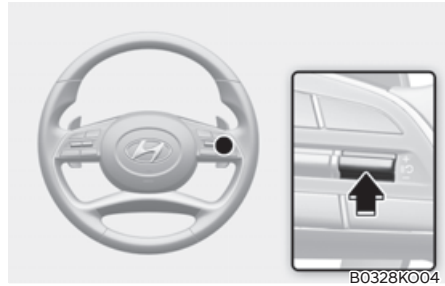

Press the **S** switch to temporarily pause the set speed limit. The set speed limit will turn off but the Speed Limit (LIMIT) indicator will stay on.

### Resuming Manual Speed Limit Assist

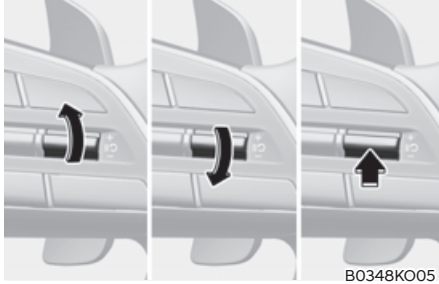

B0348KO05

To resume Manual Speed Limit Assist after the function was paused, operate the +, -, **RES** switch.

If you push the + switch up or – switch down, vehicle speed will be set to the current speed on the cluster.

If you press the **RES** switch, vehicle speed will resume to the preset speed.

### Turning off Manual Speed Limit Assist



B0328KO01

Press the Driving Assist (**DA**) button to turn Manual Speed Limit Assist off. The Speed Limit (**SPEED LIMIT**) indicator will go off.

Always press the Driving Assist (**DA**) button to turn Manual Speed Limit Assist off when not in use.



### WARNING

Take the following precautions when using Manual Speed Limit Assist:

- Always set the vehicle speed to the speed limit in your country.
- Keep Manual Speed Limit Assist off when the function is not in use, to avoid inadvertently setting a speed. Check that the Speed Limit (**SPEED LIMIT**) indicator is off.
- Manual Speed Limit Assist does not substitute for proper and safe driving. It is the responsibility of the driver to always drive safely and be aware of unexpected and sudden situations. Pay attention to the road conditions at all times.

## INTELLIGENT SPEED LIMIT ASSIST (ISLA) (IF EQUIPPED)

Intelligent Speed Limit Assist uses information from the detected road sign and navigation system to inform the driver of the speed limit of the current road. Also, Intelligent Speed Limit Assist helps the driver to maintain within the speed limit of the road.

### CAUTION

- Intelligent Speed Limit Assist may not operate properly if the function is used in other countries.
- If a navigation is applied to your vehicle, the navigation needs to be regularly updated for Intelligent Speed Limit Assist to operate properly.
- The infotainment system may change after software updates. For more information, refer to the user's manual provided in the infotainment system and the quick reference guide.

### Detecting sensor



B0311KO07

 Front view camera

Refer to the picture above for the detailed location of the detecting sensor.

### CAUTION

For more details on the precautions of the front view camera, refer to “Forward Collision-Avoidance Assist (FCA)” section in this chapter.

## Intelligent Speed Limit Assist Settings

### Speed Limit

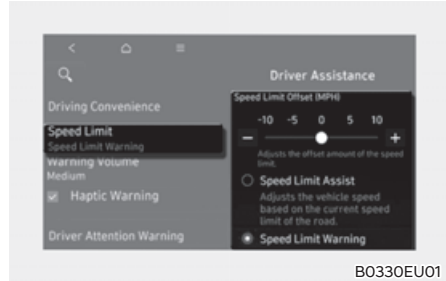

B0330EU01

With the engine on, select or deselect ‘Driver Assistance → Speed Limit’ from the Settings menu to set whether to use each function.

- If ‘Speed Limit Offset’ is selected, the Speed Limit Offset can be adjusted. Speed Limit Warning and Speed Limit Assist will warn the driver and adjust the driving speed when vehicle speed exceeds the speed at which the set Offset is added to speed limit.
- If ‘Speed Limit Assist’ is selected, Intelligent Speed Limit Assist will inform the driver of speed limit and additional road signs. In addition, Intelligent Speed Limit Assist will inform the driver to change set speed of Manual Speed Limit Assist and/or Smart Cruise Control to help the driver stay within the speed limit.
- If ‘Speed Limit Warning’ is selected, Intelligent Speed Limit Assist will inform the driver of speed limit. In addition, Intelligent Speed Limit Assist will warn the driver when the vehicle is driven faster than the speed limit.
- If ‘Off’ is selected, Intelligent Speed Limit Assist will turn off. The  warning light is displayed.

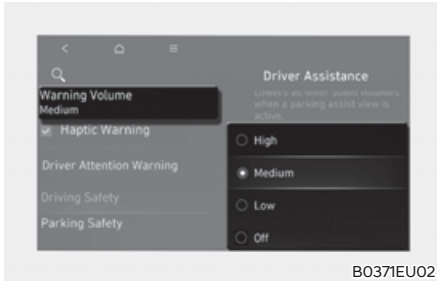

B0371EU02

### Warning Volume

With the vehicle on, select 'Driver Assistance → Warning Volume' or 'Sound → Driver Assistance' from the Settings menu to change the Warning Volume to 'High', 'Medium', 'Low' or 'Off' for Intelligent Speed Limit Assist.

### **i** Information

- If you change the Warning Volume, the Warning Volume of other Driver Assistance systems may change.
- If 'Off' is selected, steering wheel vibration will not turn off.

### **!** WARNING

For your safety, only change the Settings after parking the vehicle at a safe location.

### **i** Information

- Speed Limit Assist function operates based on the Offset setting added to the speed limit. If you want to change the set speed according to the speed limit, adjust the offset to '0'.
- The setting of 'Speed Offset' is not reflected in Navigation-based Smart Cruise Control (NSCC).

## Intelligent Speed Limit Assist Operation

### Warning and control

Intelligent Speed Limit Assist will warn and control the vehicle by 'Displaying speed limit', 'Warning overspeed' and 'Changing set speed'.

### **i** Information

Intelligent Speed Limit Assist warning and control are described based on the Offset adjusted to '0'. For details on Offset setting, refer to the "Intelligent Speed Limit Assist Settings".

### Displaying speed limit



B0331EU01

Speed limit information is displayed on the instrument cluster.

### **i** Information

- If speed limit information of the road cannot be recognized, '---' sign will be displayed. Please refer to "Limitations of Intelligent Speed Limit Assist" if the road signs are difficult to recognize.
- Intelligent Speed Limit Assist provides additional road sign information in addition to speed limit. The additional road sign information provided may vary according to your area.
- The images and colors in the cluster may differ depending on the cluster type or theme selected from the cluster.

### Warning overspeed

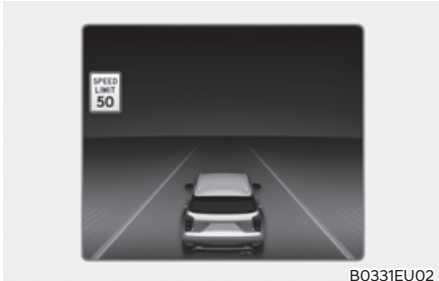

B0331EU02

When driving at a speed higher than the displayed speed limit, the speed limit is displayed in red.

### Changing set speed

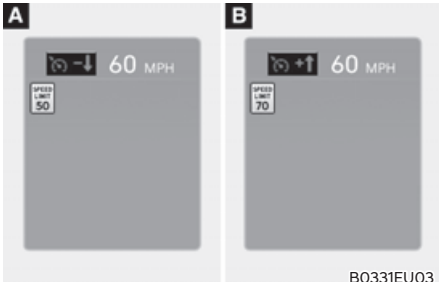

B0331EU03

If the speed limit of the road changes during the operation of Manual Speed Limit Assist or Smart Cruise Control, an arrow in the direction of up or down is displayed to inform the driver that the set speed needs to be changed. At this time, the driver can change the set speed according to the speed limit by using the + or - switch on the steering wheel.

### Set Speed Auto Change (Navigation equipped)



B0331EU04

Manual Speed Limit Assist or Smart Cruise Control assists the vehicle to adjust its speed according to the speed limit. When the cruising speed is set as same as the speed limit, the vehicle automatically adjusts its speed if the speed limit changes. The function operates on the road which has a speed limit of 44 mph (70 km/h) or higher. When the function is active, the cruising speed on the instrument cluster appears in green.

## WARNING

- If you want to drive below the speed limit, adjust the Offset under '0' or use the – switch on the steering wheel to lower the set speed.
- Even after changing the set speed according to the speed limit of the road, the vehicle can still be driven over the speed limit. If necessary, depress the brake pedal to reduce your driving speed.
- If the speed limit of the road is under 20 mph (30 km/h), the set speed change function will not work.
- Intelligent Speed Limit Assist operates using the speed unit in the instrument cluster set by the driver. If the speed unit is set to a unit other than the speed unit used in your country, Intelligent Speed Limit Assist may not operate properly.



## Information

- For more details on Manual Speed Limit Assist operation, refer to “Manual Speed Limit Assist (MSLA)” section in this chapter.
- For more details on Smart Cruise Control operation, refer to “Smart Cruise Control (SCC)” section in this chapter.

## Intelligent Speed Limit Assist Malfunction and Limitations

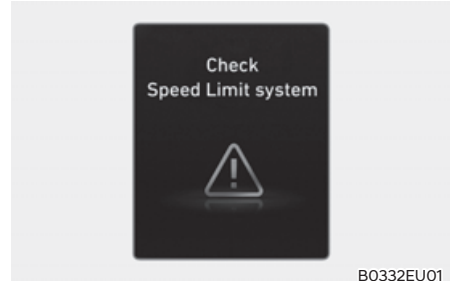
### *Intelligent Speed Limit Assist malfunction*



When Intelligent Speed Limit Assist is not working properly, the 'Check Speed Limit system' warning message will appear on the cluster for several seconds, and the master () warning light and () warning light will illuminate on the cluster. If this occurs, have the vehicle inspected by an authorized HYUNDAI dealer.

### **Intelligent Speed Limit Assist disabled**

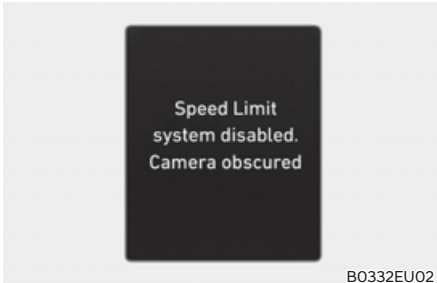

When the front windshield where the front view camera is located is covered with foreign material, such as snow or rain, it can reduce the detecting performance and temporarily limit or disable Intelligent Speed Limit Assist. If this occurs, the 'Speed Limit system disabled. Camera obscured' warning message and (☐) warning light will appear on the cluster.

Intelligent Speed Limit Assist will operate properly when snow, rain or foreign material is removed.

If Intelligent Speed Limit Assist does not operate properly after it is removed, have the vehicle inspected by an authorized HYUNDAI dealer.



### **WARNING**

**Even though the warning message or warning light does not appear on the cluster, Intelligent Speed Limit Assist may not operate properly.**

### **Limitations of Intelligent Speed Limit Assist**

Intelligent Speed Limit Assist may not operate properly, or it may operate unexpectedly under the following circumstances:

- The road sign is contaminated or indistinguishable
  - The road sign is difficult to see due to bad weather, such as rain, snow, fog, etc.
  - The road sign is not clear or damaged
  - The road sign is partially obscured by surrounding objects or shadow
  - A road sign near the road you are driving is detected
- The road signs do not conform to the standard
  - The text or picture on the road sign is different from the standard
  - The road sign is installed between the main line and the exit road or between diverging roads
  - There is no conditional road signs on the road sign located on the exit road
  - A sign is attached to another vehicle
- The distance between the vehicle and the road signs is too far
- The vehicle encounters illuminant road signs
- Intelligent Speed Limit Assist incorrectly recognizes numbers or pictures in the street signs or other signs as the speed limit
- A road sign near the road you are driving is detected
- The other traffic sign or signboards are alongside the road sign
- Multiple signs are installed close together
- The minimum speed limit sign is misrecognized



- The minimum speed limit sign is on the road
- The brightness changes suddenly, for example when entering or exiting a tunnel or passing under a bridge
- Headlights are not used or the brightness of the headlights are weak at night or in the tunnel
- Road signs are difficult to recognize due to the reflection of sunlight, street lights, or oncoming vehicles
- The navigation information or GPS information contain errors.
- The driver does not follow the guide of the navigation.
- The driver is driving on a new road that is not in the navigation system yet.
- The field of view of the front view camera is obstructed by sun glare
- Driving on a road that is sharply curved or continuously curved
- Driving through speed bumps, or driving up and down or left to right on steep inclines
- The vehicle is shaking heavily
- Driving on a newly opened road
- The navigation software is being updated while driving
- The navigation is restarted while driving



## WARNING

- **Intelligent Speed Limit Assist is a supplemental function that helps the driver to comply with the speed limit on the road, and may not display the correct speed limit or control the driving speed properly.**
- **Always set the vehicle speed to the speed limit in your area.**
- **Intelligent Speed Limit Assist may not operate for 15 seconds after the vehicle is started, or the front camera is initialized.**



## Information

**For more details on the limitations of the front view camera, refer to “Forward Collision-Avoidance Assist (FCA)” section in this chapter.**

## DRIVER ATTENTION WARNING (DAW)

### Basic function

Driver Attention Warning can help determine the driver's attention level by analyzing driving pattern and driving time while the vehicle is driven. Driver Attention Warning will recommend a break when the driver's attention level falls below a certain level.

### Leading vehicle departure alert function

Leading Vehicle Departure Alert function will inform the driver when a detected vehicle in front departs.

### Detecting sensor



A: Front view camera

The front view camera is used as a detecting sensor to help detect driving patterns and front vehicle departure while vehicle is being driven.

Refer to the picture above for the detailed location of the detecting sensor.

### CAUTION

- Always keep the front view camera in good condition to maintain optimal performance of Driver Attention Warning.
- For more details on the precautions of the front view camera, refer to “Forward Collision-Avoidance Assist (FCA)” section in this chapter.

## Driver Attention Warning Settings

### Leading Vehicle Departure Alert

With the engine on, select or deselect ‘Driver Assistance → Driver Attention Warning’ from the Settings menu to set whether to use the function.

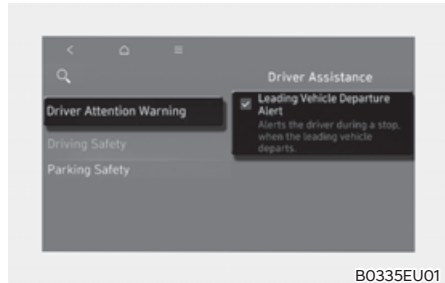

If ‘Leading Vehicle Departure Alert’ is selected, the function will inform the driver when a detected vehicle in front departs from a stop.

## Driver Attention Warning Operation

### Basic function

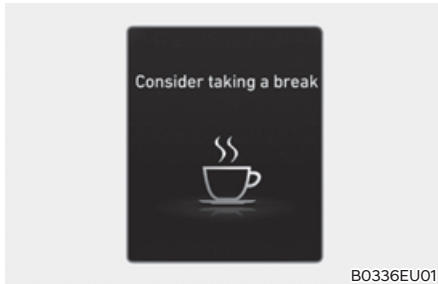

### Taking a break

- The 'Consider taking a break' message will appear on the cluster and an audible warning will sound to suggest that the driver take a break, when the driver's attention level is below 1.
- Driver Attention Warning will not suggest a break when the total driving time is shorter than 4 minutes or 4 minutes has not passed after the last break was suggested.
- The 'Taking a brake' will operate when your vehicle speed is between approximately 0-120 mph (0-200 km/h).



### WARNING

For your safety, change the Settings after parking the vehicle at a safe location.



### CAUTION

- Driver Attention Warning may suggest a break depending on the driver's driving pattern or habits, even if the driver doesn't feel fatigue.
- Driver Attention Warning is a supplemental function and may not be able to determine whether the driver is inattentive.
- A driver who feels fatigued should take a break at a safe location, even though there is no break suggestion by Driver Attention Warning.



### Information

For more details on setting the functions in the infotainment system, refer to "Vehicle Settings" section in chapter 4.

### **Leading Vehicle Departure Alert function**

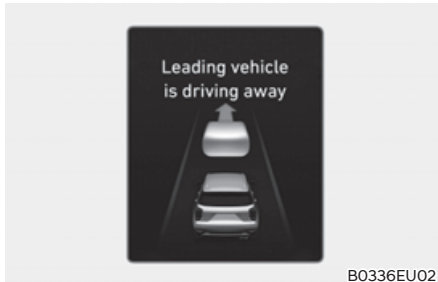

When a detected vehicle in front departs from a stop, Leading Vehicle Departure Alert will inform the driver by displaying the 'Leading vehicle is driving away' message on the cluster and an audible warning will sound.

### **WARNING**

- **If any other system's warning message is displayed or audible warning is generated, Leading Vehicle Departure Alert's warning message may not be displayed and audible warning may not be generated.**
- **The driver has the responsibility to safely drive and control the vehicle.**

### **CAUTION**

- **Leading Vehicle Departure Alert is a supplemental function and may not alert the driver whenever the front vehicle departs from a stop.**
- **Always check the front of the vehicle and road conditions before departure.**

### **Information**

**The images and colors in the instrument cluster may differ depending on the cluster type or theme selected from the settings menu.**

## Driver Attention Warning Malfunction and Limitations

### Driver Attention Warning malfunction

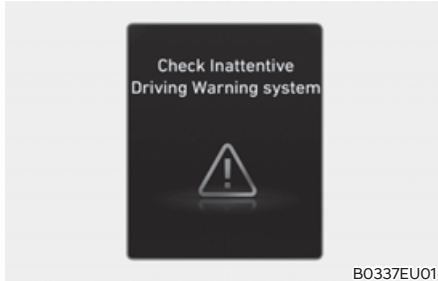

When Driver Attention Warning is not working properly, the 'Check Inattentive Driving Warning system' warning message will appear on the cluster for several seconds, and the master (⚠️) warning light will illuminate on the cluster. If this occurs, have the vehicle inspected by an authorized HYUNDAI dealer.

### Driver Attention Warning disabled

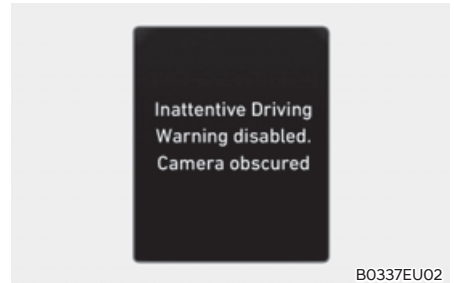

When the front windshield where the front view camera is located is covered with foreign material, such as snow or rain, it can reduce the detecting performance and temporarily limit or disable Driver Attention Warning. If this occurs, the 'Inattentive Driving Warning disabled. Camera obscured' warning message will appear on the instrument cluster. Driver Attention Warning will operate properly when snow, rain or foreign material is removed. If Driver Attention Warning does not operate properly after it is removed, have the vehicle inspected by an authorized HYUNDAI dealer.



### WARNING

- Driver Attention Warning may not properly operate in an area (for example, open terrain) where any objects are not detected right after turning ON the engine.
- If the engine is turned off and restarted while the camera is blocked or malfunctioned, the condition is maintained. Therefore, Driver Attention Warning may not operate properly.

### Limitations of Driver Attention Warning

Driver Attention Warning may not work properly in the following situations:

- The vehicle is driven violently
- The vehicle intentionally crosses over lanes frequently
- The vehicle is controlled by Driver Assistance system, such as Lane Keeping Assist

### Leading Vehicle Departure Alert function

- When the vehicle cuts in

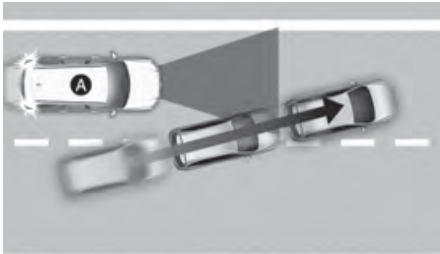

B0337KO02

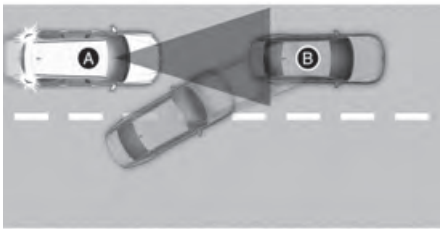

B0337KO03

Ⓐ: Your vehicle, Ⓑ: Front vehicle

If a vehicle cuts in front of your vehicle, Leading Departure Alert may not operate properly.

- When the vehicle ahead sharply steers

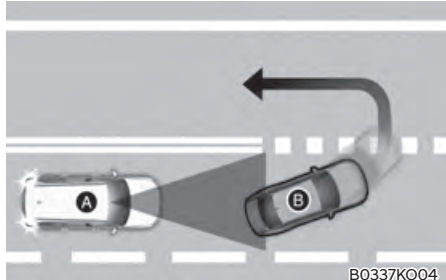

B0337KO04

Ⓐ: Your vehicle, Ⓑ: Front vehicle

If the vehicle in front makes a sharp turn, such as to turn left or right or make a U- turn, etc., Leading Vehicle Departure Alert may not operate properly.

- When the vehicle ahead abruptly departs

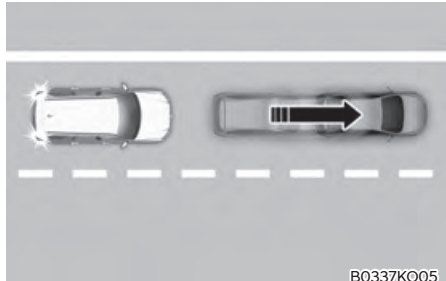

B0337KO05

If the vehicle in front abruptly departs, Leading Vehicle Departure Alert may not operate properly.

- When a pedestrian or bicycle is between you and the vehicle ahead



If there is a pedestrian(s) or bicycle(s) in between you and the vehicle in front, Leading Vehicle Departure Alert may not operate properly.

- When in a parking lot

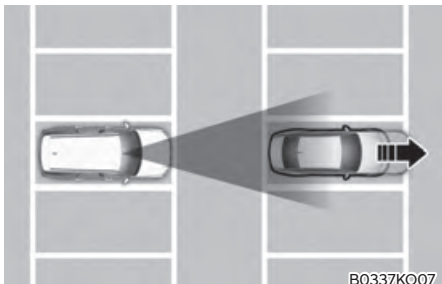

If a vehicle parked in front drives away from you, Leading Vehicle Departure Alert may alert you that the parked vehicle is driving away.

- When driving at a tollgate or intersection, etc.

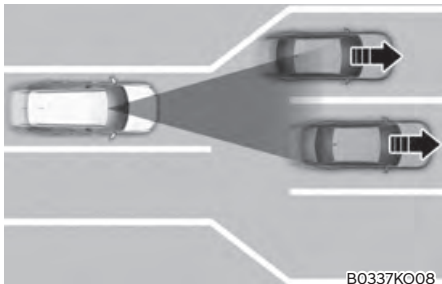

If you pass a tollgate or intersection with lots of vehicles or you drive where lanes are merged or divided frequently, Leading Vehicle Departure Alert may not operate properly.

### **i** Information

For more details on the precautions of the front view camera, refer to “Forward Collision-Avoidance Assist (FCA)” section in this chapter.

## BLIND-SPOT VIEW MONITOR (BVM) (IF EQUIPPED)

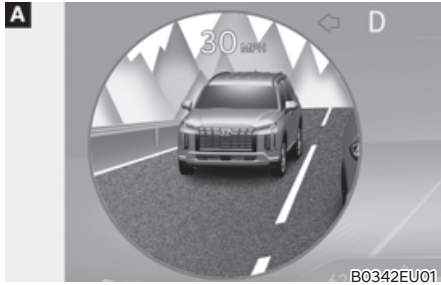

Ⓐ: Left side, Ⓑ: Right side

Blind-Spot View Monitor displays the rear blind spot area of the vehicle in the cluster when the turn signal is turned on to help safely change lanes.

### Detecting sensor

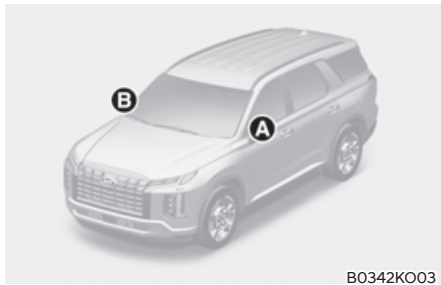

Ⓐ, Ⓑ: Surround-side view camera  
(camera located at bottom of the mirror)

Refer to the picture above for the detailed location of the detecting sensors.

### Blind-Spot View Monitor Settings

#### Setting features

##### Blind-Spot View

With the engine on, select 'Driver Assistance → Driving Safety → Blind Spot View Monitor' from the Settings menu to turn on Blind-Spot View Monitor and deselect to turn off the function.

### Blind-Spot View Monitor Operation

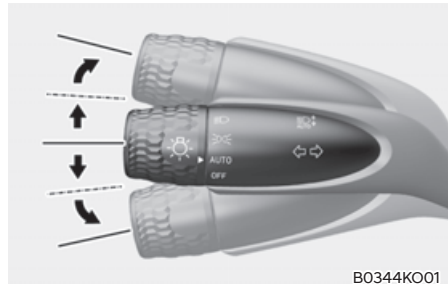

Blind-Spot View Monitor will turn on and off when the turn signal is turned on and off.



### **Operating conditions**

When the left or right side turn signal turns on, the image in that direction is displayed on the instrument cluster.

### **Off conditions**

- When the turn signal turns off, the image on the instrument cluster will turn off.
- When the hazard warning flasher is on, Blind-Spot View Monitor will turn off, regardless of the turn signal status.
- When other important warning is displayed on the instrument cluster, Blind-Spot View Monitor may turn off.

### **Blind-Spot View Monitor Malfunction**

When Blind-Spot View Monitor is not working properly, or the cluster display flickers, or the camera image does not display properly, have the vehicle inspected by an authorized HYUNDAI dealer.



### **WARNING**

- **The image shown on the cluster may differ from the actual distance of the object. Make sure to directly check the vehicle's surroundings for safety.**
- **Always keep the camera lens clean. If the lens is covered with foreign material, it may adversely affect camera performance and Blind-Spot View Monitor may not operate properly.**

## SMART CRUISE CONTROL (SCC) (IF EQUIPPED)

Smart Cruise Control is designed to help detect the vehicle ahead and help maintain the desired speed and minimum distance between the vehicle ahead.

### Overtaking Acceleration Assist

While Smart Cruise Control is operating, if the function judges that the driver is determined to overtake the vehicle in front, acceleration will be assisted.

### Based on Driving Style (if equipped)

Smart Cruise Control will operate based on the driver's driving style, such as inter-vehicle distance, acceleration, reaction speed.

### Detecting sensor



B0311KO07

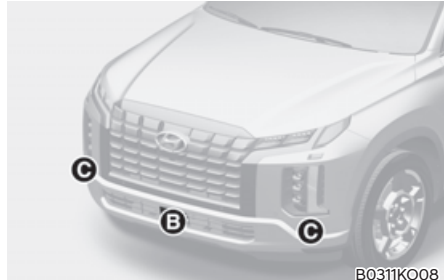

B0311KO08

- Ⓐ: Front view camera, Ⓑ: Front radar  
Ⓒ: Front corner radar (if equipped)

The front view camera and front radar are used as a detecting sensor to help detect vehicles in front.

Refer to the picture above for the detailed location of the detecting sensor.



### CAUTION

**Always keep the front view camera and front radar in good condition to maintain optimal performance of Smart Cruise Control.**

**For more details on the precautions of the front view camera and front radar, refer to “Forward Collision-Avoidance Assist (FCA)” section in this chapter.**

## Smart Cruise Control Settings

### Smart Cruise Control

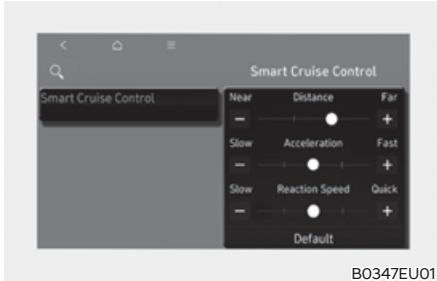

B0347EU01

With the engine on, select 'Driver Assistance → Driving Convenience → Smart Cruise Control' from the setting menu to change Distance, Acceleration, Reaction Speed manually.

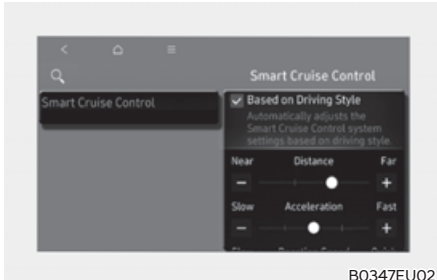

### **Based on Driving Style (if equipped)**



B0347EU02

With the engine on, if 'Driver Assistance → Driving Convenience → Smart Cruise Control → Based on Driving Style' is selected from the Settings menu, Smart Cruise Control will operate based on the driver's driving style, such as vehicle distance, acceleration, reaction speed.

## **i** Information

- While Smart Cruise Control is operating with 'Based on Driving Style' selected, if you press and hold the Vehicle Distance () button, 'Based on Driving Style' will change deactivate. If you press and hold the Vehicle Distance () button again, 'Driving Style Setting' will activate.
- Based on Driving Style setting continuously learns when the driver drives the vehicle.
- When Based on Driving Style is deactivated, the driver's driving style such as vehicle distance, acceleration, reaction speed will maintain in the same stage.
- Even if the steps of the driver's driving style such as vehicle distance, acceleration, reaction speed displayed when the Base on Driving Style is activated or deactivated are the same, the driving style to be controlled may be differently.

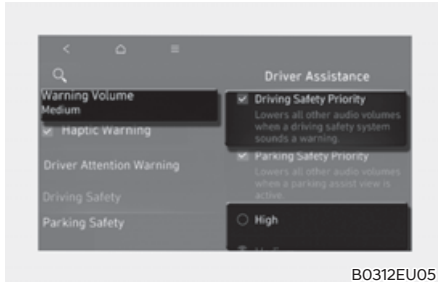

### Warning Volume

With the engine on, select 'Driver Assistance → Warning volume' or 'Sound → Driver Assistance' from the Settings menu to change the Warning Volume 'High', 'Medium', 'Low' or 'Off' for Smart Cruise Control.

If 'Driving Safety Priority' is selected, the vehicle lowers all other audio volumes when the warning sounds for safe driving.

### **i** Information

- If the engine is restarted, Warning Volume will maintain the last setting.
- If 'Off' is selected, steering wheel vibration will not turn off.
- If you change the Warning Volume, the Warning Volume of other Driver Assistance systems may change.

## Smart Cruise Control Operation

### Operating conditions

#### Basic function

Smart Cruise Control operates when the following conditions are satisfied.

- The gear is in D (Drive)
- The driver's door is closed
- EPB (Electronic Parking Brake) is not applied
- Your vehicle speed is within the operating speed range
  - 5~120 mph (10~200 km/h): when there is no vehicle in front
  - 0~120 mph (0~200 km/h): when there is a vehicle in front

- ESC (Electronic Stability Control) or ABS (Anti-Lock Braking System) is on

Smart Cruise Control does not operate in the following conditions.

- The driver's door is opened
- Engine RPM is high
- EPB (Electronic Parking Brake) is applied
- ESC (Electronic Stability Control) or ABS (Anti-Lock Braking System) is controlling the vehicle
- Forward Collision-Avoidance Assist brake control is operating
- Remote Smart Parking Assist brake control is operating (if equipped)
- ISG system is operating

### **i** Information

**When stopped behind another vehicle, the driver can turn on Smart Cruise Control while the brake pedal is depressed.**

### Operating conditions for Acceleration Assist

Overtaking Acceleration Assist operates when the turn signal indicator is turned on to the left while Smart Cruise Control is operating, and the following conditions are satisfied:

- Your vehicle speed is above 40 mph (60 km/h)
- A vehicle is detected in front of your vehicle

Overtaking Acceleration Assist does not operate in the following conditions.

- The hazard warning flasher is on
- Vehicle speed is reduced to maintain distance with the vehicle in front



### WARNING

**When the turn signal indicator is turned on to the left while there is a vehicle ahead, the vehicle may accelerate temporarily. Pay attention to the road conditions at all times.**

### Turning on Smart Cruise Control



- Press the Driving Assist button to turn on Smart Cruise Control. The speed will be set to the current speed on the cluster.
- If there is no vehicle in front of you, the set speed will be maintained, but if there is a vehicle in front of you, the speed may decrease to maintain the distance to the vehicle ahead. If the vehicle ahead accelerates, your vehicle will travel at a steady cruising speed after accelerating to the set speed.



### Information

**If your vehicle speed is between 0~20 mph (0~30 km/h) when you press the Driving Assist button, the Smart Cruise Control speed will be set to 20 mph (30 km/h).**



### Decreasing set speed



B0348KO03

- Push the - switch down and release it immediately. The set speed will decrease by 1 mph (1 km/h) each time the switch is operated in this manner.
- Push the - switch down and hold it while monitoring the set speed on the cluster. The set speed will decrease by 5 mph or 10 km/h each time the switch is operated in this manner.

Release the switch at the speed you want to maintain. You can decrease the set speed to 20 mph (30 km/h).

### Temporarily cancelling Smart Cruise Control

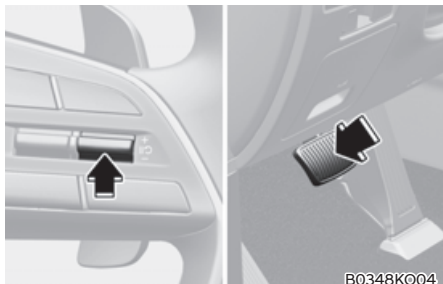

B0348KO04

Press the **||**  switch or depress the brake pedal to temporarily cancel Smart Cruise Control.

### Resuming Smart Cruise Control

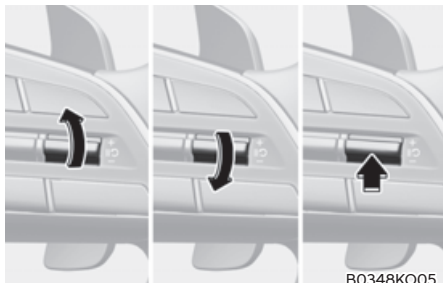



B0348KO05

To resume Smart Cruise Control after the function was canceled, operate the +, - or **||**  switch.

If you push the + switch up or - switch down, vehicle speed will be set to the current speed on the cluster.

If you press the **||**  switch, vehicle speed will resume to the preset speed.

### WARNING

**Check the driving condition before using the **||**  switch. Driving speed may sharply increase or decrease when you press the **||**  switch.**

### Turning off Smart Cruise Control



Press the Driving Assist (  ) button to turn Smart Cruise Control off.

### Information

If your vehicle is equipped with Manual Speed Limit Assist, press and hold the Driving Assist (  ) button to turn off Smart Cruise Control. However Manual Speed Limit Assist will turn on.



### CAUTION

Do not use the switches and buttons at the same time. Smart Cruise Control may not operate properly.

### Display and Control

#### Basic function

You can see the status of the Smart Cruise Control operation in the Driving Assist view on the cluster. Refer to “View Modes” section in chapter 4.

Smart Cruise Control will be displayed as below depending on the status of the function.

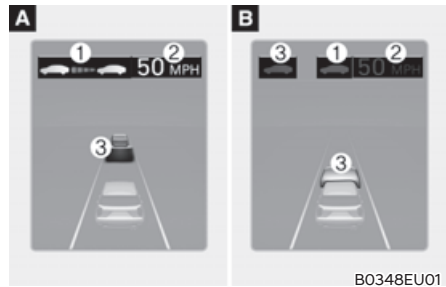

(A): Operating, (B): Temporarily canceled

- When operating
  - (1) Whether there is a vehicle ahead and the selected distance level
  - (2) Set speed
  - (3) Whether there is a vehicle ahead and the target vehicle distance
- When temporarily canceled
  - (1) Your vehicle (shaded)
  - (2) Previous set speed (shaded)
  - (3) Whether there is a vehicle ahead (shaded) (if equipped)



## **i** Information

- The distance of the front vehicle on the cluster is displayed according to the actual distance between your vehicle and the vehicle ahead.
- The target distance may vary according to the vehicle speed and the set distance level. If the vehicle speed is low, even though the vehicle distance have changed, the change of the target vehicle distance may be small.
- The images and colors in the instrument cluster may differ depending on the cluster type or theme selected from the settings menu.

### Accelerating temporarily

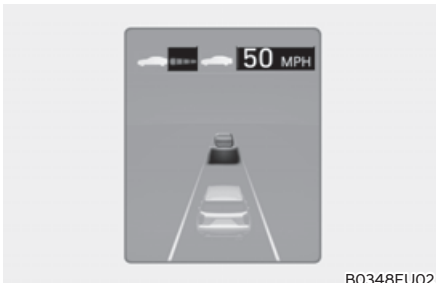

B0348EU02

If you want to speed up temporarily without altering the set speed while Smart Cruise Control is operating, depress the accelerator pedal. While the accelerator pedal is depressed, the set speed, distance level and target distance will blink on the cluster.

However, if the accelerator pedal is depressed insufficiently, the vehicle may decelerate.

## **!** WARNING

**Be careful when accelerating temporarily, because the speed and distance is not controlled automatically even if there is a vehicle in front of you.**

### Based on Driving Style operation

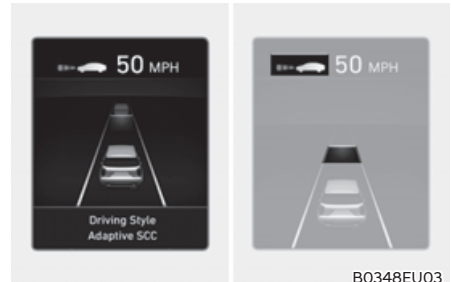

B0348EU03

When Based on Driving Style is operating, 'Driving Style Adaptive SCC' message will appear on the cluster for 2 seconds, and the distance level and target distance will be displayed based on the driving style.

### Temporarily cancelling Smart Cruise Control

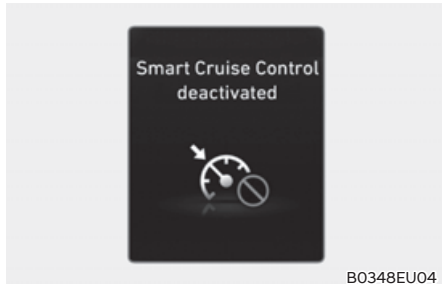

B0348EU04

Smart Cruise Control will be temporarily canceled automatically when:

- The vehicle speed is above 130 mph (210 km/h)
- The vehicle is stopped for a certain period of time
- The accelerator pedal is continuously depressed for a certain period of time
- The conditions for the Smart Cruise Control to operate is not satisfied

If Smart Cruise Control is temporarily canceled automatically, the 'Smart Cruise Control deactivated' warning message will appear on the cluster, and an audible warning will sound to warn the driver.

#### Information

**If Smart Cruise Control is temporarily canceled while the vehicle is at a standstill with the function activated, EPB (Electronic Parking Brake) maybe applied.**

#### WARNING

**When Smart Cruise Control is temporarily canceled, distance with the front vehicle will not be maintained. Always have your eyes on the road while driving, and if necessary, depress the brake pedal to reduce your driving speed in order to maintain a safe distance.**

### Smart Cruise Control conditions not satisfied

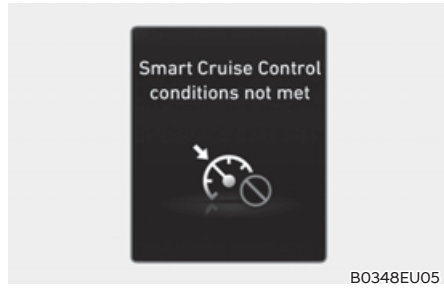

B0348EU05

If the Driving Assist button, + switch, - switch or  switch is operated when Smart Cruise Control operating conditions are not satisfied, the 'Smart Cruise Control conditions not met' will appear on the cluster, and an audible warning will sound.

### In traffic situation

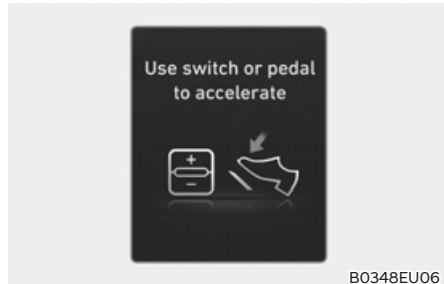

B0348EU06

In traffic, your vehicle will stop if the vehicle ahead of you stops. Also, if the vehicle ahead of you starts moving, your vehicle will start as well. In addition, after the vehicle has stopped and a certain time have passed, the 'Use switch or pedal to accelerate' message will appear on the cluster. Depress the accelerator pedal or operate the + switch, - switch or  switch to start driving.

## Warning road conditions ahead



In the following situation, the 'Watch for surrounding vehicles' warning message will appear on the cluster, and an audible warning will sound to warn the driver of road conditions ahead.

- The vehicle in front disappears when Smart Cruise Control is maintaining the distance with the vehicle ahead while driving below a certain speed.



### WARNING

**Always pay attention to vehicles or objects that may suddenly appear in front of you, and if necessary, depress the brake pedal to reduce your driving speed in order to maintain a safe distance.**

## Collision Warning



While Smart Cruise Control is operating, when the collision risk with the vehicle ahead is high, the 'Collision Warning' warning message will appear on the cluster, and an audible warning will sound to warn the driver. Always have your eyes on the road while driving, and if necessary, depress the brake pedal to reduce your driving speed in order to maintain a safe distance.



### WARNING

**In the following situations, Smart Cruise Control may not warn the driver of a collision.**

- The distance from the front vehicle is near, or the vehicle speed of the front vehicle is faster or similar with your vehicle
- The speed of the front vehicle is very slow or is at a standstill
- The accelerator pedal is depressed right after Smart Cruise Control is turned on



## WARNING

Take the following precautions when using Smart Cruise Control:

- Smart Cruise Control does not substitute for proper and safe driving. It is the responsibility of the driver to always check the speed and distance to the vehicle ahead.
- Smart Cruise Control may not recognize unexpected and sudden situations or complex driving situations, so always pay attention to driving conditions and control your vehicle speed.
- Keep Smart Cruise Control off when the function is not in use to avoid inadvertently setting a speed.
- Do not open the door or leave the vehicle when Smart Cruise Control is operating, even if the vehicle is stopped.
- Always be aware of the selected speed and headway distance.
- Keep a safe distance according to road conditions and vehicle speed. If the headway distance is too close during high-speed driving, a serious collision may result.
- When maintaining distance with the vehicle ahead, if the front vehicle disappears, Smart Cruise Control may suddenly accelerate to the set speed. Always be aware of unexpected and sudden situations from occurring.
- Vehicle speed may decrease on an upward slope and increase on a downward slope.
- Always be aware of situations such as when a vehicle cuts in suddenly.
- When you are towing a trailer or another vehicle, turn off Smart Cruise Control for safety reasons.
- Turn off Smart Cruise Control when your vehicle is being towed.
- Smart Cruise Control may not operate properly if interfered by strong electromagnetic waves.
- Smart Cruise Control may not detect an obstacle in front and lead to a collision. Always look ahead cautiously to prevent unexpected and sudden situations from occurring.
- Vehicles moving in front of you with a frequent lane change may cause a delay in Smart Cruise Control reaction or may cause Smart Cruise Control to react to a vehicle actually in an adjacent lane. Always drive cautiously to prevent unexpected and sudden situations from occurring.
- Always be aware of the surroundings and drive safely, even though a warning message does not appear or an audible warning does not sound.
- If any other system's warning message is displayed or warning sound is generated, Smart Cruise Control warning message may not be displayed and warning sound may not be generated.
- You may not hear the warning sound of Forward Collision-Avoidance Assist if the surrounding is noisy.
- The vehicle manufacturer is not responsible for any traffic violation or accidents caused by the driver.
- Always set the vehicle speed under the speed limit in your area.
- Vehicle distance, acceleration and reaction speed may change if the driver's driving style changes.



## CAUTION

- The vehicle must be driven sufficiently to reflect the actual driving style of the driver, such as inter-vehicle distance, acceleration and reaction speed.
- Based on Driving style does not reflect whether the driver has changed when determining the driver's driving style.
- If you are driving in special conditions, such as snow, rain, fog or steep slopes, the vehicle may not be driven according to the driver's driving style.



## Information

- Smart Cruise Control may not operate for 15 seconds after the vehicle is started or the front view camera or front radar is initialized.
- You may hear a sound when the brake is controlled by Smart Cruise Control.
- Based on Driving Style may not reflect the driver's driving style or driving conditions that affects driving safety.
- Based on Driving Style does not reflect any other driving style other than inter-vehicle distance, acceleration and reaction speed.

## Smart Cruise Control Malfunction and Limitations

### Smart Cruise Control malfunction

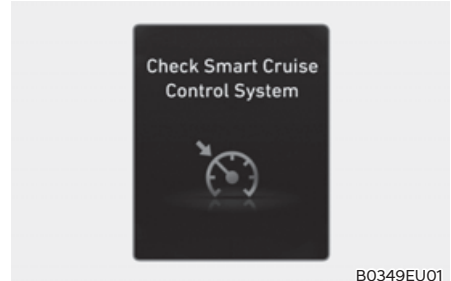

B0349EU01

When Smart Cruise Control is not working properly, the 'Check Smart Cruise Control system' warning message will appear, and the  warning light will illuminate on the cluster. Have the vehicle inspected by an authorized HYUNDAI dealer.

### Smart Cruise Control disabled

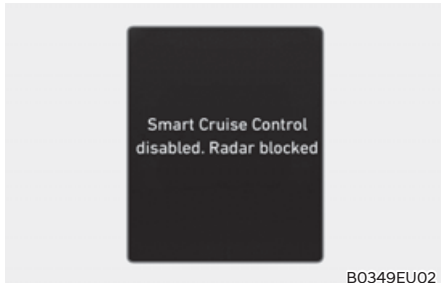

When the front radar cover or sensor is covered with snow, rain, or foreign material, it can reduce the detecting performance and temporarily limit or disable Smart Cruise Control.

If this occurs the 'Smart Cruise Control disabled. Radar blocked' warning message will appear for a certain period of time on the cluster.

Smart Cruise Control will operate properly when snow, rain or foreign material is removed.



#### WARNING

**Even though the warning message does not appear on the cluster, Smart Cruise Control may not properly operate.**



#### CAUTION

**Smart Cruise Control may not properly operate in an area (for example, open terrain), where there is nothing to detect after turning ON the engine.**

### Limitations of Smart Cruise Control

Smart Cruise Control may not operate properly, or it may operate unexpectedly under the following circumstances:

- The detecting sensor or the surroundings are contaminated or damaged
- Washer fluid is continuously sprayed, or the wiper is on
- The camera lens is contaminated due to tinted, filmed or coated windshield, damaged glass, or sticky foreign material (sticker, bug, etc.) on the glass
- Moisture is not removed or frozen on the windshield
- The field of view of the front view camera is obstructed by sun glare
- Street light or light from an oncoming vehicle is reflected on the wet road surface, such as a puddle on the road
- The temperature around the front view camera is high or low
- An object is placed on the dashboard
- The surrounding is very bright
- The surrounding is very dark, such as in a tunnel, etc.
- The brightness changes suddenly, for example when entering or exiting a tunnel
- The brightness outside is low, and the headlights are not on or are not bright
- Driving in heavy rain or snow, or thick fog
- Driving through steam, smoke or shadow

- Only part of the vehicle is detected
- The vehicle in front has no tail lights, tail lights are located unusually, etc.
- The brightness outside is low, and the tail lamps are not on or are not bright
- The rear of the front vehicle is small or does not look normal (for example, tilted, overturned, etc.)
- The front vehicle's ground clearance is low or high
- A vehicle suddenly cuts in front
- Your vehicle is being towed
- Driving through a tunnel or iron bridge
- Driving near areas containing metal substances, such as a construction zone, railroad, etc.
- An object reflecting off the front radar such as a guardrail, nearby vehicle, etc.
- The bumper around the front radar is impacted, damaged or the front radar is out of position
- The temperature around the front radar is high or low
- Driving in vast areas where there are few vehicles or structures (for example, desert, meadow, suburb, etc.)
- The vehicle in front is made of material that does not reflect on the front radar
- Driving near a highway (or motorway) interchange or tollgate
- Driving on a slippery surface due to snow, water puddle, ice, etc.
- Driving on a curved road
- The vehicle in front is detected late
- The vehicle in front is suddenly blocked by an obstacle
- The vehicle in front suddenly changes lane or suddenly reduces speed
- The vehicle in front is bent out of shape
- The front vehicle's speed is fast or slow
- With a vehicle in front, your vehicle changes lane at low speed
- The vehicle in front is covered with snow
- Unstable driving
- You are on a roundabout and the vehicle in front is not detected
- You are continuously driving in a circle
- Driving in a parking lot
- Driving through a construction area, unpaved road, partial paved road, uneven road, speed bumps, etc.
- Driving on an incline road, curved road, etc.
- Driving through a roadside with trees or streetlights
- The adverse road conditions cause excessive vehicle vibrations while driving
- Your vehicle height is low or high due to heavy loads, abnormal tire pressure, etc.
- Driving through a narrow road where trees or grass are overgrown
- There is interference by electromagnetic waves, such as driving in an area with strong radio waves or electrical noise

- Driving on a curved road

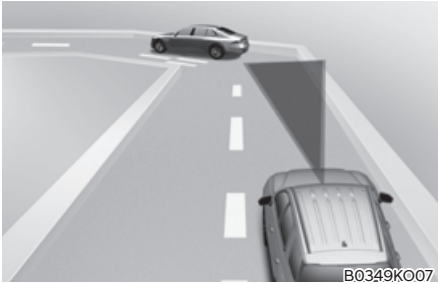

On curves, Smart Cruise Control may not detect a vehicle in the same lane, and may accelerate to the set speed. Also, vehicle speed may rapidly decrease when the vehicle ahead is detected suddenly.

Select the appropriate set speed on curves and apply the brake pedal or accelerator pedal according to the road and driving conditions ahead.

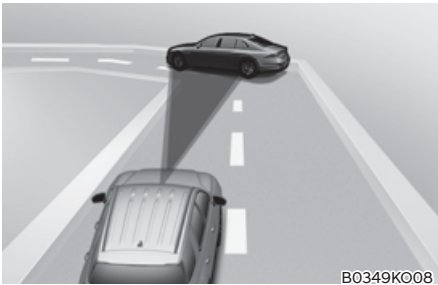

Your vehicle speed can be reduced due to a vehicle in the adjacent lane.

Apply the accelerator pedal and select the appropriate set speed. Check to be sure that the road conditions permit safe operation of the Smart Cruise Control.

- Driving on an inclined road



During uphill or downhill driving, the Smart Cruise Control may not detect a moving vehicle in your lane, and cause your vehicle to accelerate to the set speed. Also, vehicle speed will rapidly decrease when the vehicle ahead is detected suddenly.

Select the appropriate set speed on inclines and apply the brake pedal or accelerator pedal according to the road and driving conditions ahead.



- Changing lanes



Ⓐ: Your vehicle, Ⓑ: Lane changing vehicle

When a vehicle moves into your lane from an adjacent lane, it cannot be detected by the sensor until it is in the sensor's detection range. Smart Cruise Control may not immediately detect the vehicle when the vehicle changes lanes abruptly. In this case, you must maintain a safe braking distance, and if necessary, depress the brake pedal to reduce your driving speed in order to maintain a safe distance.

- Situations when detecting are limited

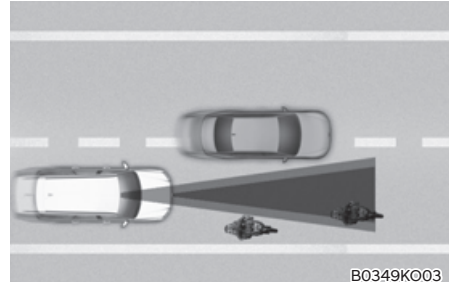

B0349KO03



B0314KO16

In the following cases, some vehicles, pedestrians or animals in your lane cannot be detected by the sensor:

- Vehicles offset to one side
- Slow-moving vehicles or sudden decelerating vehicles
- Vehicles with higher ground clearance or vehicles carrying loads that stick out of the back of the vehicle
- Vehicles that has the front lifted due to heavy loads
- Vehicles within approximately 6 ft. (2m) from your vehicle
- Oncoming vehicles
- Stopped vehicles
- Vehicles with small rear profile, such as trailers
- Narrow vehicles, such as motorcycles or bicycles
- Special vehicles
- Animals and pedestrians

Adjust your vehicle speed by depressing the brake pedal according to the road and driving conditions ahead.

In the following cases, the vehicle in front cannot be detected by the sensor:

- You are steering your vehicle
- Driving on narrow or sharply curved roads

Adjust your vehicle speed by depressing the brake pedal according to the road and driving conditions ahead.

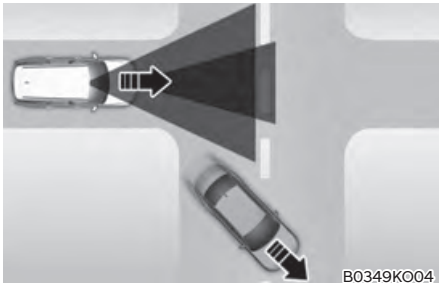

- When a vehicle ahead disappears at an intersection, your vehicle may accelerate.

Always pay attention to road and driving conditions while driving.

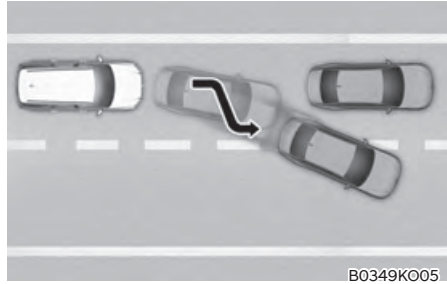

- When a vehicle in front of you merges out of the lane, Smart Cruise Control may not immediately detect the new vehicle that is now in front of you. Always pay attention to road and driving conditions while driving.

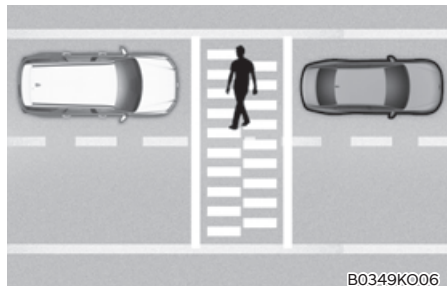

- Always look out for pedestrians when your vehicle is maintaining a distance with the vehicle ahead.

**i** Information

This device complies with Part 15 of the FCC rules.

Operation is subject to the following three conditions:

1. This device may not cause harmful interference, and
2. This device must accept any interference received, including interference that may cause undesired operation.
3. Changes or modifications not expressly approved by the party responsible for compliance could void the user's authority to operate the device.

**i** Information

Radio frequency radiation exposure information:

This equipment complies with FCC radiation exposure limits set forth for an uncontrolled environment.

This equipment should be installed and operated with minimum distance of 8 in. (20 cm) between the radiator (antenna) and your body.

This transmitter must not be co-located or operating in conjunction with any other antenna or transmitter.

## NAVIGATION-BASED SMART CRUISE CONTROL (NSCC) (IF EQUIPPED)

Navigation-based Smart Cruise Control helps drive at a certain speed according to the road conditions when driving on highways (or motorways) by using road information from the navigation system while Smart Cruise Control is operating.

### **i** Information

- **Navigation-based Smart Cruise Control is available only on controlled access road of certain highways.**
  - \* **Controlled access road indicates roads with limited entrances and exits that allow uninterrupted high speed traffic flow. Only passenger cars and motorcycles are allowed on controlled access roads.**
- **Additional highways may be expanded by future navigation updates.**

Available highway (Controlled access road)	
USA	Select Interstate Highway and U.S. (Federal) and State Highways
Canada	Select Provincial and Territorial Highways

### **i** Information

Navigation-based Smart Cruise Control operates on main roads of highways (or motorways), and does not operate on interchanges or junctions.

#### Highway Curve Zone Auto Slowdown

If vehicle speed is high, Highway Curve Zone Auto Slowdown function will temporarily decelerate your vehicle or limit acceleration to help you drive safely on a curve based on the curve information from the navigation.

## Navigation-Based Smart Cruise Control Settings

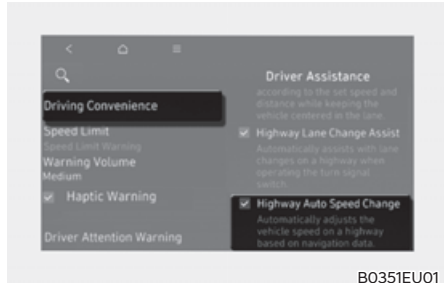

### Highway Auto Speed Change

With the engine on, select 'Driver Assistance → Driving Convenience → Highway Auto Speed Change' from the Settings menu to turn on Navigation-based Smart Cruise Control and deselect to turn off the function.

### **i** Information

**When there is a problem with Navigation-based Smart Cruise Control, the function cannot be set from the Settings menu.**

## Navigation-Based Smart Cruise Control Operation

### Operating conditions

Navigation-based Smart Cruise Control is ready to operate if all of the following conditions are satisfied:

- Smart Cruise Control is operating
- Driving on main roads of highways

### **i** Information

For more details on how to operate Smart Cruise Control, refer to “Smart Cruise Control (SCC)” section in this chapter.

### Navigation-based Smart Cruise Control display and control

When Navigation-based Smart Cruise Control operates, it will be displayed on the cluster as follows:



B0352EU02

#### Navigation-based Smart Cruise Control standby

If the operating conditions are satisfied, the white **NAV** indicator will illuminate.

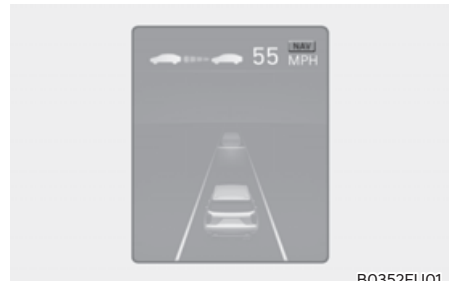

B0352EU01

#### Navigation-based Smart Cruise Control operating

If temporary deceleration is required in the standby state and Navigation-based Smart Cruise Control is operating, the green **NAV** symbol will illuminate on the cluster.

If the Highway Set Speed Auto Change function operates, the **NAV** symbol and set speed will illuminate in green on the cluster, and an audible warning will sound.

 **WARNING**



**'Drive carefully' warning message will appear in the following circumstances:**

- Navigation-based Smart Cruise Control is not able to slow down your vehicle to a safe speed

 **Information**

- Highway Curve Zone Auto Slowdown function uses the same **NAV** symbol.
- The images and colors in the instrument cluster may differ depending on the cluster type or theme selected from the settings menu.

**Highway Curve Zone Auto Slowdown**

- Depending on the curve ahead on the highway (or motorway), the vehicle will decelerate, and after passing the curve, the vehicle will accelerate to Smart Cruise Control set speed.
- Vehicle deceleration time may differ depending on the vehicle speed and the degree of the curve on the road. The higher the driving speed, deceleration will start faster.

## Limitations of Navigation-Based Smart Cruise Control

Navigation-based Smart Cruise Control may not operate properly under the following circumstances:

- The navigation is not working properly
- Map information is not transmitted due to infotainment system's abnormal operation
- Speed limit and road information in the navigation is not updated
- The map information and the actual road is different because of real-time GPS data or map information error
- The navigation searches for a route while driving
- GPS signals are blocked in areas such as a tunnel
- A road that divides into two or more roads and joins again
- The driver goes off course the route set in the navigation
- The route to the destination is changed or canceled by resetting the navigation
- The vehicle enters a service station or rest area
- Android Auto or Car Play is operating
- The navigation cannot detect the current vehicle position (for example, elevated roads including overpass adjacent to general roads or nearby roads exist in a parallel way)
- The navigation is being updated while driving
- The navigation is being restarted while driving
- The speed limit of some sections changes according to the road situations
- Driving on a road under construction
- Driving on a road that is controlled
- There is bad weather, such as heavy rain, heavy snow, etc.
- Driving on a road that is sharply curved

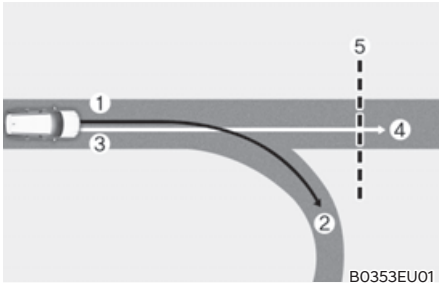

①: Set route, ②: Branch line, ③: Driving route,  
④: Main road, ⑤: Curved road section

- When there is a difference between the navigation set route (branch line) and the driving route (main road), Highway Curve Zone Auto Slowdown function may not operate until the driving route is recognized as the main road.
- When the vehicle's driving route is recognized as the main road by maintaining the main road instead of the navigation set route, Highway Curve Zone Auto Slowdown function will operate. Depending on the distance to the curve and the current vehicle speed, vehicle deceleration may not be sufficient or may decelerate rapidly.

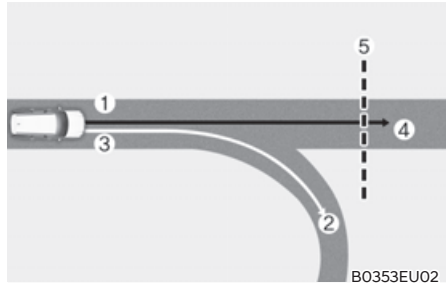

①: Set route, ②: Branch line, ③: Driving route,  
④: Main road, ⑤: Curved road section

- When there is a difference between the navigation route (main road) and the driving route (branch line), Highway Curve Zone Auto Slowdown function will operate based on the curve information on the main road.
- When it is judged that you are driving out of the route by entering the highway interchange or junction, Highway Curve Zone Auto Slowdown function will not operate.



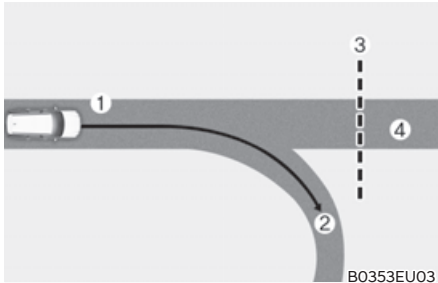

①: Driving route, ②: Branch line,  
③: Curved road section, ④: Main road

- If there is no destination set on the navigation, Highway Curve Zone Auto Slowdown function will operate based on the curve information on the main road.
- Even if you depart from the main road, Highway Curve Zone Auto Slowdown function may temporarily operate due to navigation information of the highway curve section.

## WARNING

- Navigation-based Smart Cruise Control is not a substitute for safe driving practices, but a convenience function. Always have your eyes on the road, and it is the responsibility of the driver to avoid violating traffic laws.
- The navigation's speed limit information may differ from the actual speed limit information on the road. It is the driver's responsibility to check the speed limit on the actual driving road or lane.
- Navigation-based Smart Cruise Control will automatically be canceled when you leave the highway (or motorway) main road. Always pay attention to road and driving conditions while driving.
- Navigation-based Smart Cruise Control may not operate due to the existence of leading vehicles and the driving conditions of the vehicle. Always pay attention to road and driving conditions while driving.
- When you are towing a trailer or another vehicle, turn off Navigation-based Smart Cruise Control for safety reasons.
- After you pass through a tollgate on a highway (or motorway), Navigation-based Smart Cruise Control will operate based on the first lane. If you enter one of the other lanes, Navigation-based Smart Cruise Control might not operate properly.
- The vehicle will accelerate if the driver depresses the accelerator pedal while Navigation-based Smart Cruise Control is operating, and the function will not decelerate the vehicle. However, if the accelerator pedal is depressed insufficiently, the vehicle may decelerate.

- If the driver accelerates and releases the accelerator pedal while Navigation-based Smart Cruise Control is operating, the vehicle may not decelerate sufficiently or may rapidly decelerate to a safe speed.
- If the curve is too large or too small, Navigation-based Smart Cruise Control may not operate.

### **i** Information

- A time gap could occur between the navigation's guidance and when Navigation-based Smart Cruise Control operation starts and ends.
- The speed information on the cluster and navigation may differ.
- Even if you are driving at a speed lower than Smart Cruise Control set speed, acceleration may be limited by the curve sections ahead.
- If Navigation-based Smart Cruise Control is operating while leaving the main road to enter an interchange, junction, rest area, etc., the function may operate for a certain period of time.
- Deceleration by Navigation-based Smart Cruise Control may feel it is not sufficient due to road conditions such as uneven road surfaces, narrow lanes, etc.

### **i** Information

This device complies with Part 15 of the FCC rules.

Operation is subject to the following three conditions:

1. This device may not cause harmful interference, and
2. This device must accept any interference received, including interference that may cause undesired operation.
3. Changes or modifications not expressly approved by the party responsible for compliance could void the user's authority to operate the device.

### **i** Information

Radio frequency radiation exposure information:

This equipment complies with FCC radiation exposure limits set forth for an uncontrolled environment.

This equipment should be installed and operated with minimum distance of 8 in. (20 cm) between the radiator (antenna) and your body.

This transmitter must not be co-located or operating in conjunction with any other antenna or transmitter.

## LANE FOLLOWING ASSIST (LFA)

Lane Following Assist is designed to help detect lane markings and/or vehicles on the road, and assists the driver's steering to help center the vehicle in the lane.

### Detecting sensor



B0311K007

Ⓐ: Front view camera

The front view camera is used as a detecting sensor to detect lane markings and front vehicles.

Refer to the picture above for the detailed location of the detecting sensor.



### CAUTION

For more details on the precautions of the front view camera, refer to “Forward Collision-Avoidance Assist (FCA)” section in this chapter.

## Lane Following Assist Settings Warning Volume

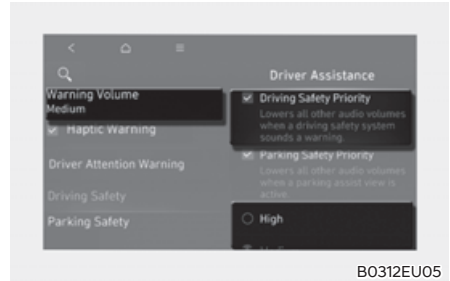

B0312EU05

With the engine on, select ‘Driver Assistance → Warning volume’ or ‘Sound → Driver Assistance’ from the Settings menu to change the Warning Volume to ‘High’, ‘Medium’, ‘Low’ or ‘Off’ for Hands-off warning.

If ‘Driving Safety Priority’ is selected, the vehicle lowers all other audio volumes when the warning sounds for safe driving.

### Information

- If ‘Off’ is selected, the Hands-off Warning Volume will not turn off, but the volume will sound as ‘Low’.
- If you change the Warning Volume, the Warning Volume of other Driver Assistance systems may change.

## Lane Following Assist Operation

### Turning Lane Following Assist On/ Off



With the engine on, shortly press the Lane Driving Assist button located on the steering wheel to turn on Lane Following Assist. The grey or green  indicator light will illuminate on the cluster.

Press the button again to turn off the function.

## Lane Following Assist



If the vehicle ahead and/or both lane markings are detected and your vehicle speed is below 120 mph (200 km/h), the green  indicator light illuminates on the cluster, and Lane Following Assist helps center the vehicle in the lane by assisting the steering wheel.

### CAUTION

**When the steering wheel is not assisted, the white  indicator light blinks and changes to grey.**

## Hands-off warning



B0317EU01

If the driver takes their hands off the steering wheel for several seconds, the 'Keep hands on the steering wheel' warning message will appear and an audible warning will sound in stages.

First stage : Warning message

Second stage : Warning message (red steering wheel) and audible warning



B0356EU01

If the driver still does not have their hands on the steering wheel after the hands-off warning, the 'Lane Following Assist deactivated' warning message will appear and Lane Following Assist will be automatically canceled.

## WARNING

- The steering wheel may not be assisted if the steering wheel is held very tight or the steering wheel is steered over a certain degree.
- Lane Following Assist does not operate at all times. It is the responsibility of the driver to safely steer the vehicle and to maintain the vehicle in its lane.
- The hands-off warning message may appear late depending on road conditions. Always have your hands on the steering wheel while driving.
- If the steering wheel is held very lightly the hands-off warning message may appear because Lane Following Assist may not recognize that the driver has their hands on the steering wheel.
- If you attach objects to the steering wheel, the hands-off warning may not work properly.

**i** Information

- For more details on instrument cluster settings, refer to “LCD display control” section in chapter 4.
- When both lane markings are detected, the lane lines on the cluster will change from grey to white.

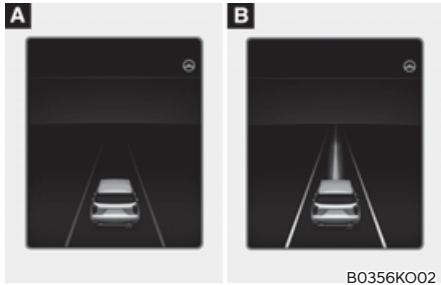

B0356KO02

Ⓐ: Lane undetected, Ⓑ: Lane detected

- The images and colors in the cluster may differ depending on the cluster type or theme selected from the cluster.
- If lane markings are not detected, steering wheel control by Lane Following Assist can be limited depending on whether a vehicle is in front or the driving conditions of the vehicle.
- Even though the steering is assisted by Lane Following Assist, the driver may control the steering wheel.
- The steering wheel may feel heavier or lighter when the steering wheel is assisted by Lane Following Assist than when it is not.

**Lane Following Assist Malfunction and Limitations**

**Lane Following Assist malfunction**

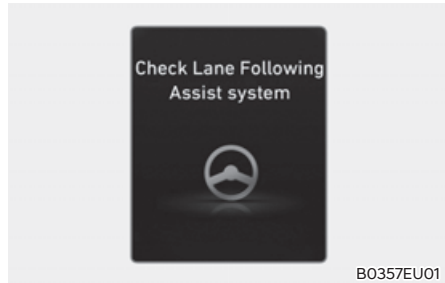

B0357EU01

When Lane Following Assist is not working properly, the ‘Check Lane Following Assist system’ warning message will appear on the cluster for several seconds, and the master (⚠) warning light illuminates on the cluster. If this occur, have the vehicle inspected by an authorized HYUNDAI dealer.

**Limitations of Lane Following Assist**

For more details on Lane Following Assist limitations, refer to “Lane Keeping Assist (LKA)” section in this chapter.

**i** Information

For more details on Lane Following Assist precautions, refer to “Lane Keeping Assist (LKA)” section in this chapter.

## HIGHWAY DRIVING ASSIST (HDA) (IF EQUIPPED)

### Basic function

Highway Driving Assist is designed to do the following while driving on the highway:

- Help detect vehicles ahead
- Help detect lanes ahead
- Help maintain distance from the vehicle ahead
- Help maintain set speed
- Help center the vehicle in the lane

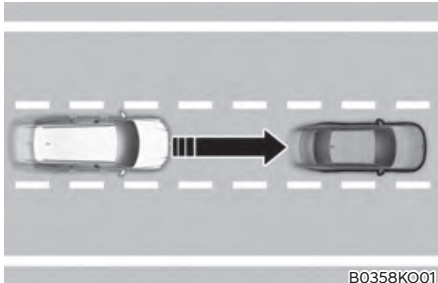

B0358KO01

### Highway Lane Change Assist (if equipped)

Highway Lane Change Assist function helps change lanes to the direction the driver slightly moves the turn signal switch if the function judges that lane change is possible.

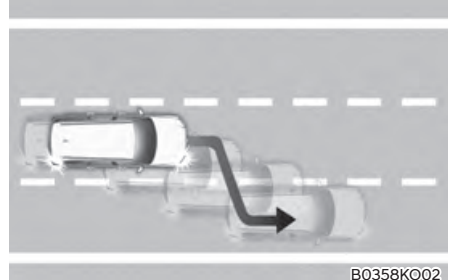

B0358KO02

### **i** Information

- **Highway Driving Assist is available only on controlled access road of certain highways.**
  - \* **Controlled access road indicates roads with limited entrances and exits that allow uninterrupted high speed traffic flow. Only passenger cars and motorcycles are allowed on controlled access roads.**
- **Additional highways may be expanded by future navigation updates.**

Available highway (Controlled access road)	
USA	Select Interstate Highway and U.S. (Federal) and State Highways
Canada	Select Provincial and Territorial Highways

### **i** Information

**Highway Driving Assist operates on main roads of highways, and does not operate on interchanges or junctions.**

### Detecting sensor (if equipped)

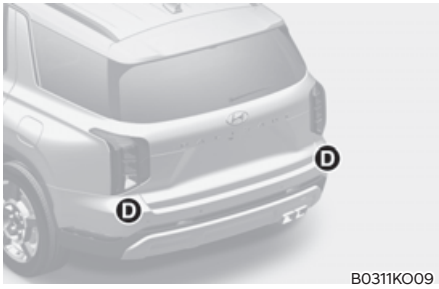
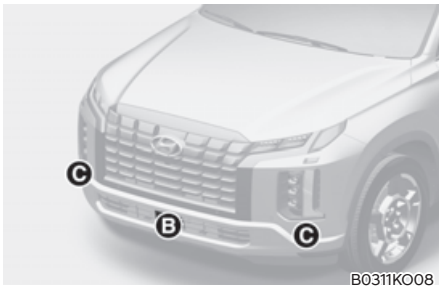

- (A): Front view camera, (B): Front radar,
- (C): Front corner radar (if equipped),
- (D): Rear corner radar (if equipped)

Refer to the picture above for the detailed location of the detecting sensors.

### CAUTION

For more details on the precautions of the detecting sensors, refer to “Forward Collision-Avoidance Assist (FCA)” section in this chapter.

### Highway Driving Assist Settings

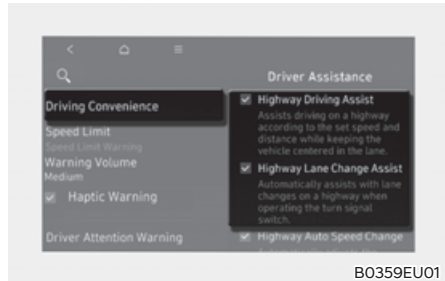

With the engine on, select or deselect ‘Driver Assistance → Driving Convenience’ from the Settings menu to set whether use each function.

### Basic function

If ‘Highway Driving Assist’ is selected, it helps maintain distance from the vehicle ahead, maintain the set speed, and helps center the vehicle in the lane.



### Highway Lane Change Assist (if equipped)

If 'Highway Lane Change Assist' is selected, it helps the driver change lanes.

#### **i** Information

- When 'Highway Driving Assist' is deselected, the setting for 'Highway Lane Change Assist' cannot be changed.
- If there is a problem with the functions, the settings cannot be changed. Have the vehicle inspected by an authorized HYUNDAI dealer.
- If the engine is restarted, the functions will maintain the last setting.

#### **!** WARNING

For your safety, only change the Settings after parking the vehicle at a safe location.

### Warning Volume

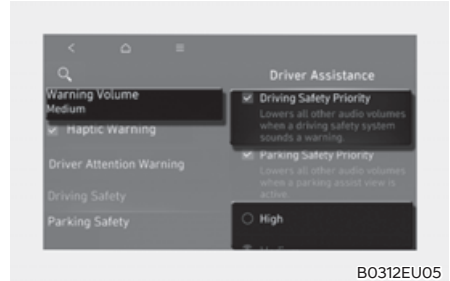

B0312EU05

With the engine on, select 'Driver Assistance → Warning volume' or 'Sound → Driver Assistance' from the Settings menu to change the Warning Volume to 'High', 'Medium', 'Low' or 'Off' for Highway Driving Assist.

If 'Driving Safety Priority' is selected, the vehicle lowers all other audio volumes when the warning sounds for safe driving.

#### **i** Information

- If 'Off' is selected, the Hands-off Warning Volume will not turn off, but the volume will sound as 'Low'.
- If you change the Warning Volume, the Warning Volume of other Driver Assistance systems may change.

## Highway Driving Assist Operation

### Basic function

#### Displaying operating status

You can see the status of the Highway Driving Assist operation in the Driving Assist view on the cluster. Refer to “View Modes” section in chapter 4.

Highway Driving Assist will be displayed as below depending on the status of the function.

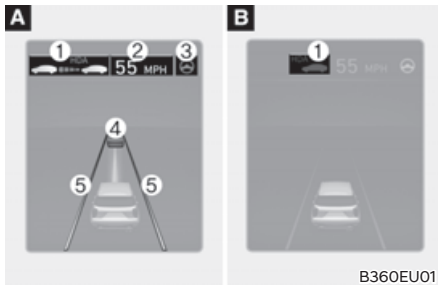

B360EU01

Ⓐ: Operating state, Ⓑ: Standby state

- (1) Highway Driving Assist indicator, whether there is a vehicle ahead and the selected distance level
  - \* Highway Driving Assist indicator
    - Green HDA : Operating state
    - Grey HDA : Ready state
    - White HDA blink: Accelerator depressed state
- (2) Set speed
- (3) Lane Following Assist indicator
- (4) Whether there is a vehicle ahead and the selected headway
- (5) Whether the lane is detected or not

### **i** Information

- For more details on the display refer to “Smart Cruise Control (SCC)” and “Lane Following Assist (LFA)” sections in this chapter.
- The images and colors in the instrument cluster may differ depending on the cluster type or theme selected from the settings menu.

#### Highway Driving Assist operation

Highway Driving Assist operates when:

- Driving on the main road of highways, and turning on Highway Driving Assist by pressing the Driving Assist button.
- Entering the main road of highways while Lane Following assist and Smart Cruise Control are operating

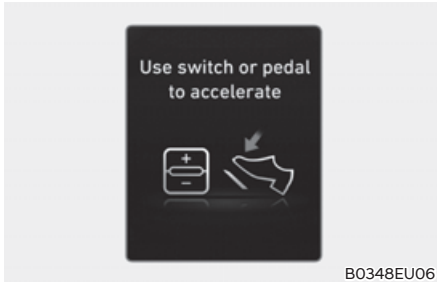

### Restarting after stopping

When Highway Driving Assist is operating, your vehicle will stop if the vehicle ahead of you stops. Also, if the vehicle ahead of you starts moving within 30 seconds after the stop, your vehicle will start as well. In addition, after the vehicle has stopped and 30 seconds have passed, the 'Use switch or pedal to accelerate' message will appear on the cluster. Depress the accelerator pedal or operate the + switch, - switch or  switch to start driving.



### Hands-off warning

If the driver takes their hands off the steering wheel for several seconds, the 'Keep hands on steering wheel' warning message will appear and an audible warning will sound in stages.

First stage : Warning message

Second stage : Warning message (red steering wheel) and audible warning

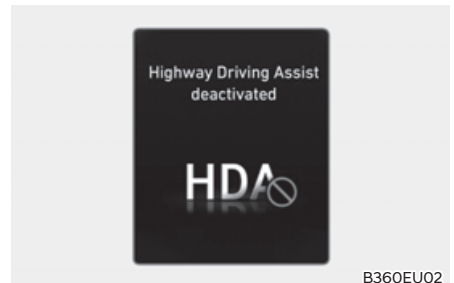

If the driver still does not have their hands on the steering wheel after the hands-off warning, the 'Highway Driving Assist deactivated' warning message will appear and Highway Driving Assist and Lane Change Assist will be automatically canceled.



### Driving speed limit

When Highway Driving Assist is canceled by the hands-off warning, The driving speed will be limited.

While Driving Speed Limit function is operating, the 'Driver's grasp not detected. Driving speed will be limited' warning message will appear on the cluster, and an audible warning will sound continuously.

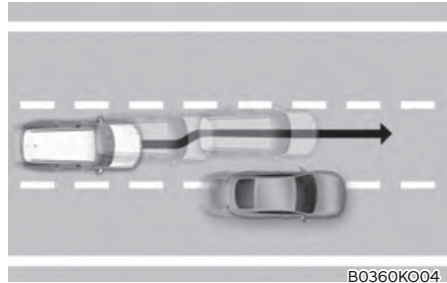

### Driving to one side within lane (if equipped)

When vehicle speed is above 40 mph (60 km/h), if a vehicle around you is driving at a close distance, your vehicle will control steering in the opposite direction of the vehicle to assist in safe driving.

If there are vehicles in both sides of the lane that are driving close to you, the function will not veer to the opposite side of the lane.

### Highway Driving Assist standby

When the Smart Cruise Control is temporarily canceled while Highway Driving Assist is operating, Highway Driving Assist will be in the standby state. At this time, Lane Following Assist will operate properly.

## **i** Information

- **Driving Speed Limit** helps you drive below 40 mph (60 km/h). At this time, the vehicle decelerates due to the vehicle ahead. After the vehicle has decelerated, it cannot automatically accelerate.
- **Driving Speed Limit will cancel in the following circumstances:**
  - When the driver grabs the steering wheel again
  - When the driver turns on Lane Following Assist by pressing the Lane Driving Assist button
  - When +, -, || ⊙ switch or  button is operated, or the accelerator pedal or the brake pedal is depressed

## **Highway Lane Change Assist (if equipped)**



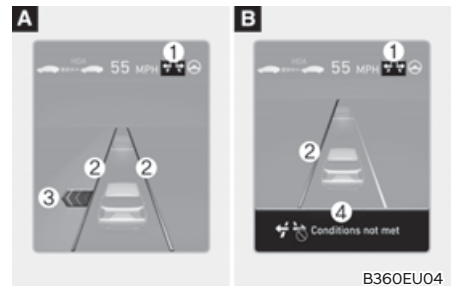

### Displaying operating status

You can see the status of the Highway Lane Change Assist function operation in the Driving Assist view on the cluster. Refer to “View Modes” section in chapter 4.

Highway Lane Change Assist function will be displayed as below depending on the status of the function.



Ⓐ: Ready/Operating, Ⓑ: Standby/Canceled

- (1) Highway Lane Change Assist indicator
  - Green  on : Ready state
  - Green  blink : Operating state
  - Grey  on : Standby state
  - White  blink : Canceled state
- (2) Green lane line
 

The lane line is displayed same as the Highway Lane Change Assist indicator (1). However, if the function is on standby, it displays whether the lane line is detected.
- (3) Green arrow and shade
 

The green arrow is displayed when a certain amount of time has passed after the function has started operating, and until the lane change has completed.

### (4) Message

- Message is displayed when the function does not operate even though the turn signal lever is used.
- Message is displayed when the function is canceled while operating.

### To turn on Highway Lane Change Assist

Highway Lane Change Assist function will turn on when the following conditions are satisfied.

- The Driving Assist button or Lane Driving Assist button is used to turn on Highway Driving Assist.

### Highway Lane Change Assist ready to operate

While Highway Lane Change Assist function is on, the function will be ready to operate when all the following conditions are satisfied:

- Highway Driving Assist is operating
- Lane Following Assist is operating
- A vehicle in the rear area of your vehicle is detected more than once after the engine is turned on
- Your vehicle speed is above 40 mph (60 km/h)
- Hands-off warning is not displayed on the cluster
- Hazard warning flasher is off

### Information

- While Lane Change Assist function is turned on (indicator on), Lane Following Assist will not cancel even if the turn signal indicator or hazard warning flasher is operating.
- Lane Change Assist function turns off automatically when driven in the following road conditions:
  - One driving lane
  - A road with a intersection or crosswalk ahead
  - A road with no structure, such as a medium strip, guardrails, etc.
  - There is a pedestrian or cyclist on the road ahead
- When the function is in the ready state, and vehicle speed is below 35 mph (55 km/h), the function will change to the standby state.

### WARNING

**When Highway Lane Change Assist function turns off while operating, steering assist will be temporarily canceled. Always be cautious while driving.**

## Highway Lane Change Assist operating

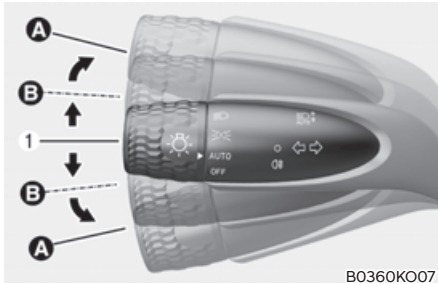

B0360KO07

①: Center

Highway Lane Change Assist function will operate, when you push the turn signal lever up or down to the (A) or (B) position while the function is in the ready state (↔ indicator is green), and all of the following conditions are satisfied:

- The driver has his/her hand on the steering wheel
- There is no collision risk in the direction of lane change
- There is a single dotted lane line in the direction of lane change
- There are no Forward Collision-Avoidance Assist and Blind Spot Collision-Avoidance Warning
- The vehicle is driven in the middle of the lane (should not be driving close to one side of the lane)
- The road you are driving on, or the road you are about to change lane is a road that the function can operate

## **i** Information

- **Highway Lane Change Assist operates when the turn signal lever is positioned at A. If the turn signal lever is released to the center (1) before stepping on the lane, Highway Lane Change Assist cancels. If the turn signal lever is released to the center (1) after stepping on the lane, Highway Lane Change Assist changes the lane and turns off the turn signal after lane change is complete.**

- **When the turn signal lever is placed at B position for a certain period of time, the green arrow will appear. At this time, even when the lever is released and returns to its original position (1), lane change will still be assisted.**
- **While lane change is being made by the function, the turn signal indicator will blink even when the turn signal lever is not held, and the turn signal indicator will turn off when lane change is complete.**
- **Highway lane change assist does not operate on the entrance or exit of the highway.**

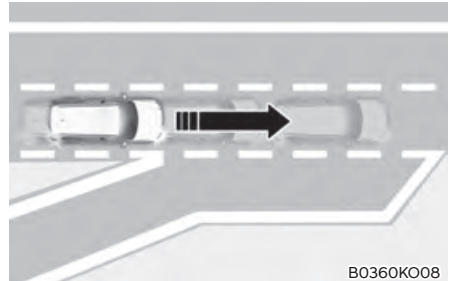

B0360KO08

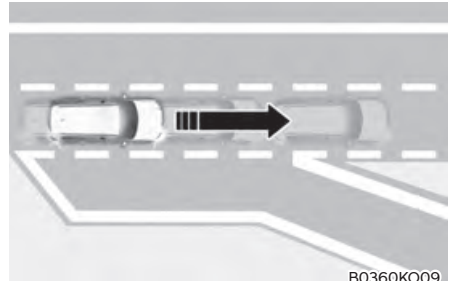

B0360KO09

### Highway Lane Change Assist standby

Highway Lane Change Assist function will be in the standby state when one of the ready state condition is not satisfied, or when entering or driving on one of the following roads:

- Road within a certain distance from the tollgate on the main road of the highway (or motorway)
- The road ahead ends without an interchange or junction
- Road with sharp curves
- Road with narrow lanes

### Highway Lane Change Assist cancel

The function will be canceled when:

- The turn signal lever is moved to the A position while the Highway Lane Change Assist function is operating and placed in the center (1) before stepping on the lane line
- The turn signal lever is turned on in the opposite direction of lane change
- The steering wheel is steered sharply



### WARNING

- **While Highway Driving Assist is operating, the function will cancel if one of the following occurs:**
  - Highway Driving Assist is turned off
  - Lane Following Assist or Smart Cruise Control is turned off or temporarily canceled
  - Hands-off warning message is displayed on the cluster
  - The hazard warning flasher is turned on
  - Forward Collision-Avoidance Assist or Blind-Spot Collision Warning warning message is displayed
  - Possible collision is detected in the next lane, even though there are no Forward Collision-Avoidance Assist and Blind Spot Collision-Avoidance warning
  - The target lane to make a lane change disappears
  - The target lane to make a lane change is not detected
  - There is a problem with turn signal lamps
  - Highway Lane Change Assist function is off (The function turns off when the function is turned off from the settings menu, when the road changes to a one-way road, when there is an intersection or crosswalk ahead, when you enter a road with no structure, such as a medium strip, guardrail, etc., or when there is a pedestrian or cyclist on the driving lane.)
  - Your vehicle speed is below 35 mph (55km/h)



- While the function is operating, when the function is canceled, depending on the driving conditions, the vehicle may drive to the middle of the driving lane or steering assist may stop. Always pay attention to road and driving conditions while driving.
- The function may not operate properly on roads with pedestrians or cyclists, such as an intersection or crosswalk. Always pay attention to road and driving conditions while driving.

## Highway Driving Assist Malfunction and Limitations

### Highway Driving Assist malfunction



When Highway Driving Assist or Highway Lane Change function is not working properly, the 'Check Highway Driving Assist (HDA) system' or 'Check Lane Change Assist function' warning message will appear, and the  warning light will illuminate on the cluster. Have the vehicle inspected by an authorized HYUNDAI dealer.



## WARNING

- The driver is responsible for controlling the vehicle for safe driving.
- Always have your hands on the steering wheel while driving.
- Highway Driving Assist is a supplemental function that assists the driver in driving the vehicle and is not a complete autonomous driving system. Always check road conditions, and if necessary, take appropriate actions to drive safely.
- Always have your eyes on the road, and it is the responsibility of the driver to avoid violating traffic laws. The vehicle manufacturer is not responsible for any traffic violation or accidents caused by the driver.
- Highway Driving Assist may not be able to recognize all traffic situations. Highway Driving Assist may not detect possible collisions due to limitations of the function. Always be aware of the limitations of the function. Obstacles such as vehicles, motorcycles, bicycles, pedestrians, or unspecified objects or structures such as guardrails, tollgate, etc., that may collide with the vehicle may not be detected.
- Highway Driving Assist will turn off automatically under the following situations:
  - Driving on roads that Highway Driving Assist does not operate, such as a rest area, intersection, junction, etc.
  - The navigation does not operate properly such as when the navigation is being updated or restarted
- Highway Driving Assist may inadvertently operate or turn off depending on road conditions (navigation information) and surroundings.
- Lane Following Assist function may be temporarily disabled when the front view camera cannot detect lanes properly or the hands-off warning is on.
- You may not hear the warning sound of Highway Driving Assist if the surrounding is noisy.
- If the vehicle is driven at high speed above a certain speed at a curve, your vehicle may drive to one side or may depart from the driving lane.
- When you are towing a trailer or another vehicle, turn off Highway Driving Assist for safety reasons.
- The hands-off warning message may appear early or late depending on how the steering wheel is held or road conditions. Always have your hands on the steering wheel while driving.
- For your safety, please read the owner's manual before using the Highway Driving Assist.
- Highway Driving Assist will not operate when the engine is started, or when the detecting sensors or navigation is being initialized.

## **Limitations of Highway Driving Assist**

Highway Driving Assist and Highway Lane Change function may not operate properly, or may not operate under the following circumstances:

- The map information and the actual road is different because the navigation is not updated
- The map information and the actual road is different because of real-time GPS data or map information error
- The infotainment system is overloaded by simultaneously performing functions such as route search, video playback, voice recognition, etc.
- GPS signals are blocked in areas such as a tunnel
- The driver goes off course or the route to the destination is changed or canceled by resetting the navigation
- The vehicle enters a service station or rest area
- Android Auto or Car Play is operating
- The navigation cannot detect the current vehicle position (for example, elevated roads including overpass adjacent to general roads or nearby roads exist in a parallel way)
- White single dotted lane line or road edge cannot be detected
- The road is temporarily controlled due to construction, etc.
- There is no structure, such as a medium strip, guardrails, etc., on the road
- There is a changeable lane in the direction of lane change

## **i Information**

**For more details on the limitations of the front view camera, front radar, front corner radar and rear corner radar, refer to “Forward Collision-Avoidance Assist (FCA)” section in this chapter.**

## **i Information**

**This device complies with Part 15 of the FCC rules.**

**Operation is subject to the following three conditions:**

1. **This device may not cause harmful interference, and**
2. **This device must accept any interference received, including interference that may cause undesired operation.**
3. **Changes or modifications not expressly approved by the party responsible for compliance could void the user's authority to operate the device.**

## **i Information**

**Radio frequency radiation exposure information:**

**This equipment complies with FCC radiation exposure limits set forth for an uncontrolled environment.**

**This equipment should be installed and operated with minimum distance of 8 in. (20 cm) between the radiator (antenna) and your body.**

**This transmitter must not be co-located or operating in conjunction with any other antenna or transmitter.**

## REAR VIEW MONITOR (RVM) (IF EQUIPPED)

Rear View Monitor shows the area behind the vehicle to assist you when parking or backing up.

### Detecting sensor

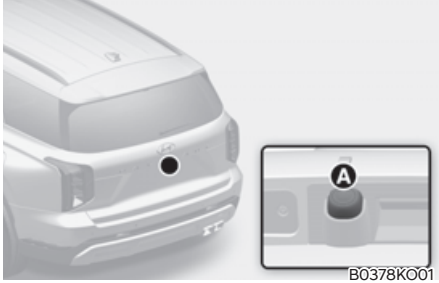

Ⓐ: Wide-rear view camera

Refer to the picture above for the detailed location of the detecting sensor.

## Rear View Monitor Settings

### Warning Volume

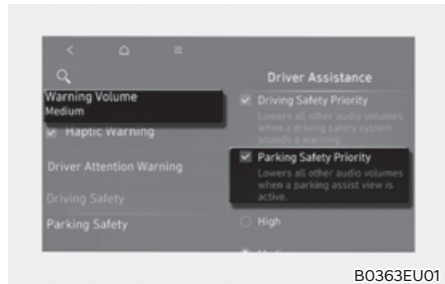

With the engine on, select 'Driver Assistance → Warning Volume → Parking Safety Priority' or 'Sound → Driver Assistance → Parking Safety Priority' from the Setting menu.

If 'Parking Safety Priority' is selected, the vehicle lowers all other audio volumes when Rear View Monitor is operating for safe parking.

## Camera settings

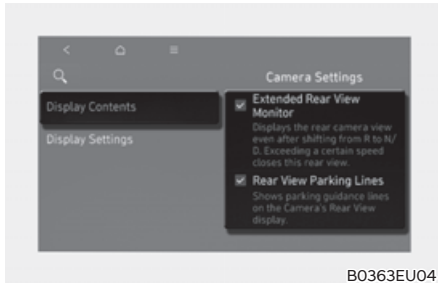

You can change Rear View Monitor 'Display Contents' by touching the setup icon (⚙️) on the screen while Rear View Monitor is operating, or selecting 'Driver Assistance → Parking Safety → Camera Settings' from the Settings menu while the engine is on.

### Extended Rear View Monitor

Keeps displaying the rear view when shifting from R (Reverse) to N (Neutral) or D (Drive). When exceeding a certain speed, the rear view stops displaying.

### Rear View Parking Guide Lines

If 'Rear view Parking Lines' is selected, the rear view parking guide lines and reartop view guide lines will be displayed at the left side of the infotainment systemscreen.

### **i** Information

- **The horizontal guideline of the Rear View Parking Guidance shows the distance of 1.6 ft. (0.5 m), 3.3 ft. (1 m) and 7.6 ft. (2.3 m.) from the vehicle.**
- **The horizontal guideline of the Rear Top View Parking Guidance shows the liftgate opening distance and the distance of 4.9 ft. (1.5 m) from the vehicle.**

## Rear View Monitor Operation

### Parking/View button



Press the Parking/View button ① while the gear is in P (Park) to turn on Rear View Monitor.

### Rear view



### Operating conditions

- Shift the gear to R (Reverse), the rear view will appear on the screen.
- Press the Parking/View button (1) while the gear is in P (Park), the rear view will appear on the screen.
- Touch the , the rear view will appear on the screen.

### Off conditions

- The rear view cannot be turned off when the gear is in R (Reverse).
- Press the Parking/View button (1) again while the gear is in P (Park) with the rear view on the screen, the rear view will turn off.
- Shift the gear from R (Reverse) to P (Park), the rear view will turn off.

### Information

**When the gear is in P (Park), the rear view does not turn off.**

## Rear top view



When you touch the  icon, the top view is displayed on the screen and shows the distance from the vehicle in the back of your vehicle while parking.

## Extended Rear View Monitor

Extended Rear View Monitor function maintains showing the rear view when the gear is R (Reverse), N (Neutral) or D (Drive).

### Operating conditions

The gear is in P (Park), N (Neutral) or D (Drive), and vehicle speed is 6 mph (10 km/h) or less.

### Off conditions

- When vehicle speed is above 6 mph (10 km/h), the rear view will turn off.
- Shift the gear to P (Park), the rear view will turn off.
- Press the Parking/View button , the rear view will turn off.

## Rear View Monitor Malfunction and Limitations

### Rear View Monitor malfunction

When Rear View Monitor is not working properly, or the screen flickers, or the camera image does not display properly, have the vehicle inspected by an authorized HYUNDAI dealer.

### Limitations of Rear View Monitor

When the vehicle is stopped for a long time in winter or when the vehicle is parked in an indoor parking lot, the exhaust fumes may temporarily blur the image.



## WARNING

- The rear view camera does not cover the complete area behind the vehicle. The driver should always check the rear area directly through the inside and side view mirror before parking or backing up.
- The image shown on the screen may differ from the actual distance of the object. Make sure to directly check the vehicle's surroundings for safety.
- Always keep the rear view camera lens clean. If the lens is covered with foreign material, it may adversely affect camera performance and Rear View Monitor may not operate properly. However, do not use chemical solvents such as strong detergents containing high alkaline or volatile organic solvents (gasoline, acetone, etc.). This may damage the camera lens.

## SURROUND VIEW MONITOR (SVM) (IF EQUIPPED)

Surround View Monitor can assist in parking by allowing the driver to see around the vehicle.

### Detecting sensor

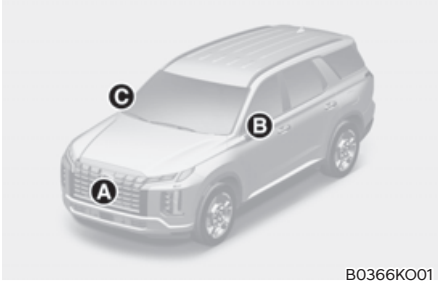

- Ⓐ: Wide-front view camera,
- Ⓑ, Ⓒ: Wide-side view camera  
(Below the side view mirror),
- Ⓓ: Wide-rear view camera

Refer to the picture above for the detailed location of the detecting sensors.

## Surround View Monitor Settings Warning Volume

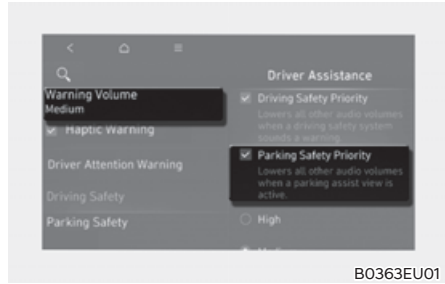

With the engine on, select 'Driver Assistance → Warning Volume → Parking Safety Priority' or 'Sound → Driver Assistance → Parking Safety Priority' from the Setting menu.

If 'Parking Safety Priority' is selected, the vehicle lowers all other audio volumes when Surround View Monitor is operating for safe parking.



## Camera settings

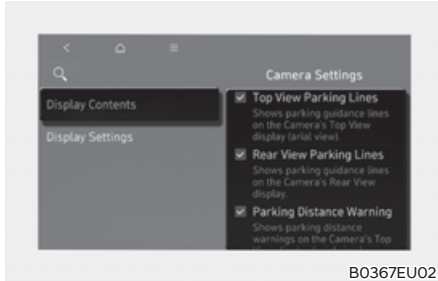

B0367EU02

- You can change Surround View Monitor 'Display Contents' or 'Display Settings' by touching the setup icon (⚙️) on the screen while Surround View Monitor is operating, or selecting 'Driver Assistance → Parking Safety → Camera Settings' from the Settings menu while the engine is on.
- In the Display Contents, you can change settings for 'Top View Parking Lines', 'Rear View Parking Lines' and 'Parking Distance Warning'.

### Top View Parking Guidance

When the 'Top View Parking Lines' is selected, parking guidance is displayed on the right side of the Surround View Monitor screen.

### **i** Information

The horizontal guideline shows the liftgate opening distance and 6.6 ft. (2 m) from the vehicle.

### Rear View Parking Guidance

When the 'Rear View Parking Lines' is selected, parking guidance is displayed in the rear view.

### **i** Information

The horizontal guideline shows the distance of 1.6 ft. (0.5 m), 3.3 ft. (1 m) and 7.6 ft. (2.3 m) from the vehicle.



B0367EU01

### Parking Distance Warning

When the 'Parking Distance Warning' is selected, parking distance warning is displayed on the right side of the Surround View Monitor screen.

### Surround View Monitor Auto On

With the engine on, select 'Driver Assistance → Parking Safety → Surround View Monitor Auto On' from the Settings menu to use the function.

## Surround View Monitor Operation

### Parking/View button



Press the Parking/View button ① to turn on Surround View Monitor.  
Press the button again to turn off the function.

### Front view



The front image is displayed on the screen when the gear is in N (Neutral) or D (Drive) to assist in parking. Using the view button ② you may select top view, front view, side view and 3D view.

### Operating conditions

- The gear is in N (Neutral) or D (Drive), and vehicle speed is 6 mph (10 km/h) or less.
- The Parking/View button ① is pressed, while the gear is in N (Neutral) or D (Drive), and vehicle speed is 6 mph (10 km/h) or less.
- Surround View Monitor Auto On function will operate when the following conditions are satisfied:
  - With 'Driver Assistance → Parking Safety → Surround View Monitor Auto On' selected from the Settings menu, the front view while parking is displayed.

### Off conditions

- The gear is shifted to P (Park).
- The Parking/View button ① or the Infotainment system button ③ is Pressed.
- Vehicle speed is above 6 mph (10 Km/h).

### Rear view

The rear image is displayed on the screen when the gear is in P (Park) to assist in parking. Using the view button ② you may select top view, front view, side view and 3D view.

#### Operating conditions

- The gear is shifted to R (Reverse)
- The Parking/View button ① is pressed, while the gear is in P (Park)

#### Off conditions

- The gear is shifted from R (Reverse) to P (Park)
- The Parking/View button ① is pressed, while the gear is in P (Park)



### Information

**When the gear is in R (Reverse), the rear view does not turn off.**

### 3D view

The 3D view shows the image around the vehicle from various angles.

You can change angles by tapping the screen. Press the 3D View button again to return to the initial angle.

3D view will turn on when the 3D view is selected among the view buttons ① under the following conditions:

- The gear is in P (Park), N (Neutral) or D (Drive) when vehicle speed is below 6 mph (10 km/h).
- The Surround View Monitor is turned on when the gear is in R (Reverse).

When the gear is in P (Park), N (Neutral) or D (Drive), 3D view will turn off under the following conditions:

- The gear is shifted to P (Park).
- The Parking/View button ① is pressed.
- The infotainment system button ③ is pressed.
- The Home button ① is pressed.
- Vehicle speed is above 6 mph (10 km/h).



### Information

**3D view does not display guidelines.**

## Surround View Monitor Malfunction and Limitations

### Surround View Monitor malfunction

When Surround View Monitor is not working properly, or the screen flickers, or the camera image does not display properly, have the vehicle inspected by an authorized HYUNDAI dealer.

### Limitations of Surround View Monitor

- When the vehicle is stopped for a long time in winter or when the vehicle is parked in an indoor parking lot, the exhaust fumes may temporarily blur the image.
- The screen may be displayed abnormally, and an icon will appear at the top left side of the screen under the following circumstances:
  - The liftgate is opened
  - The driver or front passenger door is opened
  - The side view mirror is folded



### WARNING

- **ALWAYS** look around your vehicle to make sure there are no objects or obstacles before moving the vehicle. What you see on the screen may differ from the actual vehicle's location.
- The image shown on the screen may differ from the actual distance of the object. Make sure to directly check the vehicle's surroundings for safety.
- Surround View Monitor is designed to be used on a flat surface. Therefore, if used on roads with different heights such as curbs and speed bumps, the image in the screen may not look correct.
- Always keep the camera lens clean. If the lens is covered with foreign material, it may adversely affect camera performance and Surround View Monitor may not operate properly. However, do not use chemical solvents such as strong detergents containing high alkaline or volatile organic solvents (gasoline, acetone, etc.). This may damage the camera lens.



### Information

Surround View Monitor uses the cameras installed on the vehicle to show images around the vehicle through the infotainment system screen. The image shown on the screen may look unnatural depending on the surroundings.

## REAR CROSS-TRAFFIC COLLISION-AVOIDANCE ASSIST (RCCA) (IF EQUIPPED)

Rear Cross-Traffic Collision-Avoidance Assist is designed to help detect vehicles approaching from the rear left and right side while your vehicle is reversing, and warn the driver that a collision is imminent with a warning message and an audible warning. Also, braking is assisted to help prevent collision.

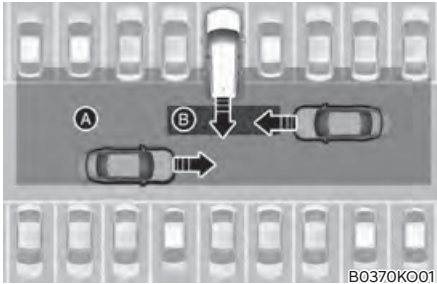

- Ⓐ: Rear Cross-Traffic Collision Warning operating range,
- Ⓑ: Rear Cross-Traffic Collision-Avoidance Assist operating range

### Detecting sensor

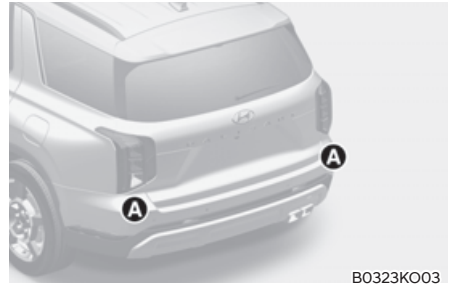

- Ⓐ: Rear corner radar

Refer to the picture above for the detailed location of the detecting sensors.

## Rear Cross-Traffic Collision-Avoidance Assist Settings

### Setting features

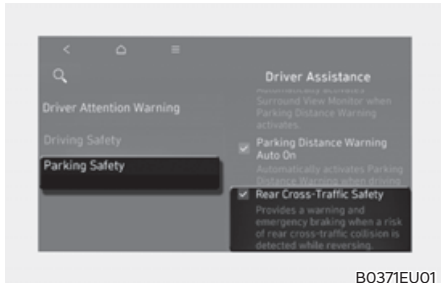

B0371EU01

### Rear Cross-Traffic Safety

With the engine on, select 'Driver Assistance → Parking Safety → Rear Cross-Traffic Safety' from the Settings menu to turn on Rear Cross-Traffic Collision-Avoidance Assist and deselect to turn off the function.

### WARNING

When the engine is restarted, Rear Cross-Traffic Collision-Avoidance Assist will always turn on. However, if 'Off' is selected after the engine is restarted, the driver should always be aware of the surroundings and drive safely.



B0371EU02

### Warning Volume

With the engine on, select 'Driver Assistance → Warning volume' or 'Sound → Driver Assistance' from the Settings menu to change the Warning Volume to 'High', 'Medium', 'Low' or 'Off' for Rear Cross-Traffic Collision-Avoidance Assist.

### Information

- If you change the Warning Volume, the Warning Volume of other Driver Assistance systems may change.
- If 'Off' is selected, steering wheel vibration will not turn off.

## Rear Cross-Traffic Collision-Avoidance Assist Operation

Rear Cross-Traffic Collision-Avoidance Assist will warn and help control the vehicle depending on collision risk level: 'Collision Warning', 'Emergency Braking' and 'Stopping vehicle and ending brake control'.

### Collision Warning

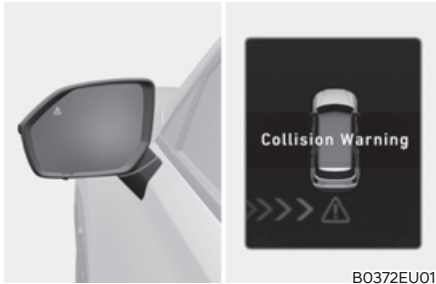

B0372EU01



B0372EU02

- Rear Cross-Traffic Collision-Avoidance Assist will operate when all the following conditions are satisfied:
  - The gear is shifted to R (Reverse)
  - Vehicle speed is below 5 mph (8 km/h)
  - The approaching vehicle is within approximately 82 ft. (25 m) from the left and right side of your vehicle
  - The speed of the vehicle approaching from the left and right is above 3 mph (5 km/h)

### **i** Information

- **If the operating conditions are satisfied, there will be a warning whenever the vehicle approaches from the left or right side even though your vehicle speed is 0 mph (0 km/h).**
- **The images and colors in the cluster may differ depending on the cluster type or theme selected from the cluster.**
- To warn the driver of an approaching vehicle from the rear left/right side of your vehicle, the warning light on the side view mirror will blink and a warning will appear on the cluster. At the same time, an audible warning will sound and the steering wheel will vibrate. If Rear View Monitor is operating, a warning will also appear on the infotainment system screen.

## Emergency Braking



B0372EU03



B0372EU02

- To warn the driver of an approaching vehicle from the rear left/right side of your vehicle, the warning light on the side view mirror will blink and a warning message will appear on the cluster. At the same time, an audible warning will sound and the steering wheel will vibrate. A warning will also appear on the infotainment system screen.

- Rear Cross-Traffic Collision-Avoidance Assist will operate when all the following conditions are satisfied:
  - The gear is shifted to R (Reverse)
  - Vehicle speed is below 5 mph (8 km/h)
  - The approaching vehicle is within approximately 5 ft. (1.5 m) from the left and right side of your vehicle
  - The speed of the vehicle approaching from the left and right is above 3 mph (5 km/h)
- Emergency braking will be assisted to help prevent collision with approaching vehicles from the left and right.

### **WARNING**

**Brake control will end when:**

- **The approaching vehicle is out of the detecting range**
- **The approaching vehicle passes behind your vehicle**
- **The approaching vehicle does not drive toward your vehicle**
- **The approaching vehicle speed slows down**
- **The driver depresses the brake pedal with sufficient power**



## Stopping vehicle and ending brake control

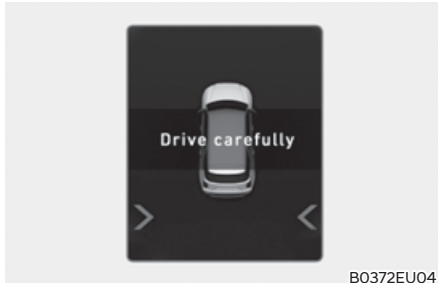

B0372EU04

- When the vehicle is stopped due to emergency braking, the 'Drive carefully' warning message will appear on the cluster.
- For your safety, the driver should depress the brake pedal immediately and check the surroundings.
- Brake control will end after the vehicle is stopped by emergency braking for approximately 2 seconds.
- During emergency braking, braking control by Rear Cross-Traffic Collision-Avoidance Assist will automatically cancel when the driver excessively depresses the brake pedal.



### WARNING

Take the following precautions when using Rear Cross-Traffic Collision-Avoidance Assist:

- For your safety, only change the Settings after parking the vehicle at a safe location.
  - If any other system's warning message is displayed or audible warning is generated, Rear Cross-Traffic Collision-Avoidance Assist warning message may not be displayed and audible warning may not be generated.
- You may not hear the warning sound of Rear Cross-Traffic Collision-Avoidance Assist if the surrounding is noisy.
  - Rear Cross-Traffic Collision-Avoidance Assist may not operate if the driver applies the brake pedal to avoid collision.
  - During Rear Cross-Traffic Collision-Avoidance Assist operation, the vehicle may stop suddenly injuring passengers and shifting loose objects. Always have the seat belt on and keep loose objects secured.
  - Even if there is a problem with Rear Cross-Traffic Collision-Avoidance Assist, the vehicle's basic braking performance will operate properly.
  - When Rear Cross-Traffic Collision-Avoidance Assist is operating, braking control by the function will automatically cancel when the driver excessively depresses the accelerator pedal.
  - Rear Cross-Traffic Collision-Avoidance Assist does not operate in all situations or cannot avoid all collisions.
  - Rear Cross-Traffic Collision-Avoidance Assist may warn the driver late or may not warn the driver depending on the road and driving conditions.
  - The driver has the responsibility to control the vehicle. Do not solely depend on Rear Cross-Traffic Collision-Avoidance Assist. Rather, maintain a safe braking distance, and if necessary, depress the brake pedal to reduce driving speed or to stop the vehicle.
  - Never deliberately operate Rear Cross-Traffic Collision-Avoidance Assist on people, animal, objects, etc. It may cause serious injury or death.



## CAUTION

The brake control may not operate properly depending on the status of ESC (Electronic Stability Control).

There will only be a warning when:

- The ESC (Electronic Stability Control) warning light is on
- ESC (Electronic Stability Control) is engaged in a different function



## Information

If braking is assisted by Rear Cross-Traffic Collision-Avoidance Assist, the driver must immediately depress the brake pedal and check vehicle surroundings.

- Brake control will end when the driver depresses the brake pedal with sufficient power.
- After shifting the gear to R (Reverse), braking control will operate once for left and right vehicle approach.

## Rear Cross-Traffic Collision-Avoidance Assist Malfunction and Limitations

### Rear Cross-Traffic Collision-Avoidance Assist malfunction

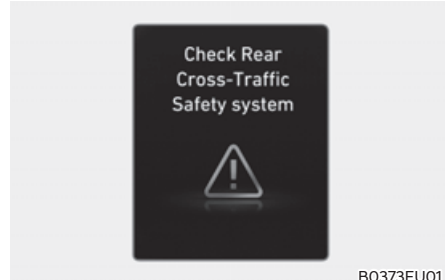

When Rear Cross-Traffic Collision-Avoidance Assist is not working properly, the 'Check Rear Cross-Traffic Safety system' warning message will appear on the cluster for several seconds, and the master (⚠) warning light will illuminate on the cluster. If this occur, have the vehicle inspected by an authorized HYUNDAI dealer.

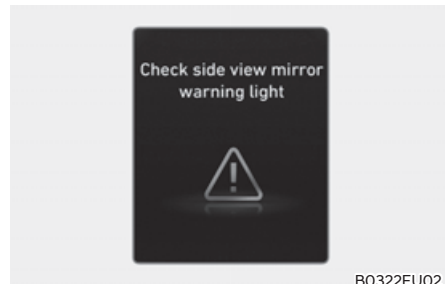

When the side view mirror warning light is not working properly, the 'Check side view mirror warning light' warning message will appear on the cluster for several seconds, and the master (⚠) warning light will illuminate on the cluster. If this occur, have the vehicle inspected by an authorized HYUNDAI dealer.

### **Rear Cross-Traffic Collision-Avoidance Assist disabled**

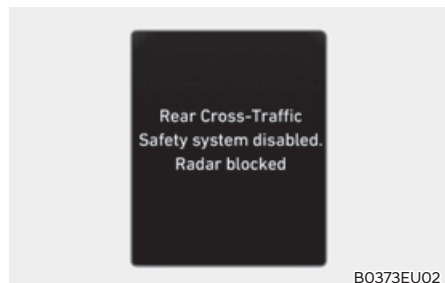

When the rear bumper around the rear-side radar or sensor is covered with foreign material, such as snow or rain, or installing a trailer or carrier, it can reduce the detecting performance and temporarily limit or disable Rear Cross-Traffic Collision-Avoidance Assist.

If this occurs, the 'Rear Cross-Traffic Safety system disabled. Radar blocked' warning message will appear on the cluster.

Rear Cross-Traffic Collision-Avoidance Assist will operate properly when such foreign material or trailer, etc., is removed.

If Rear Cross-Traffic Collision-Avoidance Assist does not operate properly after it is removed, have the vehicle inspected by an authorized HYUNDAI dealer.

### **WARNING**

- Even though the warning message does not appear on the cluster, Rear Cross-Traffic Collision-Avoidance Assist may not operate properly.
- Rear Cross-Traffic Collision-Avoidance Assist may not operate properly in an area (for example, open terrain), where any objects are not detected after turning ON the engine.

### **CAUTION**

Turn off Rear Cross-Traffic Collision-Avoidance Assist to install or remove a trailer, carrier, or another attachment. Turn on Rear Cross-Traffic Collision-Avoidance Assist when finished.

### **Limitations of Rear Cross-Traffic Collision-Avoidance Assist**

Rear Cross-Traffic Collision-Avoidance Assist may not operate properly, or it may operate unexpectedly under the following circumstances:

- Departing from where trees or grass are overgrown
- Departing from where roads are wet
- Speed of the approaching vehicle is fast or slow

Braking control may not work, driver's attention is required in the following circumstances:

- The vehicle severely vibrates while driving over a bumpy road, uneven road or concrete patch
- Driving on a slippery surface due to snow, water puddle, ice, etc.
- The tire pressure is low or a tire is damaged
- The braking system has been modified
- Remote Smart Parking Assist is operating (if equipped)

### **Information**

For more details on the limitations of the rear corner radar, refer to "Blind-Spot Collision Warning (BCW)" section in this chapter.



## WARNING

- Driving near a vehicle or structure

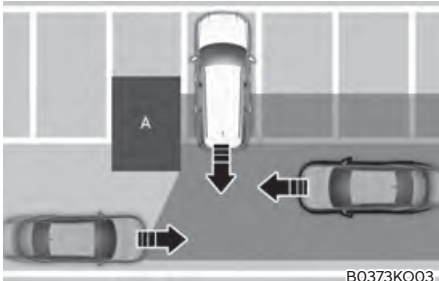

Ⓐ: Structure

Rear Cross-Traffic Collision-Avoidance Assist may be limited when driving near a vehicle or structure, and may not detect the vehicle approaching from the left or right. If this occurs, the function may not warn the driver or control the brakes when necessary.

Always check your surroundings while backing up.

- When the vehicle is in a complex parking environment

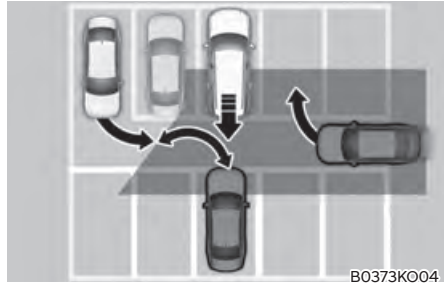

Rear Cross-Traffic Collision-Avoidance Assist may detect vehicles which are parking or pulling out near your vehicle (for example, a vehicle leaving beside your vehicle, a vehicle parking or pulling out in the rear area, a vehicle approaching your vehicle making a turn, etc.). If this occurs, the function may unnecessarily warn the driver and control the brake.

Always check your surroundings while backing up.

- When the vehicle is parked diagonally

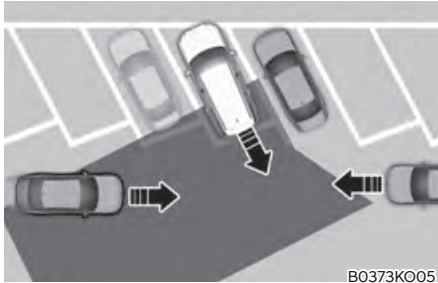

Rear Cross-Traffic Collision-Avoidance Assist may be limited when backing up diagonally, and may not detect the vehicle approaching from the left or right. If this occurs, the function may not warn the driver or control the brakes when necessary.

Always check your surroundings while backing up.

- When the vehicle is on or near a slope

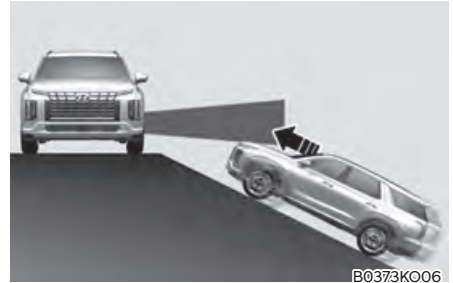

Rear Cross-Traffic Collision-Avoidance Assist may be limited when the vehicle is on a uphill or downhill slope, or near it, and may not detect the vehicle approaching from the left or right. If this occurs, the function may not warn the driver or control the brakes when necessary.

Always check your surroundings while backing up.

- Pulling into the parking space where there is a structure

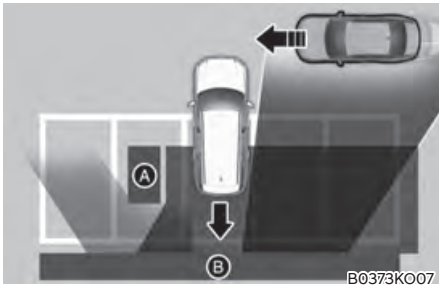

Ⓐ: Structure, Ⓑ: Wall

**Rear Cross-Traffic Collision-Avoidance Assist** may detect vehicles passing by in front of you when parking in reverse into a parking space with a wall or structure in the rear or side area. If this occurs, the function may unnecessarily warn the driver and control the brake.

Always check your surroundings while backing up.

- When the vehicle is parked rearward

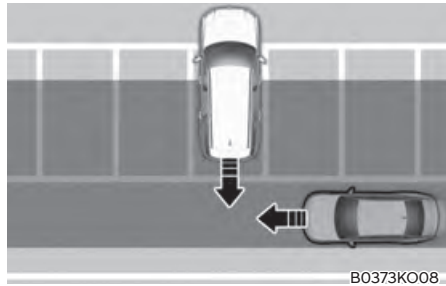

**Rear Cross-Traffic Collision-Avoidance Assist** may detect vehicles passing by behind you when parking in reverse into a parking space. If this occurs, the function may unnecessarily warn the driver and control the brake.

Always check your surroundings while backing up.

### **WARNING**

- When you are towing a trailer or turn off **Rear Cross-Traffic Collision-Avoidance Assist** for safety reasons.
- **Rear Cross-Traffic Collision-Avoidance Assist** may not operate properly if interfered by strong electromagnetic waves.
- **Rear Cross-Traffic Collision-Avoidance Assist** may not operate for 15 seconds after the vehicle is started, or the rear corner radars are initialized.

## **i** Information

**This device complies with Part 15 of the FCC rules.**

**Operation is subject to the following three conditions:**

- 1. This device may not cause harmful interference, and**
- 2. This device must accept any interference received, including interference that may cause undesired operation.**
- 3. Changes or modifications not expressly approved by the party responsible for compliance could void the user's authority to operate the device.**

## **i** Information

**Radio frequency radiation exposure information:**

**This equipment complies with FCC radiation exposure limits set forth for an uncontrolled environment.**

**This equipment should be installed and operated with minimum distance of 8 in. (20 cm) between the radiator (antenna) and your body.**

**This transmitter must not be co-located or operating in conjunction with any other antenna or transmitter.**

## REVERSE PARKING DISTANCE WARNING (PDW) (IF EQUIPPED)

Parking Distance Warning will help warn the driver if an obstacle is detected within a certain distance when the vehicle is moving forward or in reverse at low speeds.

### Detecting sensor



B1101EU01

Ⓐ: Rear ultrasonic sensors,

Refer to the picture above for the detailed location of the detecting sensors.

## Reverse Parking Distance Warning Settings

### Warning volume

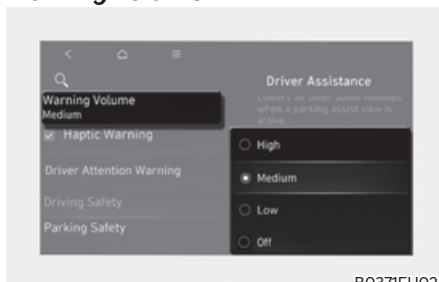

B0371EU02

With the vehicle on, select 'Driver assistance → Warning volume' from the Settings menu to change the Warning volume to 'High', 'Medium', 'Low' or 'Off' for Parking Distance Warning.

### **i** Information

**If you change the Warning volume, the Warning volume of other Driver Assistance systems may change.**

### **i** Information

**When Parking Distance Warning Auto On is selected, the Parking Safety button indicator (P/A) stays on.**



## Parking Distance Warning Operation

### Parking Safety button

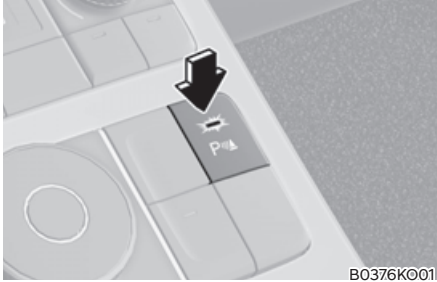

B0376K001

- Press the Parking Safety (P $\triangle$ ) button to turn on Forward/Reverse Parking Distance Warning. Press the button again to turn off the function.
- When the gear is shifted to R (Reverse), Parking Distance Warning will automatically turn on (Parking Safety button indicator on).
- When the gear is in R (Reverse), Parking Distance Warning does not turn off even if the Parking Safety button (P $\triangle$ ) is pressed.

### Reverse Parking Distance Warning

Reverse Parking Distance Warning will operate under the following conditions.

- The gear is shifted to R (Reverse).
- Vehicle speed is below 6 mph (10 km/h).

Distance from object	Warning indicator when driving backward	Warning sound
24~48 in. (60~120cm)		Buzzer beeps intermittently
12~24 in. (30~60cm)		Beeps more frequently
within 12 in. (30 cm)		Beeps continuously

- The corresponding indicator will illuminate whenever each ultrasonic sensor detects a person, animal or object in its sensing range. Also an audible warning will sound.
- When more than two objects are detected at the same time, the closest one will be warned with an audible warning.
- The shape of the indicator in the illustration may differ from the actual vehicle.

## Reverse Parking Distance Warning Malfunction and Limitations

### Parking Distance Warning malfunction

After starting the vehicle, a beep will sound when the gear is shifted to R (Reverse) to indicate Parking Distance Warning is operating properly.

However, if one or more of the following occurs, first check whether the ultrasonic sensor is damaged or blocked with foreign material. If it still does not work properly, have the vehicle inspected by an authorized HYUNDAI dealer.

- The audible warning does not sound.
- The buzzer sounds intermittently.
- The 'Ultrasonic sensor error or blockage' warning message appears on the cluster.

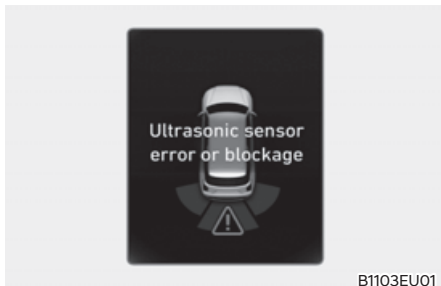
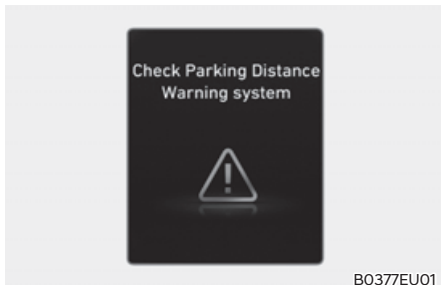

### Parking Distance Warning disabled



If this occurs the 'Parking Distance Warning system limited. Ultrasonic sensor blocked' warning message appears on the instrument cluster. Parking Distance Warning will operate properly when snow, rain or foreign material is removed. If Parking Distance Warning does not operate properly after obstruction (snow, rain, or foreign material) is removed (including trailer, carrier, etc., from the rear bumper), have the vehicle inspected by an authorized HYUNDAI dealer.

### **Limitations of Parking Distance Warning**

- Parking Distance Warning may not operate properly when:
  - Moisture is frozen to the sensor
  - Sensor is covered with foreign substance, such as snow or water (Parking Distance Warning will operate properly when such substance is removed.)
  - The weather is extremely hot or cold
  - The sensor or sensor assembly is disassembled
  - The surface of the sensor is pressed hard or hit with a hard object
  - The surface of the sensor is scratched with a sharp object
  - The sensors or its surrounding area is directly sprayed with high pressure washer
- Parking Distance Warning may malfunction when:
  - Heavy rain or water spray is present
  - Water flows on the surface of the sensor
  - Affected by another vehicle's sensors
  - The sensor is covered with snow or ice
  - Driving on uneven road, gravel roads or bushes
  - Objects that generates ultrasonic waves are near the sensor
  - License plate is installed in a different spot from the original location
  - The vehicle bumper height or ultrasonic sensor installation has been modified
  - Attaching equipment or accessories next to the ultrasonic sensors
- The following objects may not be detected:
  - Sharp or slim objects, such as ropes, chains or small poles.
  - Narrow objects, such as corners of a square column
  - Objects, which tend to absorb sensor frequency, such as clothes, spongy material or snow.
  - Objects smaller than 40 in. (100 cm) in length and narrower than 6 in. (14 cm) in diameter.
  - Pedestrians, animals or objects that are very close to the ultrasonic sensors



## **WARNING**

- **Parking Distance Warning is a supplemental function. The operation of Parking Distance Warning can be affected by several factors (including environmental conditions). It is the responsibility of the driver to always check the front and rear views before and whilst parking.**
- **Your new vehicle warranty does not cover any accidents or damage to the vehicle due to the malfunction of Parking Distance Warning.**
- **Pay close attention when driving near objects, pedestrians, and especially children. Some objects may not be detected by the ultrasonic sensors, due to the objects distance, size or material, all of which can limit the effectiveness of the sensor.**
- **Parking Distance Warning does not warn you in the order of detection. It varies depending on the speed of the vehicle or the shape of a person, animal, or object.**
- **If the Parking Distance Warning does not operate properly, have the vehicle inspected by an authorized HYUNDAI dealer.**

## FORWARD/REVERSE PARKING DISTANCE WARNING (PDW) (IF EQUIPPED)

Forward/Reverse Parking Distance Warning can help warn the driver if an obstacle is detected within a certain distance when the vehicle is moving forward or in reverse at low speeds.

### Detecting sensor

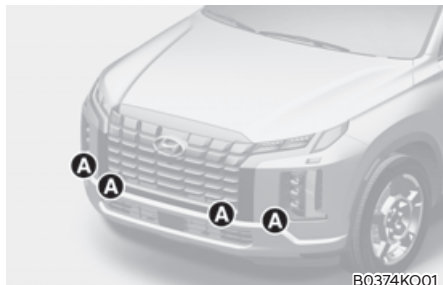

B0374KO01

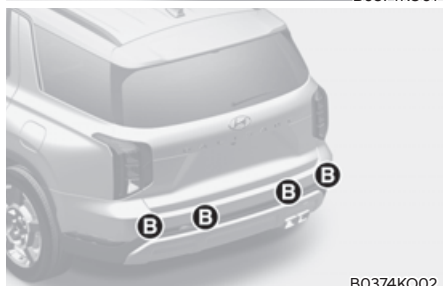

B0374KO02

- Ⓐ: Front ultrasonic sensors,
- Ⓑ: Rear ultrasonic sensors

Refer to the picture above for the detailed location of the detecting sensors.

## Forward/Reverse Parking Distance Warning Settings

### Warning Volume

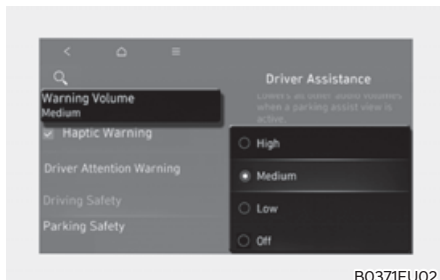

B0371EU02

Select 'Driver Assistance → Warning Volume' from the Settings menu to change the Warning Volume to 'High', 'Medium', 'Low' or 'Off' for Parking Distance Warning.

### **i** Information

- If 'Off' is selected, the Warning Volume of Parking Distance Warning will not turn off, but the volume will sound as 'Low'.
- If you change the Warning Volume, the Warning Volume of other Driver Assistance systems may change.

### **Parking Distance Warning Auto On**

To use Parking Distance Warning Auto On function, select 'Driver Assistance → Parking Safety → Parking Distance Warning Auto On' from the cluster or infotainment system Settings menu.

### **i** Information

When Parking Distance Warning Auto On is selected, the Parking Safety button indicator (P<sup>W</sup>) stays on.

## Forward/Reverse Parking Distance Warning Operation

### Parking Safety button

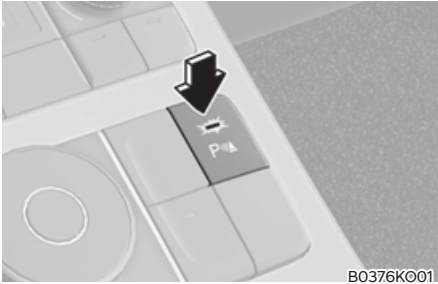

- Press the Parking Safety (PWA) button to turn on Forward/Reverse Parking Distance Warning. Press the button again to turn off the function.
- When Forward/Reverse Parking Distance Warning is off (button indicator light off), if you shift the gear to R (Reverse), Forward/Reverse Parking Distance Warning will automatically turn on.
- When Forward/Reverse Parking Distance Warning turns on, the button indicator light will turn on. If vehicle speed is above 18 mph (30 km/h), Forward/Reverse Parking Distance Warning will turn off (button indicator light off).

### Forward Parking Distance Warning



Forward Parking Distance Warning will operate when one of the condition is satisfied.

- The gear is shifted from R (Reverse) to D (Drive) with Reverse Parking Distance Warning on
- The gear is in D (Drive) and the Parking Safety button indicator light is on
- 'Parking Distance Warning Auto On' is selected from the Settings menu and the gear is in D (Drive)

### Information

- **Forward Parking Distance Warning does not operate when the vehicle's forward speed is above 10 km/h even when the Parking Safety (PWA) button indicator is on. Forward Parking Distance Warning will operate again when the vehicle's forward speed decreases below 10 km/h while the Parking Safety (PWA) button indicator is on.**
- **Forward Parking Distance Warning is deactivated if the vehicle speed reaches above 30 km/h. It will not reactivate although the vehicle speed drops below 10km/h. (Only when Parking Warning Auto On is not selected)**

- When 'Parking Distance Warning Auto On' is deselected, and the vehicle's forward speed is above 18 mph (30 km/h), the Parking Safety button indicator will turn off. Although you drive below 6 mph (10 km/h), Forward Parking Distance Warning will not turn on.

Distance from object	Warning indicator when driving forward	Warning sound
24–40 in. (60–100 cm)		Buzzer beeps intermittently
12–24 in. (30–60 cm)		Beeps more frequently
within 12 in. (30 cm)		Beeps continuously

- The corresponding indicator will illuminate whenever each ultrasonic sensor detects a person, animal or object in its sensing range. Also an audible warning will sound.
- When more than two objects are detected at the same time, the closest one will be warned with an audible warning.
- The shape of the indicator in the illustration may differ from the actual vehicle.



### Reverse Parking Distance Warning

Reverse Parking Distance Warning will operate under the following conditions.

- The gear is shifted to R (Reverse).
- Vehicle speed is below 6 mph (10 km/h).

### Information

**Parking Distance Warning detects and warns the driver of both rear and front corners, when the vehicle speed is below 6 mph (10 km/h).**

Distance from object	Warning indicator when driving backward	Warning sound
24–48 in. (60–120 cm)		Buzzer beeps intermittently
12–24 in. (30–60 cm)		Beeps more frequently
within 12 in. (30 cm)		Beeps continuously

- The corresponding indicator will illuminate whenever each ultrasonic sensor detects a person, animal or object in its sensing range. Also an audible warning will sound.
- When more than two objects are detected at the same time, the closest one will be warned with an audible warning.
- The shape of the indicator in the illustration may differ from the actual vehicle.

## Forward/Reverse Parking Distance Warning Malfunction and Precautions

### Parking Distance Warning malfunction

After starting the engine, a beep will sound when the gear is shifted to R (Reverse) to indicate Parking Distance Warning is operating properly.

However, if one or more of the following occurs, first check whether the ultrasonic sensor is damaged or blocked with foreign material. If it still does not work properly, have the vehicle inspected by an authorized HYUNDAI dealer.

- The audible warning does not sound.
- The buzzer sounds intermittently.
- The 'Ultrasonic sensor error or blockage' warning message appears on the cluster.

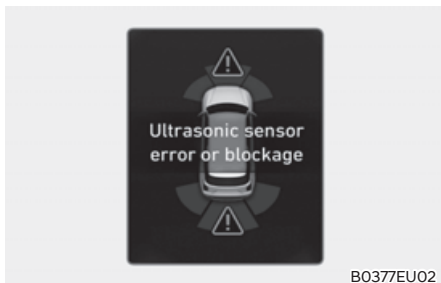
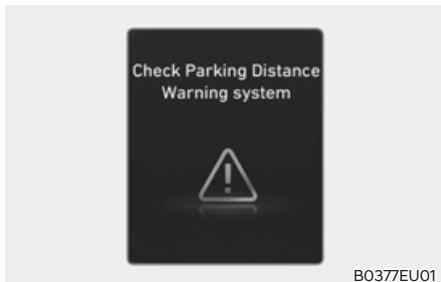

### Parking Distance Warning disabled



If this occurs the 'Parking Distance Warning system limited. Ultrasonic sensor blocked' warning message appears on the cluster. Parking Distance Warning will operate properly when snow, rain or foreign material is removed.

If Parking Distance Warning does not operate properly after obstruction (snow, rain, or foreign material) is removed (including trailer, carrier, etc., from the rear bumper), have the vehicle inspected by an authorized HYUNDAI dealer.



### **Limitations of Forward/Reverse Parking Distance Warning**

- Parking Distance Warning may not operate properly when:
  - Moisture is frozen to the sensor
  - Sensor is covered with substance, such as snow or water (Forward/Reverse Parking Distance Warning will operate properly when such substance is removed.)
  - The weather is extremely hot or cold
  - The sensor or sensor assembly is disassembled
  - The surface of the sensor is pressed hard or hit with a hard object
  - The surface of the sensor is scratched with a sharp object
  - The sensors or its surrounding area is directly sprayed with high pressure washer
- Parking Distance Warning may malfunction when:
  - Heavy rain or water spray is present
  - Water flows on the surface of the sensor
  - Affected by another vehicle's sensors
  - The sensor is covered with snow or ice
  - Driving on uneven road, gravel roads or bushes
  - Objects that generates ultrasonic waves are near the sensor
  - License plate is installed in a different spot from the original location
  - The vehicle bumper height or ultrasonic sensor installation has been modified
  - Attaching equipment or accessories next to the ultrasonic sensors
- The following objects may not be detected:
  - Sharp or slim objects, such as ropes, chains or small poles.
  - Narrow objects, such as corners of a square column
  - Objects, which tend to absorb sensor frequency, such as clothes, spongy material or snow.
  - Objects smaller than 40 in. (100 cm) in length and narrower than 6 in. (14 cm) in diameter.
  - Pedestrians, animals or objects that are very close to the ultrasonic sensors



### **WARNING**

- **Parking Distance Warning is a supplemental function. The operation of Parking Distance Warning can be affected by several factors (including environmental conditions). It is the responsibility of the driver to always check the front and rear views before and while parking.**
- **Your new vehicle warranty does not cover any accidents or damage to the vehicle due to the malfunction of Parking Distance Warning.**
- **Pay close attention when driving near objects, pedestrians, and especially children. Some objects may not be detected by the ultrasonic sensors, due to the objects distance, size or material, all of which can limit the effectiveness of the sensor.**
- **Parking Distance Warning does not warn you in the order of detection. It varies depending on the speed of the vehicle or the shape of a person, animal, or object.**
- **If the Parking Distance Warning does not operate properly, have the vehicle inspected by an authorized HYUNDAI dealer.**

## REVERSE PARKING COLLISION-AVOIDANCE ASSIST (PCA) (IF EQUIPPED)

Reverse Parking Collision-Avoidance Assist can warn the driver or assist with braking to help reduce the possibility of collision with a pedestrian or an object while driving at low speed.

### Detecting sensor

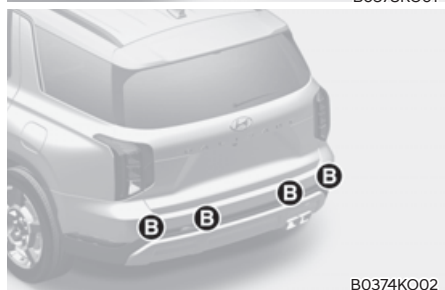

- (A): Wide-rear view camera,
- (B): Rear ultrasonic sensors

Refer to the picture above for the detailed location of the detecting sensors.

## Reverse Parking Collision-Avoidance Assist Settings

### Parking Safety

With the engine on, select or deselect 'Driver Assistance → Parking Safety' from the Settings menu to set whether to use each function.

- If 'Rear Safety' is selected, Parking Collision-Avoidance Assist will warn the driver and assist with braking when a collision with a pedestrian or an object is imminent from behind.

### Warning Volume

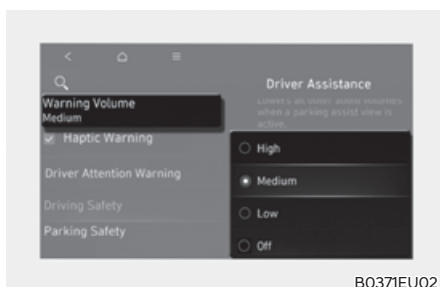

With the engine on, select 'Driver Assistance → Warning Volume' from the Settings menu to change the Warning Volume to 'High', 'Medium', 'Low' or 'Off' for Reverse Parking Collision-Avoidance Assist.

### **i** Information

- If 'Off' is selected, the Warning Volume of Parking Collision-Avoidance Assist will not turn off, but the volume will sound as 'Low'.
- If you change the Warning Volume, the Warning Volume of other Driver Assistance systems may change.

## Reverse Parking Collision-Avoidance Assist Operation

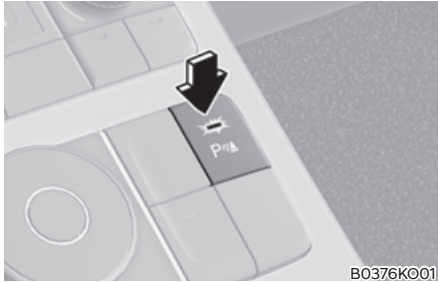

### Turning Parking Collision Avoidance Assist On/Off

Press and hold the Parking Safety (P $\triangle$ ) button more than 2 seconds, 'Rear Active Assist' or to turn the Parking Collision-Avoidance Assist on or off.

### Operating conditions

If Reverse Parking Collision-Avoidance Assist detects a risk of collision behind the vehicle with a pedestrian or an object, Reverse Parking Collision-Avoidance Assist will warn the driver with an audible warning and warning message on the cluster. If Surround View Monitor is operating, a warning will appear on the infotainment screen.

If collision is imminent, Reverse Parking Collision-Avoidance Assist will assist you with braking.

Select 'Rear Safety' from the 'Parking Safety' menu of the infotainment system. Parking Collision-Avoidance Assist is enabled when the following conditions are satisfied:

- The liftgate and door are closed
- The Electronic Parking Brake (EPB) is released
- A trailer is not connected
- The gear is shifted to R (Reverse)
- Vehicle speed is below 6 mph (10 km/h) (detecting pedestrians)
- Vehicle speed is below 2.4 mph (4 km/h) (detecting objects)
- Parking Collision-Avoidance Assist components such as the rear view camera and the rear ultrasonic sensors are in normal conditions

When Reverse Parking Collision-Avoidance Assist activates, a line appears behind the vehicle image in the instrument cluster.



### **i** Information

**Reverse Parking Collision-Avoidance Assist operates only once after shifting the gear to R (Reverse). To reactivate Parking Collision-Avoidance Assist, shift the gear from another gear to R (Reverse).**

#### **Off conditions**

If collision is imminent, Reverse Parking Collision-Avoidance Assist will assist you with braking. Braking assist is released after 5 minutes. Immediately depress the brake pedal and check vehicle surroundings. Braking assist is also released in the following conditions when:

- The gear is shifted to P (Park) or D (Drive)
- The brake pedal is depressed with sufficient power

### **i** Information

**When Parking Collision-Avoidance Assist is activated while reversing, braking control will be released after 5 minutes and the Electronic Parking Brake (EPB) will be engaged.**

## **Reverse Parking Collision-Avoidance Assist Malfunction and Limitations**

### **Reverse Parking Collision-Avoidance Assist malfunction**

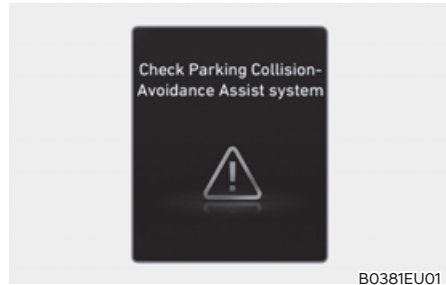

When Reverse Parking Collision-Avoidance Assist or other related functions are not working properly, the 'Check Parking Collision-Avoidance Assist system' warning message will appear on the cluster, and Reverse Parking Collision-Avoidance Assist will turn off automatically. Have the vehicle inspected by an authorized HYUNDAI dealer.

## Reverse Parking Collision-Avoidance Assist disabled

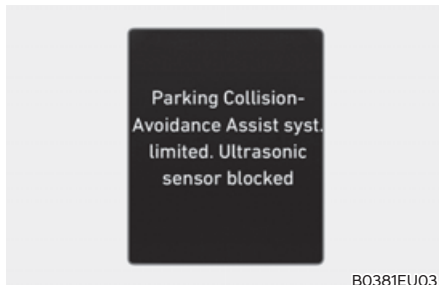
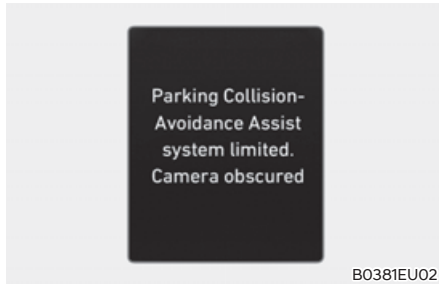

The 'Parking Collision-Avoidance Assist system limited. Camera obscured' or 'Parking Collision-Avoidance Assist syst. limited. Ultrasonic sensor blocked' warning message will appear on the cluster if the following situations occur:

- The rear view camera or rear ultrasonic sensor(s) is covered with foreign material, such as snow or rain, etc.
- There is inclement weather, such as heavy snow, heavy rain, etc.

If this occurs, Reverse Parking Collision-Avoidance Assist may turn off or may not operate properly. Check whether the rear view camera and rear ultrasonic sensors are clean.

## Limitations of Reverse Parking Collision-Avoidance Assist

Reverse Parking Collision-Avoidance Assist may not assist braking or warn the driver even if there are pedestrians or objects under the following circumstances:

- Problems with vehicle
  - Any non-factory equipment or accessory is installed
  - Your vehicle is unstable due to an accident or other causes
  - Bumper height or rear ultrasonic sensor installation has been modified
  - Wide-rear view camera(s) or rear ultrasonic sensor(s) is damaged
  - Wide-rear view camera(s) or the rear ultrasonic sensor(s) is stained with foreign material, such as snow, dirt, etc.
  - Wide-rear view camera(s) is obscured by a light source or by inclement weather, such as heavy rain, fog, snow, etc.
- Problems with the surroundings
  - The surrounding is very bright or very dark
  - Outside temperature is very high or very low
  - The wind is either strong (above 12 mph (20 km/h)) or blowing perpendicular to the rear bumper
  - Objects generating excessive noise, such as vehicle horns, loud motorcycle engines or truck air brakes, are near your vehicle
  - An ultrasonic sensor with similar frequency is near your vehicle
  - The road is slippery or inclined
  - The image of the pedestrian in the rear view camera is indistinguishable from the background

- Problems with pedestrian or object
  - The pedestrians are difficult to detect- There is ground height difference between the vehicle and the pedestrian
  - The pedestrian is near the rear edge of the vehicle
- The pedestrian is not standing upright
- The pedestrian is either very short or very tall to detect
- The pedestrian or cyclist is wearing clothing that easily blends into the background, making it difficult to detect
  - The pedestrian is wearing clothing that does not reflect ultrasonic waves well
  - Size, thickness, height, or shape of the object does not reflect ultrasonic waves well (for example, pole, bush, curbs, carts, edge of a wall, etc.)
  - The pedestrian or the object is moving
  - The pedestrian or the object is very close to the rear of the vehicle
  - A wall is behind the pedestrian or the object
  - The object is not located at the rear center of your vehicle
  - The object is not parallel to the rear bumper
  - The driver drives the vehicle immediately after shifting to R (Reverse) or D (Drive)
  - The driver accelerates or circles the vehicle
  - The vehicle is driven immediately after starting the vehicle

Reverse Parking Collision-Avoidance Assist may unnecessarily warn the driver or assist with braking even if there are no pedestrians or objects under the following circumstances:

- Any non-factory equipment or accessory is installed
- Your vehicle is unstable due to an accident or other causes
- Bumper height or rear ultrasonic sensor installation has been modified
- Your vehicle height is low or high due to heavy loads, abnormal tire pressure, etc.
- Rear wide angle camera or the rear ultrasonic sensor(s) is stained with foreign material, such as snow, dirt, etc.
- The pattern on the road is mistaken for a pedestrian
- There is shadow or light reflecting on the ground
- Objects generating excessive noise, such as vehicle horns, loud motorcycle engines or truck air brakes, are near your vehicle
- Your vehicle is backing towards a narrow passage or parking space
- Your vehicle is backing towards an uneven road surface, such as an unpaved road, gravel, bump, gradient, etc.
- A trailer or carrier is installed on the rear of your vehicle
- An ultrasonic sensor with similar frequency is near your vehicle
- The pedestrian or the object is moving
- The driver accelerates or circles the vehicle
- The vehicle moves forward and backward repeatedly

**WARNING**

Take the following precautions when using Reverse Parking Collision-Avoidance Assist:

- Always exercise extreme caution while driving. The driver is responsible for controlling the brake for safe driving.
- Always pay attention to road and traffic conditions while driving, whether or not there is a warning.
- Always look around your vehicle to make sure there are no pedestrians or objects before moving the vehicle.
- The performance of Reverse Parking Collision-Avoidance Assist may vary under certain conditions. If vehicle speed is above 2 mph (4 km/h), Reverse Parking Collision-Avoidance Assist will provide collision avoidance assist only when pedestrians are detected. Always look around and pay attention when backing up your vehicle.
- Reverse Parking Collision-Avoidance Assist may operate differently under certain conditions. If the vehicle moves forward and backward repeatedly, Reverse Parking Collision-Avoidance Assist may fail to assist braking or to warn the driver. Always pay attention when driving your vehicle.
- Some objects may not be detected by the rear ultrasonic sensors due to the objects distance, size or material, all of which can limit the effectiveness of the sensor.
- Reverse Parking Collision-Avoidance Assist may not operate properly or may operate unnecessarily depending on the road conditions and the surroundings.
- Do not solely rely on Reverse Parking Collision-Avoidance Assist. Doing so may lead to vehicle damage or injuries.
- Noise may be heard when sudden braking occurs to avoid a collision.
- If any other warning sound such as the seat belt warning chime is already generated, Reverse Parking Collision-Avoidance Assist warning may not sound.
- Reverse Parking Collision-Avoidance Assist may not work properly if the bumper has been damaged, replaced or repaired.
- Reverse Parking Collision-Avoidance Assist may not operate properly if interfered by strong electromagnetic waves.
- Playing the vehicle audio system at high volume may prevent passengers from hearing Reverse Parking Collision-Avoidance Assist warning sounds.
- Turn off Parking Collision-Avoidance Assist when towing a trailer. If towing and moving in reverse, Parking Collision-Avoidance Assist will activate as it detects the trailer.
- The brake control may not operate properly depending on the status of ESC (Electronic Stability Control). There will only be a warning when:
  - The ESC (Electronic Stability Control) warning light is on
  - ESC (Electronic Stability Control) is engaged in a different function



## CAUTION

Take the following precautions to maintain optimal performance of the detecting sensors:

- Always keep the wide-rear view cameras and ultrasonic sensors clean.
- Do not use any cleanser containing acid or alkaline detergents when cleaning the camera lens. Use only a mild soap or neutral detergent, and rinse thoroughly with water.
- Do not spray the wide-rear view cameras or the rear ultrasonic sensors or their surrounding area directly with a high pressure washer. It may cause the wide angle cameras or the ultrasonic sensors to malfunction.
- Do not apply objects, such as a bumper sticker or a bumper guard, near the wide angle cameras or ultrasonic sensors or apply paint to the bumper. Doing so may adversely affect the performance of Parking Collision-Avoidance Assist.
- Never disassemble or apply impact on the wide angle cameras or the ultrasonic sensors components.
- Do not apply unnecessary force on the wide-rear view cameras or the ultrasonic sensors. Reverse Parking Collision-Avoidance Assist may not operate properly if the wide angle cameras or the ultrasonic sensor(s) is forcibly moved out of proper alignment. Have the vehicle inspected by an authorized HYUNDAI dealer.



## Information

Reverse Parking Collision-Avoidance Assist can detect a pedestrian or an object when:

- A pedestrian is standing behind the vehicle
- A large obstacle, such as a vehicle, is parked in the rear center of your vehicle



## REMOTE SMART PARKING ASSIST (RSPA) (IF EQUIPPED)

Remote Smart Parking Assist uses vehicle sensors to help the driver park and exit parking spaces remotely from outside the vehicle by controlling the steering wheel, vehicle speed, and gearshifts.

Function	Description
Remote Operation	<p>Remotely moving forward or backward</p>  <p>B0382KO01</p>

- Remote Smart Parking and Remote Operation function may be operated from outside the vehicle using the smart key.
- When Remote Smart Parking Assist operates, Parking Distance Warning and Surround View Monitor will also operate. For more details, refer to “Parking Distance Warning (PDW)” and “Surround View Monitor (SVM)” sections in this chapter.

### Detecting sensors

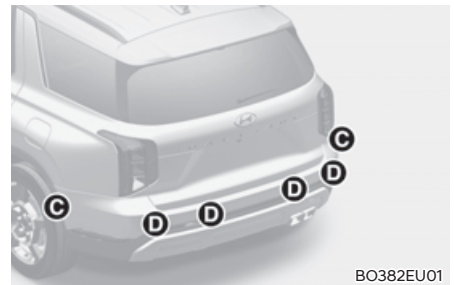
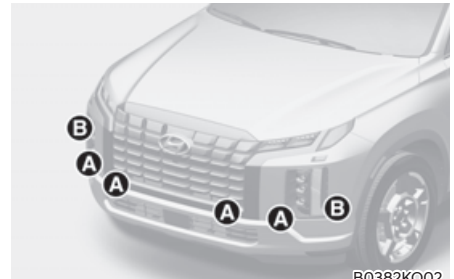

- Ⓐ: Front ultrasonic sensors,
- Ⓑ: Front corner ultrasonic sensors,
- Ⓒ: Rear corner ultrasonic sensors,
- Ⓓ: Rear ultrasonic sensors

Refer to the picture above for the detailed location of the detecting sensors.

### CAUTION

Take the following precautions to maintain optimal performance of the detecting sensors:

- Never disassemble the detecting sensor or sensor assembly, or cause any damage to it.
- If the detecting sensors need repair, have the vehicle inspected by an authorized HYUNDAI dealer.

- **Remote Smart Parking Assist may malfunction if the vehicle bumper height or ultrasonic sensor installation has been modified or damaged. Any non-factory installed equipment or accessories may also interfere with the sensor performance.**
- **When the ultrasonic sensor is frozen or stained with snow, dirt, or water, the sensor may not operate until the stains are removed using a soft cloth.**
- **Do not push, scratch, or strike the ultrasonic sensor. Sensor damage could occur.**
- **Do not spray the ultrasonic sensors or its surrounding area directly with a high pressure washer.**

## Remote Smart Parking Assist Settings

### Warning Volume

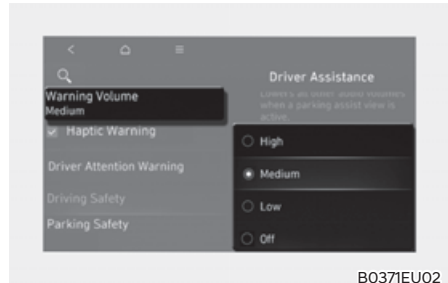

With the engine on, select 'Driver Assistance → Warning Volume' from the Settings menu to change the Warning Volume to 'High', 'Medium', 'Low' or 'Off' for Remote Smart Parking Assist.







### WARNING

- **If 'Off' is selected, the Warning Volume of Remote Smart Parking Assist will not turn off**
- **If you change the Warning volume, the Warning volume of other Driver Assistance systems may change.**

## Remote Smart Parking Assist Operation

### Remote Smart Parking Assist button

Parking/View button	Parking Safety button	Smart key
		
B0384KO01	B0376KO01	B0384KO02

Location	Name	Symbol	Description
Inside vehicle	Parking/View button		<ul style="list-style-type: none"> <li>Press and hold the Parking/View button to turn on Remote Smart Parking Assist. Also, Forward/Reverse Parking Distance warning will automatically turn on.</li> </ul>
	Parking Safety button		<ul style="list-style-type: none"> <li>Press the Parking Safety button while Remote Smart Parking Assist is operating to end Remote Smart Parking Assist operation.</li> </ul>
Smart key	Remote Start button		<ul style="list-style-type: none"> <li>Press the Remote Start button after the door is locked with the engine off to start the engine remotely.</li> <li>Press the Remote Start button while Remote Smart Parking or Remote Operation function is operating to end function operation.</li> </ul>
	Forward button		<ul style="list-style-type: none"> <li>When using the Remote Operation function, the vehicle moves in the direction of the button while the button is pressed.</li> </ul>
	Backward button		

## Remote Operation

### Operating order

Remote Operation operates in the following order:

1. Getting ready to remotely move forward and backward
2. Remotely moving forward and backward

### 1. Getting ready to remotely move forward and backward

There are two ways to operate Remote Operation function.

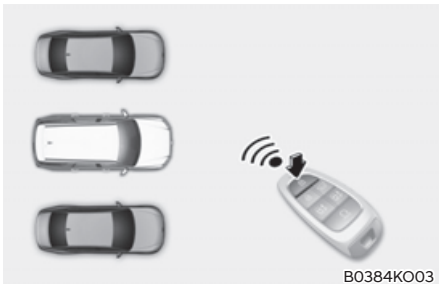

Method (1) Using the function with engine off

- (1) Within a certain range from the vehicle press the door lock (🔒) button on the smart key and lock all doors.
- (2) Press and hold the Remote Start button (🔌) within 4 seconds until the engine starts.
  - For more details on remotely starting the engine, refer to “Remote Start” section in chapter 6.



Method (2) Using the function with engine on

- (1) Park the vehicle in front of the space where you want to use Remote Operation function, and shift the gear to P (Park).
- (2) Press and hold the Parking/View (Ⓟ) button to turn on Smart Parking Assist. A message ‘Under Remote Control’ will appear on the infotainment system screen.
- (3) Get out of the vehicle with the smart key and close all doors.

### **i** Information

**'Agree' must be selected on the infotainment system screen and the infotainment system has to operate properly to use Remote Operation function.**

## 2. Remotely moving forward and backward

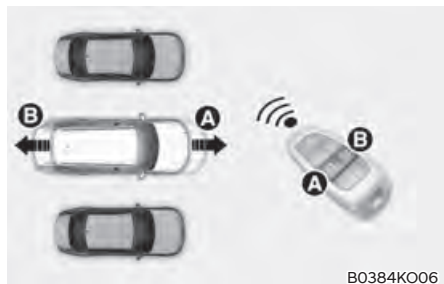

- (1) Press and hold one of the Forward (A) or Backward (B) button on the smart key.
  - Remote Smart Parking Assist will automatically control the steering wheel, vehicle speed and gearshift. The vehicle will move in the direction of the button pressed.
  - While Remote Operation function is operating, if you let the button, the vehicle will stop and function control will pause. The function will start operating again when the button is pressed and held again.
- (2) Hold down the Forward (A) or Backward (B) button until the vehicle reaches the target location.
- (3) When Remote Operation is done, get in the vehicle with the smart key or press the Remote Start (HOLD) button on the smart key from outside the vehicle.
  - The message will appear on the infotainment system screen. The vehicle will automatically shift to P (Park) and engage the parking brake.
  - When the Remote Start (HOLD) button is pressed, the vehicle will turn off. If the driver is in the vehicle, the vehicle will retain ON position.

## **i** Information

- Remote Operation can control the vehicle remotely using the smart key outside the vehicle.
- Check that all smart keys are outside the vehicle when using Remote Operation function.
- Remote Operation function will operate only when the smart key is within 13 ft. (4 m) from the vehicle. If there is no vehicle movement even when the Forward or Backward button is pressed on the smart key, check the distance to the vehicle and press the button again.
- The detecting range of the smart key may vary depending on the surroundings that are affected by radio waves such as transmission tower, broadcast station, etc.
- When remotely moving forward using method (1), it is recognized as an exit situation, and the vehicle moves 13 ft. (4 m) to check for pedestrians, animals or objects around the vehicle. After confirmation, the steering wheel is controlled according to the condition ahead.
- When remotely moving forward using method (2), it is recognized as a parking situation, and will immediately control the steering wheel according to the condition ahead to assist with entering the parking space and aligning the vehicle. However, performance may reduce depending on the pedestrians, animals, shape of objects, location, etc., around the vehicle.
- For moving remotely backward, both method (1) and (2) aligns the steering wheel first, and then will only move the vehicle straight.

 **WARNING**

- When using Remote Operation function, make sure that all passengers have gotten out of the vehicle.
- If the vehicle's battery is discharged or Remote Smart Parking Assist malfunctions when parked in a narrow parking space, Remote Operation function will not operate. Always park your vehicle in a space wide enough for you to get in or out of your vehicle.
- Please note that depending on the parking space, you may not be able to exit from the space you have entered by using Remote Operation function.
- After parking, the surrounding may change due to the movement of surrounding vehicles. If this occurs, Remote Operation function may not operate.
- Before leaving the vehicle, close windows and sunroofs, and make sure the engine is off before locking the doors.

Remote Operation function operation status

Operation status	Smart key LED	Hazard warning light
Under control	Green LED continuously blinks	-
Pause	Red LED continuously blinks	Blinks
Off	Red LED illuminates for 4 seconds and then turns off	Blinks 3 times and turns off
Complete	Green LED illuminates for 4 seconds and then turns off	Blinks 1 time and turns off

 **Information**

- Operation status by the hazard warning light may not be applicable based on the regulation of your country.
- If the smart key is not within the operating range from the vehicle (approximately 13 ft. (4m)), the smart key LED will not illuminate or blink. Use the smart key within the operating range.

### How to turn off Remote Operation function while operating

- Press the Parking/View (P/V) button while the infotainment system screen guides the driver using method 2.
- Shift the gear from P (Park) to any other position while the infotainment system screen guides the driver using method 2.
- Press the Parking Safety (P/A) button or select 'Cancel' on the infotainment system screen.
- Press the Remote Start (R/O) button on the smart key while the vehicle is being controlled by Remote Operation function. Remote Operation function will turn off. At this time, the engine will turn off.
- Get on the vehicle with the smart key. Remote Operation function will turn off. At this time, the engine will remain on.

### The function will pause in the following conditions when:

- There is a pedestrian, animal or object in the direction the vehicle is moving
- The door or liftgate is open
- The Forward (F/P) or Backward (B/P) button is not continuously pressed
- Simultaneously pressing multiple buttons on a smart key
- The smart key is not operated within 13 ft. (4 m) from the vehicle
- Button of another smart key is pressed in addition to the operating smart key
- Blind-Spot Collision Warning or Rear Cross-Traffic Collision-Avoidance Assist operates while the vehicle is being controlled in the reverse direction.
- The vehicle moves 22 ft. (7 m) while the smart key is pressed with Remote Operation function (maximum travel distance per button press)

### The function will cancel in the following conditions when:

When Remote Operation function is canceled, the vehicle will automatically stop, shift the gear to P (Park) and engage EPB (Electronic Parking Brake).

- The steering wheel is steered
- The gear is shifted while the vehicle is moving
- Operating EPB while the vehicle is moving
- The engine hood is open
- The brake pedal or accelerator pedal is depressed when all the doors are closed
- The smart key is outside the vehicle when the brake pedal is depressed while the driver's door is open
- Rapid acceleration occurs
- Vehicle skid occurs
- The wheel is stuck by an obstacle and cannot move
- Approximately 3 minutes and 50 seconds has passed after Remote Operation function has started to operate
- The slope of the road exceeds the operational range
- The function is paused for more than 1 minute
- The total travel distance of the vehicle has exceeded 45 ft. (14 m) after Remote Operation function operation
- The steering wheel, gearshift, braking, and drive controls are not working properly
- There is a problem with the smart key or the smart key battery is low
- ABS, TCS or ESC system operates due to slippery road conditions
- The alarm of the Theft Alarm System sounds

## Remote Smart Parking Assist Malfunction and Limitations

### Remote Smart Parking Assist malfunction

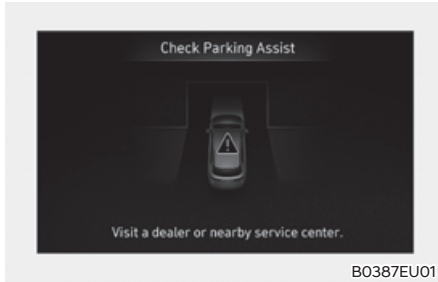

#### Remote Smart Parking Assist check

When Remote Smart Parking Assist is not working properly, the 'Check Parking Assist' warning message will appear on the infotainment system screen. If the message appears, stop using Remote Smart Parking Assist, and have the vehicle inspected by an authorized HYUNDAI dealer.

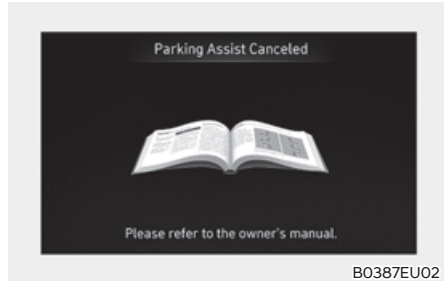

#### Remote Smart Parking Assist canceled

When Remote Parking Assist is operating, the function can be canceled, and the 'Parking Assist Canceled' warning message may appear regardless of the parking order. Other messages may appear depending on the situations. Follow the instructions provided on the infotainment system screen while parking your vehicle with Remote Parking Assist. Always look around and pay attention when using Remote Smart Parking Assist.

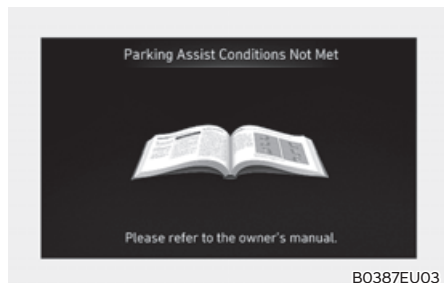

#### Remote Smart Parking Assist standby

'Parking Assist Conditions Not Met' message appears when Parking/View (⏏) button has been pressed and held while Remote Smart Parking Assist is in standby.

After a while, press and hold the Parking/View (⏏) button again to see if Remote Smart Parking Assist works.

The message appears even when the smart key's battery is low. Check the smart key battery level.



### ***Limitations of Remote Smart Parking Assist***

In the following circumstances, Remote Smart Parking Assist performance to park or exit the vehicle may be limited, there may be a risk of collision, or Remote Smart Parking Assist may turn off. Park or exit the vehicle manually if necessary.

- An object is attached to the steering wheel
- The vehicle is installed with a snow chain, spare tire or different size wheel
- Tire pressure is lower or higher than the standard tire pressure
- Your vehicle is loaded with cargo longer or wider than your vehicle or a trailer is connected to your vehicle
- There is a problem with the wheel alignment
- Your vehicle is leaned severely to one side
- Your vehicle is equipped with a trailer hitch
- The license plate is installed differently from the original location
- There is a person, animal or object above or below the ultrasonic sensor when Remote Smart Parking Assist is activated
- The parking space is curved or diagonal
- There is an obstacle such as a person, animal or object (trash can, bicycle, motorcycle, shopping cart, narrow pillar, etc.) near the parking space
- There is a circular pillar or narrow pillar, or a pillar surrounded by objects such as fire extinguisher, etc., near the parking space
- The road surface is bumpy (curbstone, speed bump, etc.)
- The road is slippery
- The parking space is near a vehicle with higher ground clearance or big, such as a truck, etc.
- The parking space is Inclined
- There is heavy wind
- Operating Remote Smart Parking Assist on uneven roads, gravel roads, bushes, etc.
- The performance of the ultrasonic sensor is affected by extremely hot or cold weather
- The ultrasonic sensor is covered with snow or water
- An object that generates ultrasonic waves is nearby
- A wireless device with a transmission function operates near the ultrasonic sensors
- Your vehicle is affected by another vehicle's Parking Distance Warning
- The sensor is mounted or positioned incorrectly by an impact to the bumper
- When the ultrasonic sensor cannot detect the following objects:
  - Sharp or slim objects, such as ropes, chains or small poles
  - Objects smaller than 40 in. (100 cm) in length and narrower than 6 in. (14 cm) in diameter
  - Objects which tend to absorb sensor frequency, such as clothes, spongy material or snow
  - A narrow object such as a corner of a square pillar
  - Person, animal or object near the ultrasonic sensor

Remote Smart Parking Assist may not operate properly under the following circumstances:

- Parking on inclines



Park manually when parking on inclines.

- Parking on uneven road



Remote Smart Parking Assist may cancel when the vehicle slips, or the vehicle cannot move due to road conditions such as pebbles or fragmented stones.

- Parking behind a truck



Do not use Remote Smart Parking Assist around vehicles with higher ground clearance, such as a bus, truck, etc. It may lead to an accident.

- Parking near a pillar

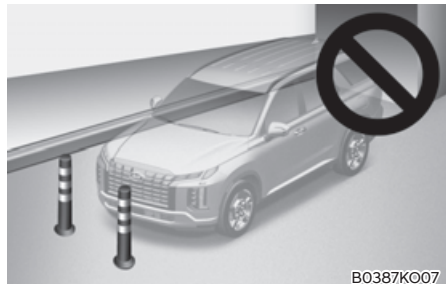

Remote Smart Parking Assist performance may reduce or collision with an obstacle may occur when there is a narrow object, circular pillar, square pillar, or a pillar surrounded by objects such as a fire extinguisher, etc., near the parking space. The driver should park the vehicle manually.

- Parking in a parking space with a vehicle on one side only

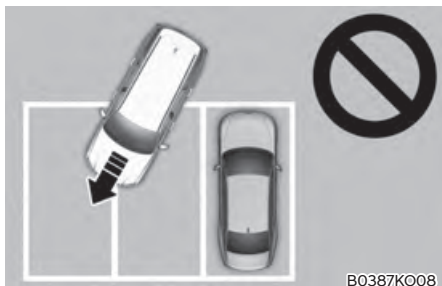

If Remote Smart Parking Assist is used, when parking in a parking space with a vehicle only on one side, your vehicle may cross the parking line to avoid the parked vehicle.

- Parking diagonal



Remote Operation may not operate properly in a diagonal parking space.

- Parking in snow



Snow may interfere with sensor operation, or Remote Smart Parking Assist may cancel if the road is slippery while parking.

### WARNING

Take the following precautions when using Remote Smart Parking Assist:

- The driver is responsible for safe parking and exit when using Remote Smart Parking Assist.
- When using Remote Smart Parking Assist, stay out of the way in the direction the vehicle moves for your safety.
- Always check surroundings when using Remote Smart Parking Assist. You may collide with pedestrians, animals, or objects if they are near the sensor or are in the sensor's blind spot area.
- A collision may occur if a pedestrian, animal, or object suddenly appears while Remote Smart Parking Assist is operating.
- Do not use Remote Smart Parking Assist when under the influence of alcohol.
- Do not let children or other people to use the smart key.
- If Remote Smart Parking Assist is used continuously for a long period, it may adversely affect Remote Smart Parking Assist performance.

- Remote Smart Parking Assist may not operate properly if the vehicle needs wheel alignment adjustment such as when the vehicle tilts to one side. Have the vehicle inspected by an authorized HYUNDAI dealer.
- Noise may be heard when braking occurs by Remote Smart Parking Assist or when the brake pedal is depressed by the driver.
- Remote Smart Parking Assist may suddenly apply the brake to avoid collision.
- Use Remote Smart Parking Assist only in a parking space that is large enough for the vehicle to move safely.

### **NOTICE**

- If the 3rd stage warning (continuous beep) of the Forward/Reverse Parking Distance Warning sounds while Remote Smart Parking Assist is operating, it means the obstacle detected is close to your vehicle. At this time, Remote Smart Parking Assist will temporarily stop operating. Make sure there are no pedestrians, animals, or objects around your vehicle.
- Depending on brake operation, the stop lights may come on while the vehicle is moving.
- If the vehicle is remotely started that has been parked in cold weather for a long time, the operation of Remote Smart Parking function may be delayed or canceled depending on vehicle condition.

## DECLARATION OF CONFORMITY (IF EQUIPPED)

### Front Radar

The radio frequency components complies:

- For USA



FCC ID  
: 2ACDX-MRR-30  
This device complies with Part 15 of the FCC Rules. Operation is subject to the following two conditions:  
(1) this device may not cause harmful interference, and  
(2) this device must accept any interference received, including interference that may cause undesired operation.

**CAUTION TO USERS**  
Changes or modifications not expressly approved by the party responsible for compliance could void the user's authority to operate the equipment.

OANATEL342

- For Canada

Model: MRR-30  
IC: 11988A-MRR30

This device complies with Industry Canada licence-exempt RSS standard(s). Operation is subject to the following two conditions:  
(1) this device may not cause interference, and  
(2) this device must accept any interference, including interference that may cause undesired operation of the device.

Le présent appareil est conforme aux CNR d'Industrie Canada applicables aux appareils radio exempts de licence. L'exploitation est autorisée aux deux conditions suivantes:  
(1) l'appareil ne doit pas produire de brouillage, et  
(2) l'utilisateur de l'appareil doit accepter tout brouillage radioélectrique subi, même si le brouillage est susceptible d'en compromettre le fonctionnement.

OANATEL343

## Front Corner Radar/Rear Corner Radar

The radio frequency components complies:

- For USA



FCC ID : LTQH5TR

This device complies with Part 15 of the FCC Rules. Operation is subject to the following two conditions:  
(1) this device may not cause harmful interference, and  
(2) this device must accept any interference received, including interference that may cause undesired operation.

**CAUTION TO USERS**  
Changes or modifications not expressly approved by the party responsible for compliance could void the user's authority to operate the equipment.

OANATEL352

- For Canada

Model: H5TR  
IC: 3659A-H5TR

This device complies with Industry Canada licence-exempt RSS standard(s). Operation is subject to the following two conditions:  
(1) this device may not cause interference, and  
(2) this device must accept any interference, including interference that may cause undesired operation of the device.

Le présent appareil est conforme aux CNR d'Industrie Canada applicables aux appareils radio exempts de licence. L'exploitation est autorisée aux deux conditions suivantes:  
(1) l'appareil ne doit pas produire de brouillage,  
et  
(2) l'utilisateur de l'appareil doit accepter tout brouillage radioélectrique subi, même si le brouillage est susceptible d'en compromettre le fonctionnement.

OANATEL353

# 8. Emergency Situations

Hazard Warning Flasher .....	8-2
In Case of an Emergency While Driving .....	8-2
If the Engine Stalls While Driving .....	8-2
If the Engine Stalls at a Crossroad or Crossing .....	8-2
If You Have a Flat Tire While Driving .....	8-3
If the Engine Will Not Start .....	8-3
Jump Starting .....	8-4
If the Engine Overheats .....	8-7
Tire Pressure Monitoring System (TPMS) .....	8-8
Check Tire Pressure .....	8-9
Tire Pressure Monitoring System .....	8-9
Low Tire Pressure Indicator .....	8-10
TPMS (Tire Pressure Monitoring System) malfunction indicator .....	8-11
Changing a Tire with TPMS .....	8-12
If You Have a Flat Tire (With Spare Tire) .....	8-13
Jack and Tools .....	8-14
Removing and Storing the Spare Tire .....	8-14
Changing Tires .....	8-15
Jack Label .....	8-20
Towing .....	8-21
Towing Service .....	8-21
Removable Towing Hook .....	8-23
Emergency Towing .....	8-24

## HAZARD WARNING FLASHER



The hazard warning flasher serves as a warning to other drivers to exercise extreme caution when approaching, overtaking, or passing your vehicle. It should be used whenever emergency repairs are being made or when the vehicle is stopped near the edge of a roadway.

To turn the hazard warning flasher on or off, press the hazard warning flasher button with the ignition switch or Engine Start/Stop button in any position. The hazard warning flasher button is located in the center fascia panel. All turn signal lights will flash simultaneously.

- The hazard warning flasher operates regardless of whether your vehicle is running or not.
- The turn signals do not work when the hazard flasher is on.

## IN CASE OF AN EMERGENCY WHILE DRIVING

### If the Engine Stalls While Driving

- Reduce your speed gradually, keeping a straight line. Move cautiously off the road to a safe place.
- Turn on your hazard warning flasher.
- Try to start the engine again. If your vehicle will not start, contact an authorized HYUNDAI dealer or seek other qualified assistance.

### If the Engine Stalls at a Crossroad or Crossing

If the engine stalls at a crossroads or crossing, if safe to do so, shift the gear to N (Neutral) and then push the vehicle to a safe location.



## If You Have a Flat Tire While Driving

If a tire goes flat while you are driving:

- Take your foot off the accelerator pedal and let the vehicle slow down while driving straight ahead. Do not apply the brakes immediately or attempt to pull off the road as this may cause loss of vehicle control resulting in an accident. When the vehicle has slowed to such a speed that it is safe to do so, brake carefully and pull off the road. Drive off the road as far as possible and park on firm, level ground. If you are on a divided highway, do not park in the median area between the two traffic lanes.
- When the vehicle is stopped, press the hazard warning flasher button, shift the gear to P (Park), apply the parking brake, and place ignition switch to the LOCK/OFF position.
- Have all passengers get out of the vehicle. Be sure they all get out on the side of the vehicle that is away from traffic.
- When changing a flat tire, follow the instructions provided later in this chapter.

## IF THE ENGINE WILL NOT START

- Be sure to shift the gear to N (Neutral) or P (Park). The engine starts only when the gear is in N (Neutral) or P (Park).
- Turn on the interior light. If the light dims or goes out when you operate the starter, the battery is drained. See instructions for “Jump Starting” provided in this chapter.
- Check the fuel level and add fuel if necessary.

If the vehicle still does not start, call an authorized HYUNDAI dealer for assistance.

### **NOTICE**

**Push or pull starting the vehicle may cause the catalytic converter to overload which can lead to damage to the emission control system.**

## JUMP STARTING

Jump starting can be dangerous if done incorrectly. Follow the jump starting procedure in this section to avoid serious injury or damage to your vehicle. If in doubt about how to properly jump start your vehicle, we strongly recommend that you have a service technician or towing service do it for you.



### WARNING

To prevent **SERIOUS INJURY** or **DEATH** to you or bystanders, always follow these precautions when working near or handling the battery:



Always read and follow instructions carefully when handling a battery.



Wear eye protection designed to protect the eyes from acid splashes.



Keep all flames, sparks, or smoking materials away from the battery.



Hydrogen is always present in battery cells, is highly combustible, and may explode if ignited.



Keep batteries out of reach of children.



Batteries contain sulfuric acid which is highly corrosive. Do not allow acid to contact your eyes, skin or clothing.

If acid gets into your eyes, flush your eyes with clean water for at least 15 minutes and get immediate medical attention. If acid gets on your skin, thoroughly wash the area. If you feel pain or a burning sensation, get medical attention immediately.

- When lifting a plastic-cased battery, excessive pressure on the case may cause battery acid to leak. Lift with a battery carrier or with your hands on opposite corners.
- Do not attempt to jump start your vehicle if your battery is frozen.
- NEVER attempt to recharge the battery when the vehicle's battery cables are connected to the battery.
- The electrical ignition system works with high voltage.

NEVER touch these components with the engine running or when the ignition switch or Engine Start/Stop button is in the ON position.

### ***Jump starting procedure***

1. Position the vehicles close enough that the jumper cables will reach, but do not allow the vehicles to touch.
2. Avoid fans or any moving parts in the engine compartment at all times, even when the vehicles are turned off.
3. Turn off all electrical devices such as radios, lights, air conditioning, etc. Put the vehicles in P (Park) and set the parking brake. Turn both vehicles OFF.
4. Open the engine hood.
5. Remove the engine compartment fuse box cover.



### **CAUTION**

**Before jump starting, make sure to correctly identify the positive (+) and negative (-) terminals to avoid reverse polarity connections.**

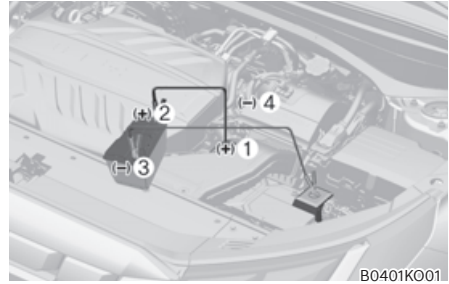

6. Connect the jumper cables in the exact sequence shown in the illustration. First connect one jumper cable to the red, positive (+) jumper terminal of your vehicle ①.
7. Connect the other end of the jumper cable to the red, positive (+) battery/jumper terminal of the assisting vehicle ②.
8. Connect the second jumper cable to the black, negative (-) battery/jumper terminal of the assisting vehicle ③.
9. Connect the other end of the second jumper cable to the black, negative (-) chassis ground of your vehicle ④.

Do not allow the jumper cables to contact anything except the correct battery or jumper terminals or the correct ground. Do not lean over the battery when making connections.



### **WARNING**

**Do not connect the jumper cable to the negative (-) jumper terminal of the discharged battery. A spark could cause the battery to explode and lead to a personal injury or vehicle damage.**

10. Start the engine of the assisting vehicle and let it run at approximately 2,000 RPM for a few minutes. Then start your vehicle.
11. Keep your vehicle operating for at least 30 minutes at idle or driving to assure your battery receives enough charge to be able to start on its own after the vehicle is shut off. A completely discharged battery may require as long as 60 minutes runtime to fully recharge it. If the vehicle has run for less, the vehicle may not restart.

If your vehicle will not start after a few attempts, it probably requires service. In this event please seek qualified assistance. If the cause of your battery discharging is not apparent, have your vehicle checked by an authorized HYUNDAI dealer.

Disconnect the jumper cables in the exact reverse order you connected them:

1. Disconnect the jumper cable from the black, negative (-) chassis ground of your vehicle ④.
2. Disconnect the other end of the jumper cable from the black, negative (-) battery/chassis ground of the assisting vehicle ③.
3. Disconnect the second jumper cable from the red, positive (+) battery/jumper terminal of the assisting vehicle ②.
4. Disconnect the other end of the jumper cable from the red, positive (+) jumper terminal of your vehicle ①.

### Information



**An inappropriately disposed battery can be harmful to the environment and human health. Dispose of the battery according to your local law(s) or regulations.**

### **NOTICE**

**To prevent damage to your vehicle:**

- **Only use a 12-volt power supply (battery or jumper system) to jump start your vehicle.**
- **Do not attempt to jump start your vehicle by push-starting.**

### WARNING

**While jump starting your vehicle, avoid the positive (+) and negative (-) cables to come in contact. A spark could cause personal injury.**

## IF THE ENGINE OVERHEATS

If your temperature gauge indicates overheating, you experience a loss of power, or hear loud pinging or knocking, the engine may be overheating. If this happens, you should:

1. Pull off the road and stop as soon as it is safe to do so.
2. Shift the gear to P (Park) and set the parking brake. If the air conditioning is ON, turn it OFF.
3. If engine coolant is running out under the vehicle or steam is coming out from the hood, stop the engine. Do not open the hood until the coolant has stopped running or the steaming has stopped. If there is no visible loss of engine coolant and no steam, leave the engine running and check to be sure the engine cooling fan is operating. If the fan is not running, turn the engine off.



### WARNING



While the engine is running, keep hands, clothing and tools away from the moving parts such as the cooling fan and drive belt to prevent serious injury.

4. Check for coolant leaking from the radiator, hoses or under the vehicle. (If the air conditioning has been in use, it is normal for cold water to be draining from it when you stop.)
5. If engine coolant is leaking out, stop the engine immediately and call the nearest authorized HYUNDAI dealer for assistance.



### WARNING



Your vehicle is equipped with a pressurized coolant reserve tank. **NEVER** remove the radiator cap or the drain plug while the engine and radiator are **HOT**.

Hot coolant and steam may blow out under pressure, causing serious injury.

Turn the engine off and wait until the engine cools down. Use extreme care when removing the radiator cap. Wrap a towel or thick rag around it, and turn it counterclockwise slowly to release some of the pressure from the system. Step back while the pressure is released.

When you are sure all the pressure has been released, continue turning the cap counter-clockwise to remove it.

6. If you cannot find the cause of the overheating, wait until the engine temperature has returned to normal. Then, if coolant has been lost, carefully add coolant to the reservoir to bring the fluid level in the reservoir up to the halfway mark.
7. Proceed with caution, keeping alert for further signs of overheating. If overheating happens again, call an authorized HYUNDAI dealer for assistance.

 **CAUTION**

- **Serious loss of coolant indicates a leak in the cooling system and have the system checked by an authorized HYUNDAI dealer.**
- **When the engine overheats from low engine coolant, suddenly adding engine coolant may cause cracks in the engine. To prevent damage, add engine coolant slowly in small quantities. It may require several refilling cycles to properly fill the engine cooling system. If necessary, an authorized HYUNDAI dealer should be consulted to perform this task.**

## TIRE PRESSURE MONITORING SYSTEM (TPMS)



- ① Low Tire Pressure Telltale/TPMS Malfunction Indicator
- ② Low Tire Pressure Position Telltale and Tire Pressure Telltale (Shown on the LCD display)

## Check Tire Pressure

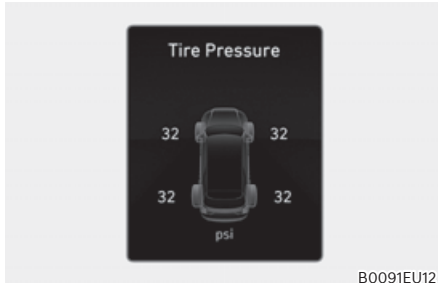

- You can check the tire pressure in the Drive Assist mode on the cluster. Refer to the “View Modes” section in chapter 4.
- Tire pressure is displayed after a few minutes of driving after initial vehicle start up.
- If tire pressure is not displayed when the vehicle is stopped, ‘Drive to display’ message will appear. After driving, check the tire pressure.
- The displayed tire pressure values may differ from those measured with a tire pressure gauge.
- You can change the tire pressure unit from the Settings menu in the infotainment system. Select:
  - Setup → General → Units → Tire Pressure Unit → psi, kpa, bar

### **i** Information

**The infotainment system may change after software updates. For more information, refer to the user’s manual provided in the infotainment system and the quick reference guide.**

## Tire Pressure Monitoring System

### **!** WARNING

**Over-inflation or under-inflation can reduce tire life, adversely affect vehicle handling, and lead to sudden tire failure that may cause loss of vehicle control resulting in an accident.**

Each tire, including the spare (if provided), should be checked monthly when cold and inflated to the inflation pressure recommended by the vehicle manufacturer on the vehicle placard or tire inflation pressure label. (If your vehicle has tires of a different size than the size indicated on the vehicle placard or tire inflation pressure label, you should determine the proper tire inflation pressure for those tires.)

As an added safety feature, your vehicle has been equipped with a tire pressure monitoring system (TPMS) that illuminates a Low Tire Pressure Telltale when one or more of your tires is significantly under-inflated. Accordingly, when the Low Tire Pressure Telltale illuminates, you should stop and check your tires as soon as possible, and inflate them to the proper pressure. Driving on a significantly under-inflated tire causes the tire to overheat and can lead to tire failure.

Under-inflation also reduces fuel efficiency and tire tread life, and may affect the vehicle’s handling and stopping ability.

Please note that the TPMS is not a substitute for proper tire maintenance, and it is the driver’s responsibility to maintain correct tire pressure, even if under-inflation has not reached the level to trigger illumination of the TPMS low tire pressure telltale.

Your vehicle has also been equipped with a TPMS malfunction indicator to indicate when the system is not operating properly. The TPMS malfunction indicator is combined with the Low Tire Pressure Telltale. When the system detects a malfunction, the telltale will flash for approximately one minute and then remain continuously illuminated. This sequence will continue upon subsequent vehicle start-ups as long as the malfunction exists.

When the malfunction indicator is illuminated, the system may not be able to detect or signal low tire pressure as intended. TPMS malfunctions may occur for a variety of reasons, including the installation of replacement or alternate tires or wheels on the vehicle that prevent the TPMS from functioning properly.

Always check the TPMS malfunction telltale after replacing one or more tires or wheels on your vehicle to ensure that the replacement or alternate tires and wheels allow the TPMS to continue to function properly.

### **NOTICE**

**If any of the below happens, have the system checked by an authorized HYUNDAI dealer.**

- 1. The Low Tire Pressure Telltale/ TPMS Malfunction Indicator does not illuminate for 3 seconds when the ignition switch or Engine Start/Stop button is placed to the ON position or when the engine is running.**
- 2. The TPMS Malfunction Indicator remains illuminated after blinking for approximately 1 minute.**
- 3. The Low Tire Pressure Position Telltale remains illuminated.**

## Low Tire Pressure Indicator



- Ⓐ: Low Tire Pressure Warning Light,  
Ⓑ: Low Tire Pressure Position and Tire Pressure Telltale

When the tire pressure monitoring system warning indicators are illuminated and a warning message displayed on the cluster LCD display, one or more of your tires is significantly under-inflated. The Low Tire Pressure Position Telltale will indicate which tire is significantly underinflated by illuminating the corresponding position light.

If either telltale illuminates, immediately reduce your speed, avoid hard cornering and anticipate increased stopping distances. You should stop and check your tires as soon as possible. Inflate the tires to the proper pressure as indicated on the vehicle's placard or tire inflation pressure label located on the driver's side center pillar outer panel.



If you cannot reach a service station or if the tire cannot hold the newly added air, replace the low pressure tire with the spare tire.

The Low Tire Pressure LCD position indicator will remain on and the TPMS Malfunction Indicator may blink for one minute and then remain illuminated until you have the low pressure tire repaired and replaced on the vehicle.



### CAUTION

In winter or cold weather, the Low Tire Pressure Telltale may be illuminated if the tire pressure was adjusted to the recommended tire inflation pressure in warm weather. It does not mean your TPMS is malfunctioning because the decreased temperature leads to a proportional lowering of tire pressure.

When you drive your vehicle from a warm area to a cold area or from a cold area to a warm area, or the outside temperature is greatly higher or lower, you should check the tire inflation pressure and adjust the tires to the recommended tire inflation pressure.



### WARNING

**Low pressure damage**

Significantly low tire pressure makes the vehicle unstable and can contribute to loss of vehicle control and increased braking distances.

Continued driving on low pressure tires can cause the tires to overheat and fail.



### TPMS (Tire Pressure Monitoring System) malfunction indicator

The TPMS Malfunction Indicator will illuminate after it blinks for approximately one minute when there is a problem with the Tire Pressure Monitoring System.

Have the system checked by an authorized HYUNDAI dealer as soon as possible.

### NOTICE

If there is a malfunction with the TPMS, the Low Tire Pressure Position Telltale will not be displayed even though the vehicle has an under-inflated tire.

### NOTICE

The TPMS Malfunction Indicator may illuminate after blinking for one minute if the vehicle is near electric power supply cables or radio transmitters such as police stations, government and public offices, broadcasting stations, military installations, airports, transmitting towers, etc.

Additionally, the TPMS Malfunction Indicator may illuminate if snow chains are used or electronic devices such as computers, chargers, remote starters, navigation, etc. This may interfere with normal operation of the TPMS.

### Changing a Tire with TPMS

If you have a flat tire, the Low Tire Pressure and Position telltales will come on. Have the flat tire repaired by an authorized HYUNDAI dealer as soon as possible or replace the flat tire with the spare tire.

#### **NOTICE**

**It is recommended that you do not use a puncture-repairing agent not approved by HYUNDAI dealer or the equivalent specified for your vehicle to repair and/or inflate a low pressure tire. Tire sealant not approved by HYUNDAI dealer or the equivalent specified for your vehicle may damage the tire pressure sensor.**

The spare tire (if equipped) does not come with a tire pressure monitoring sensor. When the low pressure tire or the flat tire is replaced with the spare tire, the Low Tire Pressure Telltale will remain on. Also, the TPMS Malfunction Indicator will illuminate after blinking for one minute if the vehicle is driven at speed above 15.5 mph (25 km/h) for approximately 10 minutes.

Once the original wheel equipped with a tire pressure monitoring sensor is reinflated to the recommended pressure and reinstalled on the vehicle, the Low Tire Pressure Telltale and TPMS Malfunction Indicator will go off within a few minutes of driving.

If the indicators do not extinguish after a few minutes, please visit an authorized HYUNDAI dealer.

Each wheel is equipped with a tire pressure sensor mounted inside the tire behind the valve stem (except for the spare tire). You must use TPMS specific wheels. It is recommended that you always have your tires serviced by an authorized HYUNDAI dealer.

You may not be able to identify a tire with low pressure by simply looking at it. Always use a good quality tire pressure gauge to measure. Please note that a tire that is hot (from being driven) will have a higher pressure measurement than a tire that is cold.

A cold tire means the vehicle has been sitting for 3 hours and driven for less than 1 mile (1.6 km) in that 3 hour period.

Allow the tire to cool before measuring the inflation pressure. Always be sure the tire is cold before inflating to the recommended pressure.



#### **WARNING**

- **The TPMS cannot alert you to severe and sudden tire damage caused by external factors such as nails or road debris.**
- **If you feel any vehicle instability, immediately take your foot off the accelerator, apply the brakes gradually with light force, and slowly move to a safe position off the road.**

**WARNING**

Tampering with, modifying, or disabling the Tire Pressure Monitoring System (TPMS) components may interfere with the system's ability to warn the driver of low tire pressure conditions and/or TPMS malfunctions. Tampering with, modifying, or disabling the Tire Pressure Monitoring System (TPMS) components may void the warranty for that portion of the vehicle.

**WARNING**

This device complies with Part 15 of the FCC rules.

1. This device may not cause harmful interference.
2. This device must accept any interference received, including interference that may cause undesired operation.
3. Changes or modifications not expressly approved by the party responsible for compliance could void the user's authority to operate the equipment.

**IF YOU HAVE A FLAT TIRE  
(WITH SPARE TIRE)****WARNING**

Changing a tire can be dangerous. Follow the instructions in this section when changing a tire to reduce the risk of serious injury or death.

**CAUTION**

Be careful as you use the jack handle to stay clear of the flat end. The flat end has sharp edges that could cause cuts.

## Jack and Tools

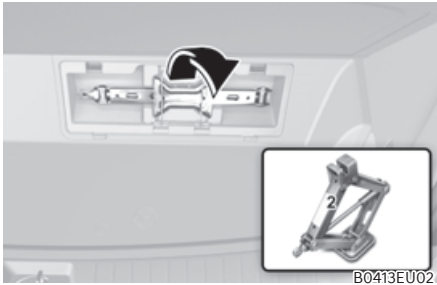
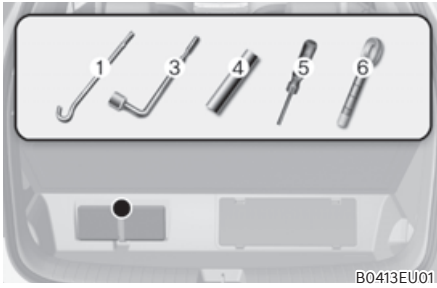

- ① Jack handle
- ② Jack
- ③ Wheel lug nut wrench
- ④ Socket
- ⑤ Screwdriver
- ⑥ Towing hook

The jack, jack handle, wheel lug nut wrench and socket are stored in the luggage compartment under the liftgate box cover.

The jack is provided for emergency tire changing only.

## Removing and Storing the Spare Tire



Your spare tire is stored underneath your vehicle, directly below the cargo area.

To remove the spare tire:

1. Open the liftgate.
2. Find the plastic hex bolt cover and remove the cover with a coin or flat-blade screwdriver.

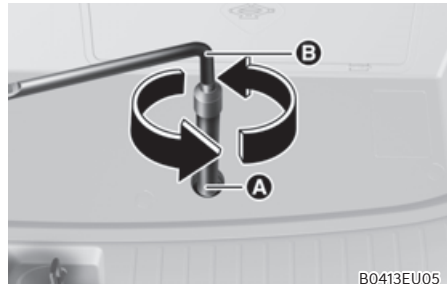

3. Connect the socket (A) and wheel lug nut wrench (B).
4. Loosen the bolt enough to lower the spare tire.  
Turn the wrench counterclockwise until the spare tire reaches the ground.
5. After the spare tire reaches the ground, continue to turn the wrench counterclockwise, and draw the spare tire outside. Never rotate the wrench excessively, otherwise the spare tire carrier may be damaged.

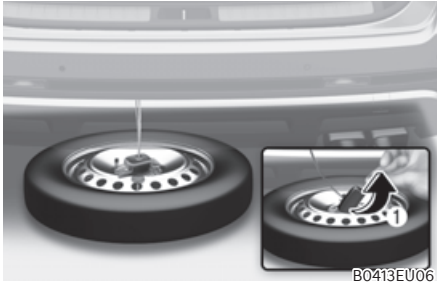

6. Draw out the retainer guide ① through the center hole of the spare tire.

To store the spare tire:

1. Lay the tire on the ground with the valve stem facing up.
2. Place the wheel under the vehicle and install the retainer guide and chain through the wheel center.
3. Turn the wrench clockwise until it clicks.

### CAUTION

Ensure the spare tire retainer guide is properly aligned with the center of the spare tire to prevent the spare tire from “rattling”.

Otherwise, it may cause the spare tire to fall off the carrier and lead to an accident.

## Changing Tires

### WARNING

A vehicle can slip or roll off of a jack causing serious injury or death to you or those nearby. Take the following safety precautions:

- Never place any portion of your body under a vehicle that is supported by a jack.
- NEVER attempt to change a tire in the lane of traffic. ALWAYS move the vehicle completely off the road on level, firm ground away from traffic before trying to change a tire. If you cannot find a level, firm place off the road, call a towing service for assistance.
- Be sure to use the jack provided with the vehicle.
- ALWAYS place the jack on the designated jacking positions on the vehicle and NEVER on the bumpers or any other part of the vehicle for jacking support.
- Do not start or run the engine while the vehicle is on the jack.
- Do not allow anyone to remain in the vehicle while it is on the jack.
- Keep children away from the road and the vehicle.

Follow these steps to change your vehicle's tire:

1. Park on a level, firm surface.
2. Move the shift button into P (Park), apply the parking brake, and place the ignition switch or press Engine Start/ Stop button in the LOCK/OFF position.
3. Press the hazard warning flasher button.
4. Remove the wheel lug nut wrench, jack, jack handle and spare tire from the vehicle.
5. Block both the front and rear of the tire diagonally opposite of the tire you are changing.



6. Loosen the wheel lug nuts counterclockwise one turn each in the order shown above, but do not remove any lug nuts until the tire has been raised off of the ground.

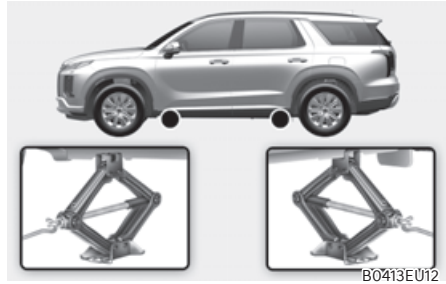

Ⓐ: Rear, Ⓑ: Front

7. Place the jack at the designated jacking position under the frame closest to the tire you are changing. The jacking positions are plates welded to the frame with two notches. Never jack at any other position or part of the vehicle. Doing so may damage the side seal molding or other parts of the vehicle.

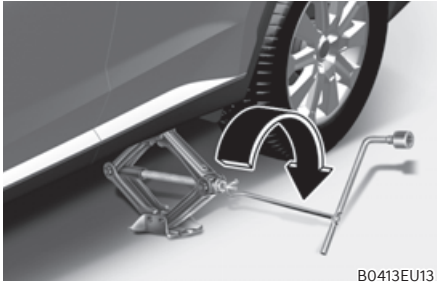

B0413EU13

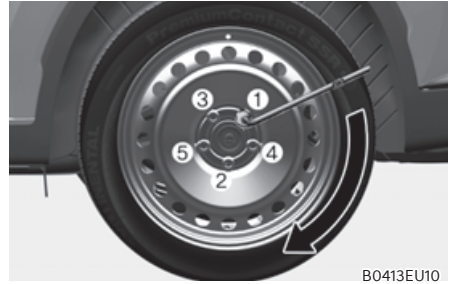

B0413EU10

8. Insert the jack handle into the jack and turn it clockwise, raising the vehicle until the tire clears the ground. Make sure the vehicle is stable on the jack.
9. Loosen the lug nuts with the wheel lug nut wrench and remove them with your fingers. Remove the wheel from the studs and lay it flat on the ground out of the way. Remove any dirt or debris from the studs, mounting surfaces, and wheel.
10. Install the spare tire onto the studs of the hub.
11. Tighten the lug nuts with your fingers onto the studs with the smaller end of the lug nuts closest to the wheel.
12. Lower the vehicle to the ground by turning the jack handle counterclockwise.

13. Use the wheel lug nut wrench to tighten the lug nuts in the order shown. Double-check each lug nut until they are tight. After changing tires, have an authorized HYUNDAI dealer tighten the lug nuts to their proper torque as soon as possible. **The wheel lug nut should be tightened to 11–13 kgf·m (79–94 lbf·ft).**

If you have a tire gauge, check the tire pressure (see “Tires and Wheels” section in chapter 2 for tire pressure instructions.). If the pressure is lower or higher than recommended, drive slowly to the nearest service station and adjust it to the recommended pressure. Always reinstall the valve cap after checking or adjusting tire pressure. If the cap is not replaced, air may leak from the tire. If you lose a valve cap, buy another and install it as soon as possible. After changing tires, secure the flat tire and return the jack and tools to their proper storage locations.

### **NOTICE**

- Check the tire pressure as soon as possible after installing a spare tire. Adjust it to the recommended pressure.
- Check and tighten the wheel lug nuts after driving over 50 km (30 mile) if tires are replaced. Recheck the tire wheel lug nuts after driving over 1,000 km (600 mile).



### **CAUTION**

Your vehicle has metric threads on the studs and wheel bolts. Make certain during tire changing that the same bolts that were removed are reinstalled. If you have to replace your wheel bolts make sure they have metric threads to avoid damaging the studs and ensure the wheel is properly secured to the hub. Consult an authorized HYUNDAI dealer for assistance.

If any of the equipment such as the jack, wheel nuts, studs, or other equipment is damaged or in poor condition, do not attempt to change the tire and call for assistance.

### ***Use of compact spare tires***

Compact spare tires are designed for emergency use only. Drive carefully on the compact spare tire and always follow the safety precautions.



### **WARNING**

To prevent compact spare tire failure and loss of control possibly resulting in an accident:

- Use the compact spare tire only in an emergency.
- NEVER operate your vehicle over 50 mph (80 km/h).
- Do not exceed the vehicle's maximum load rating or the load carrying capacity shown on the sidewall of the compact spare tire.
- Do not use the compact spare tire continuously. Repair or replace the original tire as soon as possible to avoid failure of the compact spare tire.



When driving with the compact spare tire mounted to your vehicle:

- Check the tire pressure after installing the compact spare tire. The compact spare tire should be inflated to 60 psi (420 kPa).
- Do not take this vehicle through an automatic car wash while the compact spare tire is installed.
- Do not use the compact spare tire on any other vehicle because this tire has been designed especially for your vehicle.
- The compact spare tire's tread life is shorter than a regular tire. Inspect your compact spare tire regularly and replace worn compact spare tires with the same size and design, mounted on the same wheel.
- Do not use more than one compact spare tire at a time.
- Do not tow a trailer while the compact spare tire is installed.

### **NOTICE**

**When the original tire and wheel are repaired and reinstalled on the vehicle, the lug nut torque must be set correctly. The correct lug nut tightening torque is 79~94 lbf-ft (11~13 kgf-m).**

### **NOTICE**

**To prevent damaging the compact spare tire and your vehicle:**

- **Drive slowly enough for the road conditions to avoid all hazards, such as a potholes or debris.**
- **Avoid driving over obstacles. The compact spare tire diameter is smaller than the diameter of a conventional tire and reduces the ground clearance approximately 1 inch (25 mm).**
- **Do not use tire chains on the compact spare tire. Because of the smaller size, a tire chain will not fit properly.**
- **Do not use the compact spare tire on any other wheels, nor should standard tires, snow tires, wheel covers or trim rings be used with the compact spare wheel.**
- **Do not suddenly accelerate or decelerate (0 - 25 mph (0 - 40 km/h)) in any driving mode. It may cause leakage of transfer oil.**

## Jack Label

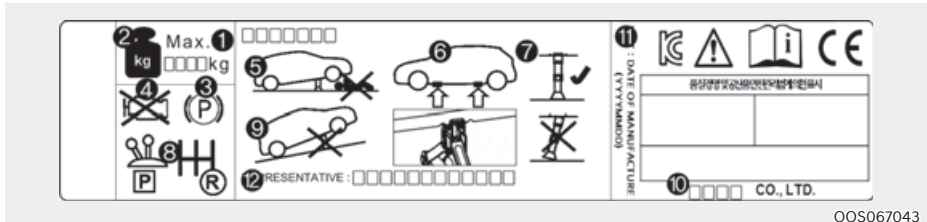

OOS067043

The actual Jack label in the vehicle may differ from the illustration.

For more detailed specifications, refer to the label attached to the jack.

- ① Model Name
- ② Maximum allowable load
- ③ When using the jack, set your parking brake.
- ④ When using the jack, stop the engine.
- ⑤ Do not get under a vehicle that is supported by a jack.
- ⑥ The designated locations under the frame
- ⑦ When supporting the vehicle, the base plate of jack must be vertical under the lifting point.
- ⑧ Shift into Reverse gear on vehicles with manual transmission or shift the gear to the P position on vehicles with automatic transmission.
- ⑨ The jack should be used on firm level ground.
- ⑩ Jack manufacture
- ⑪ Production date
- ⑫ Representative company and address

## TOWING

### Towing Service

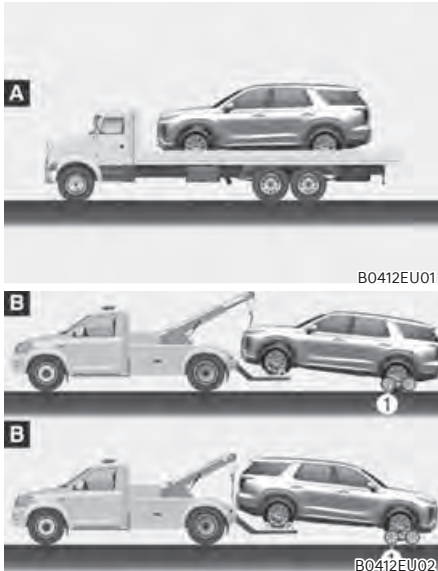

①: Dollies

If emergency towing is necessary, we recommend having it done by an authorized HYUNDAI dealer or a commercial tow-truck service. Proper lifting and towing procedures are necessary to prevent damage to the vehicle. The use of wheel dollies or flatbed is recommended.

On 2WD vehicles, it is acceptable to tow the vehicle with the rear wheels on the ground (without dollies) and the front wheels off the ground. If any of the loaded wheels or suspension components are damaged or the vehicle is being towed with the front wheels on the ground, use a towing dolly under the front wheels.

When being towed by a commercial tow truck and wheel dollies are not used, the front of the vehicle should always be lifted, not the rear.

If your vehicle is an 4WD vehicle, it must be towed with a wheel lift and dollies or flatbed equipment with all the wheels off the ground.

### NOTICE

- **Do not lift the vehicle by the tow fitting or body and chassis parts. Otherwise the vehicle may be damaged.**
- **A 4WD vehicle should never be towed with the wheels on the ground. This can cause serious damage to the transmission or the 4WD system.**



**CAUTION**

- Do not tow the vehicle with the front wheels on the ground as this may cause damage to the vehicle.

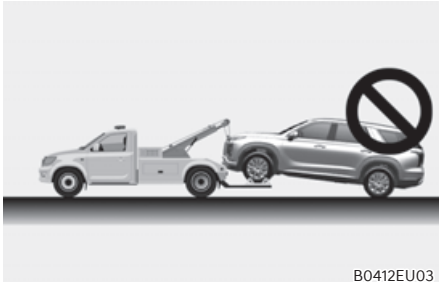

B0412EU03

- Do not tow with sling-type equipment. Use wheel lift or flatbed equipment.

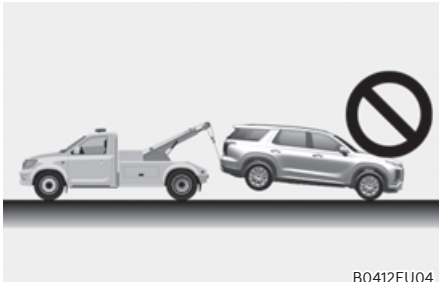

B0412EU04



**WARNING**

If your vehicle is equipped with a rollover sensor, place the ignition switch or press Engine Start/Stop button in the LOCK/OFF or ACC position when the vehicle is being towed. The side impact and curtain air bag may deploy if the sensor detects the situation as a rollover.

When towing your vehicle in an emergency without wheel dollies:

1. Release EPB before turning off the engine.
2. Place the ignition switch or press the ignition switch to ON/OFF position.
3. Change the gear to N (Neutral) while pressing the brake pedal. For more details, refer to “Automatic Transmission” section in chapter 6.
4. Place the ignition switch to the ACC position.



**CAUTION**

Failure to shift the gear to N (Neutral) may cause internal damage to the transmission.

## Removable Towing Hook

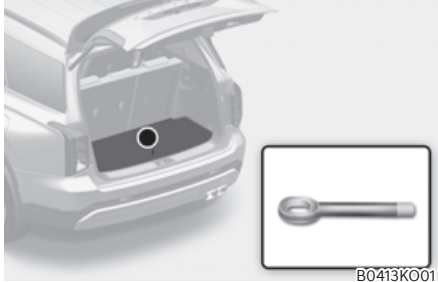

1. Open the liftgate, and remove the towing hook from the tool case.
2. Remove the hole cover.

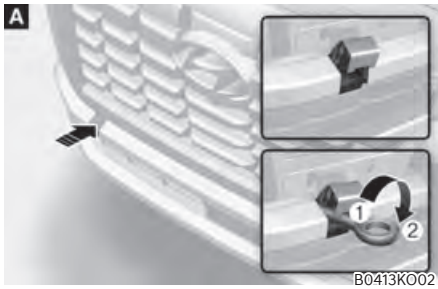

Ⓐ: Front

- Push the lower part of the bumper hole cover.

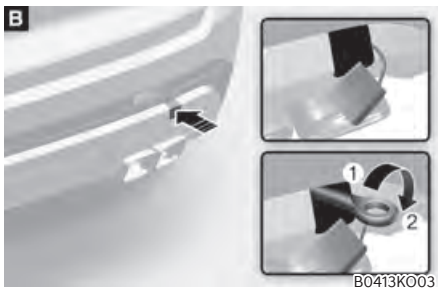

Ⓑ: Rear

- Push the left part of the bumper hole cover.

3. Install the towing hook by turning it clockwise into the hole until it is fully secured.
4. Remove the towing hook and install the cover after use.

### NOTICE

Failure to properly tighten the towing hook may result in vehicle damage and deformation of related parts.



### CAUTION

Make sure the towing hook is tighten properly. If not, during towing the towing hook may be thrown off the vehicle resulting in serious injury or accident.

### Emergency Towing

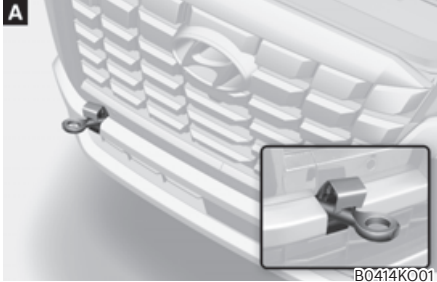

Ⓐ: Front

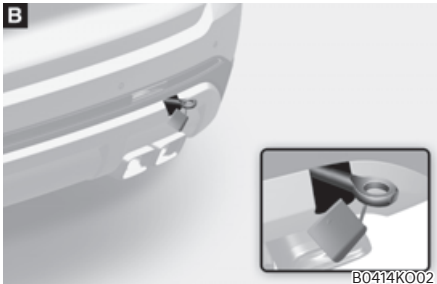

Ⓑ: Rear

If towing is necessary, have it done by an authorized HYUNDAI dealer or a commercial tow truck service.

If towing service is not available in an emergency, your vehicle may be temporarily towed using a cable or chain secured to the emergency towing hook at the front (or rear) of the vehicle.

Use extreme caution when towing the vehicle with a cable or chain. A driver must be in the vehicle to steer it and operate the brakes.

Towing in this manner may be done only on hard-surfaced roads for a short distance and at low speeds. Also, the wheels, axles, power train, steering and brakes must all be in good working condition.

### CAUTION

**The driver must be in the vehicle for steering and braking operations when the vehicle is being towed. Passengers other than the driver must not be in the vehicle.**

Always follow these emergency towing precautions:

- Place the ignition switch or press the Engine Start/Stop button to the ACC position so the steering wheel is not locked.
- Shift the gear to N (Neutral).
- Release the parking brake.
- Depress the brake pedal with more force than normal as you will have reduced braking performance.
- More steering effort will be required because the power steering system will be disabled.
- Use a vehicle heavier than your own to tow your vehicle.
- The drivers of both vehicles should communicate with each other frequently.
- Before emergency towing, check that the hook is not broken or damaged.
- Fasten the towing cable or chain securely to the hook.
- Do not jerk the hook. Apply steady and even force.

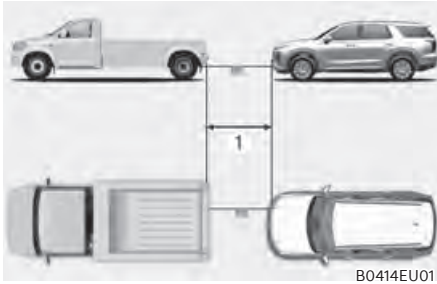

B0414EU01

①: Distance

- Use a towing cable or chain less than 16 ft. (5 m) long. Attach a white or red cloth (about 12 in. (30 cm) wide) in the middle of the cable or chain for easy visibility.
- Drive carefully so the towing cable or chain remains tight during towing.
- Before towing, check the automatic transmission for fluid leaks under your vehicle. If the automatic transmission fluid is leaking, flatbed equipment or a towing dolly must be used.

### NOTICE

**Accelerate or decelerate the vehicle in a slow and gradual manner while maintaining tension on the tow rope or chain to start or drive the vehicle, otherwise tow hooks and the vehicle may be damaged.**

### NOTICE

**To avoid damage to your vehicle and vehicle components when towing:**

- **Always pull straight ahead when using the towing hooks. Do not pull from the side or at a vertical angle.**
- **Do not use the towing hooks to pull a vehicle out of mud, sand or other conditions from which the vehicle cannot be driven out under its own power.**
- **Limit the vehicle speed to 10 mph (15 km/h) and drive less than 1 mile (1.5 km) when towing to avoid serious damage to the automatic transmission.**

# 9. Maintenance

Engine Compartment .....	9-3
Maintenance Services .....	9-4
Owner's Responsibility .....	9-4
Owner Maintenance Precautions.....	9-4
Owner Maintenance .....	9-5
Owner Maintenance Schedule.....	9-6
Scheduled Maintenance Services .....	9-7
Normal Maintenance Schedule.....	9-8
Maintenance Under Severe Usage Conditions .....	9-11
Explanation of Scheduled Maintenance Items.....	9-13
Engine Oil .....	9-15
Checking the Engine Oil Level.....	9-15
Checking the Engine Oil and Filter .....	9-16
Engine Coolant.....	9-18
Checking the Coolant Level.....	9-18
Changing Coolant .....	9-20
Brake Fluid.....	9-21
Checking the Brake Fluid Level.....	9-21
Washer Fluid.....	9-22
Checking the Washer Fluid Level.....	9-22
Air Cleaner .....	9-23
Filter Replacement.....	9-23
Cabin Air Filter.....	9-24
Filter Inspection.....	9-24
Filter Replacement.....	9-24
Wiper Blades .....	9-25
Blade Inspection .....	9-25
Blade Replacement.....	9-25
Battery .....	9-27
For Best Battery Service .....	9-28
Battery Capacity Label.....	9-29
Battery Recharging .....	9-29
Reset Items.....	9-30



Tires and Wheels.....	9-31
Tire Care.....	9-31
Recommended Cold Tire Inflation Pressures.....	9-31
Check Tire Inflation Pressure.....	9-32
Tire Rotation .....	9-33
Wheel Alignment and Tire Balance.....	9-34
Tire Replacement .....	9-34
Wheel Replacement.....	9-35
Tire Traction .....	9-35
Tire Maintenance.....	9-35
Tire Sidewall Labeling .....	9-36
Tire Terminology and Definitions .....	9-39
All Season Tires.....	9-42
Summer Tires .....	9-42
Snow Tires.....	9-43
Radial-Ply Tires.....	9-43
Low Aspect Ratio Tires.....	9-44
Fuses.....	9-45
Instrument Panel Fuse Replacement.....	9-46
Engine Compartment Panel Fuse Replacement.....	9-47
Fuse/Relay Panel Description.....	9-48
Light Bulbs.....	9-56
Headlight, Position Lamp, Turn Signal Lamp, Daytime Running Light (DRL) Replacement .....	9-57
Side Repeater Lamp Replacement .....	9-58
Rear Combination Lamp Replacement .....	9-58
High Mounted Stop Lamp Replacement.....	9-60
License Plate Lamp Replacement.....	9-60
Interior Light Replacement.....	9-61
Appearance Care .....	9-63
Exterior Care .....	9-63
Interior Care.....	9-68
Emission Control System.....	9-71
California Perchlorate Notice.....	9-74

## ENGINE COMPARTMENT

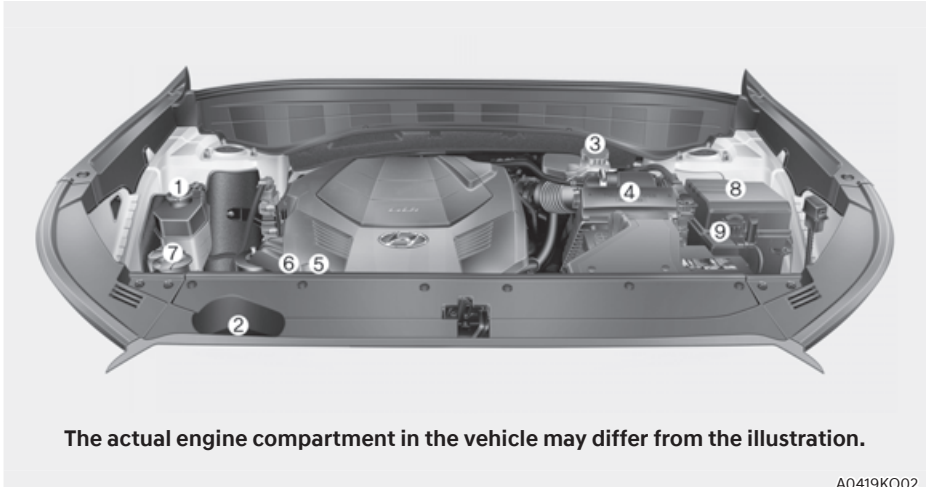

**The actual engine compartment in the vehicle may differ from the illustration.**

A0419KO02

1. Engine coolant reservoir
2. Radiator cap
3. Brake fluid reservoir
4. Air cleaner
5. Engine oil filler cap
6. Engine oil dipstick
7. Windshield washer fluid reservoir
8. Fuse/relay box
9. Battery

## MAINTENANCE SERVICES

You should exercise the utmost care to prevent damage to your vehicle and injury to yourself whenever performing any maintenance or inspection procedures.

Have your vehicle maintained and repaired by an authorized HYUNDAI dealer. An authorized HYUNDAI dealer meets HYUNDAI's high service quality standards and receives technical support from HYUNDAI in order to provide you with a high level of service satisfaction.

### Owner's Responsibility

Maintenance service and record retention are the owner's responsibility.

You should retain documents that show proper maintenance has been performed on your vehicle in accordance with the scheduled maintenance service charts shown on the following pages. You need this information to establish your compliance with the servicing and maintenance requirements of your vehicle warranties.

Detailed warranty information is provided in your Owner's Handbook & Warranty Information booklet.

Repairs and adjustments required as a result of improper maintenance or a lack of required maintenance are not covered.

### Owner Maintenance Precautions

Inadequate, incomplete or insufficient servicing may result in operational problems with your vehicle that could lead to vehicle damage, an accident, or personal injury. This chapter provides instructions only for the maintenance items that are easy to perform. Several procedures can be done only by an authorized HYUNDAI dealer with special tools.

Your vehicle should not be modified in any way. Such modifications may adversely affect the performance, safety or durability of your vehicle and may, in addition, violate conditions of the limited warranties covering the vehicle.

Certain modifications may also be in violation of regulations established by the U.S. Department of Transportation and other federal or state agencies.

#### **NOTICE**

**Improper owner maintenance during the warranty period may affect warranty coverage. For details, read the separate Owner's Handbook & Warranty Information booklet provided with the vehicle. If you're unsure about any service or maintenance procedure, have it done by an authorized HYUNDAI dealer.**

## OWNER MAINTENANCE



### WARNING

Performing maintenance work on a vehicle can be dangerous. If you lack sufficient knowledge and experience or the proper tools and equipment to do the work, have it done by an authorized HYUNDAI dealer.

**ALWAYS** follow these precautions for performing maintenance work:

- **Park your vehicle on level ground. Shift the vehicle to P (Park), apply the parking brake, and place the ignition switch to the OFF position.**
- **Block the tires (front and back) to prevent the vehicle from moving. Remove loose clothing or jewelry that can become entangled in moving parts.**
- **If you must run the engine during maintenance, do so out doors or in an area with plenty of ventilation.**
- **Keep flames, sparks, or smoking materials away from the battery and fuel-related parts.**



### WARNING

#### Touching metal parts



**Do not touch metal parts (including strut bars) while the engine is operating or hot. Doing so could result in serious personal injury. Turn the engine off and wait until the metal parts cool down to perform maintenance work on the vehicle.**

The following lists are vehicle checks and inspections that should be performed by the owner or an authorized HYUNDAI dealer at the frequencies indicated to help ensure safe, dependable operation of your vehicle.

Any adverse conditions should be brought to the attention of your dealer as soon as possible.

These Owner Maintenance vehicle checks are generally not covered by warranties and you may be charged for labor, parts and lubricants used.

## Owner Maintenance Schedule

### **When you stop for fuel:**

- Check the coolant level in the engine coolant reservoir.
- Check the windshield washer fluid level.
- Check for low or under-inflated tires.



### **WARNING**

**Be careful when checking your coolant level when the engine is hot. This may result in coolant being blown out of the opening and cause serious burns and other injuries.**

### **While operating your vehicle:**

- Note any changes in the sound of the exhaust or any smell of exhaust fumes in the vehicle.
- Check for vibrations in the steering wheel. Notice if there is any increased steering effort or looseness in the steering wheel, or change in its straight-ahead position.
- Notice if your vehicle constantly turns slightly or “pulls” to one side when traveling on smooth, level road.
- When stopping, listen and check for unusual sounds, pulling to one side, increased brake pedal travel or “hard-to-push” brake pedal.
- If any slipping or changes in the operation of your transmission occurs, check the transmission fluid level.
- Check the automatic transmission P (Park) function.
- Check the parking brake.
- Check for fluid leaks under your vehicle (water dripping from the air conditioning system during or after use is normal).

### **At least monthly:**

- Check coolant level in the engine coolant reservoir.
- Check the operation of all exterior lights, including the stoplights, turn signals and hazard warning flashers.
- Check the inflation pressures of all tires including the spare for tires that are worn, show uneven wear, or are damaged.
- Check for loose wheel lug nuts.

### **At least twice a year: (for example, every Spring and Autumn)**

- Check radiator, heater and air conditioning hoses for leaks or damage.
- Check windshield washer spray and wiper operation. Clean wiper blades with a clean cloth dampened with washer fluid.
- Check headlight alignment.
- Check muffler, exhaust pipes, shields and clamps.
- Check the seat belts for wear and function.

### **At least once a year:**

- Clean body and door drain holes.
- Lubricate door hinges and hood hinges.
- Lubricate door and hood locks and latches.
- Lubricate door rubber weather strips.
- Check the air conditioning system.
- Inspect and lubricate automatic transmission linkage and controls.
- Clean the battery and terminals.
- Check the brake fluid level.

## SCHEDULED MAINTENANCE SERVICES

Follow Normal Maintenance Schedule if the vehicle is usually operated where none of the following conditions apply. If any of the following conditions apply, you must follow the Maintenance Under Severe Usage Conditions.

- Repeated driving short distance of less than 5 miles (8 km) in normal temperature or less than 10 miles (16 km) in freezing temperature
- Extensive engine idling or low speed driving for long distances
- Driving on rough, dusty, muddy, unpaved, graveled or salt-spread roads
- Driving in areas using salt or other corrosive materials or in very cold weather
- Driving in heavy dust conditions
- Driving in heavy traffic area
- Driving on uphill, downhill, or mountain road repeatedly
- Using for towing or camping, and driving with loads on the roof
- Driving as a patrol car, taxi, other commercial use of vehicle towing
- Frequently driving under high speed or rapid acceleration/deceleration
- Frequently driving in stop-and-go condition
- Engine oil usage which is not recommended (Mineral type, Semi-synthetic, Lower grade spec, etc.)

If your vehicle is operated under the above conditions, you should inspect, replace or refill more frequently than the following Normal Maintenance Schedule. After the periods or distance shown in the chart, continue to follow the prescribed maintenance intervals.

### NOTICE

**After driving more than 10 years or 100,000 miles, use severe maintenance schedule.**



### Information

- **As it is normal for engine oil to be consumed during driving, the engine oil level should be checked on regular basis.**
- **The engine oil change interval for normal operating conditions is based on the use of the recommended engine specification. If the recommended engine oil specification is not used, then replace the engine oil according to the maintenance schedule under severe operating conditions.**

## Normal Maintenance Schedule

MAINTENANCE INTERVALS		Number of months or driving distance, whichever comes first													
		12	24	36	48	60	72	84	96	108	120	132	144	156	
MAINTENANCE ITEM	Months	8	16	24	32	40	48	56	64	72	80	88	96	104	
	Miles*1,000	13	26	39	52	65	78	91	104	117	130	143	156	169	
	Km *1,000	At first, inspect at 48,000 miles (78,000 km) or 72 months, after that, inspect every 8,000 miles (13,000 km) or 12 months													
Drive belts *1		R	R	R	R	R	R	R	R	R	R	R	R	R	R
Engine oil and engine oil filter		Add every 8,000 miles (13,000 km) or 12 months													
Fuel additives *2		I	I	R	I	I	R	I	I	R	I	I	R	I	I
Air cleaner filter		Replace every 96,000 miles (156,000 km)													
Spark plugs		Inspect every 64,000 miles (104,000 km) or 72 months													
Valve clearance *3		Rotate tires every 8,000 miles (13,000 km) or 12 months													
Rotate Tires (includes tread wear inspection and tire pressure check)															

I : Inspect and if necessary, adjust, correct, clean or replace.

R : Replace or change.

\*1: The drive belt should be replaced when cracks occur or tension is reduced.

\*2: If TOP TIER Detergent Gasoline is not available, one bottle of additive is recommended. Additives are available from your authorized HYUNDAI dealer along with information on how to use them. Do not mix other additives.

\*3: inspect for excessive valve noise and/or engine vibration and adjust if necessary. Have an authorized HYUNDAI dealer perform the operation.

\* As it is normal for engine oil to be consumed during driving, the amount of engine oil should be checked regularly.

\* The replacement cycle of engine oil is set by the period which the performance of our recommended engine oil is maintained. So, if recommended engine oil is not used, a replacement is required as indicated severe usage condition.

## Normal Maintenance Schedule (Cont.)

MAINTENANCE INTERVALS	Number of months or driving distance, whichever comes first														
	Months	12	24	36	48	60	72	84	96	108	120	132	144	156	
	Miles×1,000	8	16	24	32	40	48	56	64	72	80	88	96	104	
MAINTENANCE ITEM	Km×1,000	13	26	39	52	65	78	91	104	117	130	143	156	169	
Cabin air filter (if equipped)		R	I	I	R	I	I	I	R	I	R	I	I	I	
Vacuum hose		I	I	I	I	I	I	I	I	I	I	I	I	I	
Engine coolant		At first, replace at 120,000 miles (200,000 km) or 120 months. After that, replace every 24,000 miles (39,000 km) or 24 months													
Battery condition		I	I	I	I	I	I	I	I	I	I	I	I	I	
Brake lines, hoses and connections		I	I	I	I	I	I	I	I	I	I	I	I	I	
Disc brakes and pads		I	I	I	I	I	I	I	I	I	I	I	I	I	
Steering gear rack, linkage and boots		I	I	I	I	I	I	I	I	I	I	I	I	I	
Driveshaft and boots		I	I	I	I	I	I	I	I	I	I	I	I	I	
Suspension mounting bolts		I	I	I	I	I	I	I	I	I	I	I	I	I	
Air conditioner refrigerant		I	I	I	I	I	I	I	I	I	I	I	I	I	
Air conditioner compressor		I	I	I	I	I	I	I	I	I	I	I	I	I	
Propeller shaft (AWD)		I	I	I	I	I	I	I	I	I	I	I	I	I	
Exhaust pipe and muffler		I	I	I	I	I	I	I	I	I	I	I	I	I	

I : Inspect and if necessary, adjust, correct, clean or replace.

R : Replace or change.



Normal Maintenance Schedule (Cont.)

MAINTENANCE INTERVALS	Number of months or driving distance, whichever comes first														
	Months	12	24	36	48	60	72	84	96	108	120	132	144	156	
MAINTENANCE ITEM	Miles×1,000	8	16	24	32	40	48	56	64	72	80	88	96	104	
	Km×1,000	13	26	39	52	65	78	91	104	117	130	143	156	169	
Automatic transmission fluid		No check, No service required													
Rear differential oil (AWD) *4					I				I				I		
Transfer case oil (AWD) *4					I				I				I		
Vapor hose, fuel filler cap and fuel tank					I		I		I		I		I		
Fuel tank air filter *5					I		I		I		I		I		
Fuel lines, hoses and connections					I		I		I		I		I		
Parking brake					I		I		I		I		I		
Brake fluid		At first, inspect every 8,000 miles (13,000 km) or 12 months, after that, replace every 48,000 miles (78,000 km) or 48 months													

I : Inspect and if necessary, adjust, correct, clean or replace.

R : Replace or change.

\*4 : Rear differential oil and transfer case oil should be changed anytime they have been submerged in water.

\*5 : Fuel filter & Fuel tank air filter are considered to be maintenance free but periodic inspection is recommended for this maintenance schedule depends on fuel quality. If there are some important safety matters like fuel flow restriction, surging, loss of power, hard starting problem, etc. replace the fuel filter immediately regardless of maintenance schedule and consult an authorized HYUNDAI dealer for details.

## Maintenance Under Severe Usage Conditions

The following items must be serviced more frequently on cars mainly used under severe driving conditions. Refer to the chart below for the appropriate maintenance intervals.

R : Replace

I : Inspect and if necessary, adjust, correct, clean or replace

Maintenance item	Maintenance operation	Maintenance intervals	Driving condition
Engine oil and engine oil filter *1	R	Replace every 5,000 miles (8,000 km) or 6 months	A, B, C, D, E, F, G, H, I, J, K, L
Air cleaner filter	R	Replace more frequently depending on the condition	C, E
Spark plugs	R	Replace more frequently depending on the condition	A, B, F, G, H, I, K
Cabin air filter	R	Replace more frequently depending on the condition	C, E, G
Disc brakes and pads, calipers and rotors	I	Inspect more frequently depending on the condition	C, D, E, G, H
Steering gear rack, linkage and boots	I	Inspect more frequently depending on the condition	C, D, E, F, G, H, I
Driveshaft and boots	I	Inspect more frequently depending on the condition	C, D, E, F, G, H, I, J
Suspension ball joints	I	Inspect more frequently depending on the condition	C, D, E, F, G
Propeller shaft	I	Inspect more frequently depending on the condition	C, D, E, F, G, H, I, J
Automatic transmission fluid	R	Replace every 60,000 miles (100,000 km)	A, C, F, G, H, I, J, K
Rear differential oil	R	Replace every 72,000 miles (120,000 km)	C, D, E, G, H, I, J
Transfer case oil (AWD)	R	Replace every 72,000 miles (120,000 km)	C, D, E, G, H, I, J
Parking brake	I	Inspect more frequently depending on the condition	C, D, G, H

### ***Severe driving conditions***

- A. Repeatedly driving short distance of less than 5 miles (8 km) in normal temperature or less than 10 miles (16 km) in freezing temperature
- B. Extensive engine idling or low speed driving for long distances
- C. Driving on rough, dusty, muddy, unpaved, graveled or salt-spread roads
- D. Driving in areas using salt or other corrosive materials or in very cold weather
- E. Driving in heavy dust conditions
- F. Driving in heavy traffic area
- G. Driving on uphill, downhill, or mountain road repeatedly
- H. Using for towing or camping, and driving with loads on the roof
- I. Driving as a patrol car, taxi, other commercial use of vehicle towing
- J. Frequently driving under high speed or rapid acceleration/deceleration
- K. Frequently driving in stop-and-go conditions
- L. Engine oil usage which is not recommended (Mineral type, Semi-synthetic, Lower grade spec, etc.)

## EXPLANATION OF SCHEDULED MAINTENANCE ITEMS

### Engine Oil and Filter

The engine oil and filter should be changed at the intervals specified in the maintenance schedule. If the vehicle is being driven in severe conditions, more frequent oil and filter changes are required.

### Drive Belts

Inspect all drive belts for evidence of cuts, cracks, excessive wear or oil saturation and replace if necessary.

Drive belts should be checked periodically for proper tension and adjusted as necessary.

### Information

**When you are inspecting the belt, turn the engine off.**

### Fuel Lines, Fuel Hoses and Connections

Check the fuel lines, fuel hoses and connections for leakage and damage. Have an authorized HYUNDAI dealer replace any damaged or leaking parts immediately.

### Vapor Hose and Fuel Filler Cap

The vapor hose and fuel filler cap should be inspected at those intervals specified in the maintenance schedule. Make sure a new vapor hose or fuel filler cap is correctly replaced.

### Air Cleaner Filter

Have the air cleaner filter replaced by an authorized HYUNDAI dealer.

### Spark Plugs

Make sure to install new spark plugs of the correct heat range.

When assembling parts, be sure to wipe out foreign substances inside and outside of the boot bottom of the ignition coil and the insulator of the spark plug with a soft cloth to prevent contamination of the spark plug insulator.

### Cooling System

Check cooling system components, such as radiator, coolant reservoir, hoses and connections for leakage and damage. Replace any damaged parts.

### Engine Coolant

The coolant should be changed at the intervals specified in the maintenance schedule.

### Automatic Transmission Fluid

The automatic transmission fluid level does not need to be checked under normal usage conditions.

Have the automatic transmission fluid changed by an authorized HYUNDAI dealer according to the maintenance schedule.

### Information

**Automatic transmission fluid color is red when new.**

**As the vehicle is driven, the automatic transmission fluid will begin to look darker.**

**This is a normal condition. It does not need to be replaced based on the color change.**

### **NOTICE**

**The use of a non-specified fluid could result in transmission malfunction and failure.**

**Use only specified automatic transmission fluid. (Refer to “Recommended Lubricants and Capacities” section in chapter 2.)**

### **Brake Hoses and Lines**

Visually check for proper installation, chafing, cracks, deterioration and any leakage. Replace any deteriorated or damaged parts immediately.

### **Brake Fluid**

Check the brake fluid level in the brake fluid reservoir. The level should be between the MIN and the MAX marks on the side of the reservoir. Use only hydraulic brake fluid conforming to DOT 4 specification.

### **Brake Discs, Pads, Calipers and Rotors**

Check the pads, the discs and the rotors for any excessive wear-out. Inspect calipers for any fluid leakage.

### **Exhaust Pipe and Muffler**

Visually inspect the exhaust pipes, muffler and hangers for cracks, deterioration, or damage. Start the engine and listen carefully for any exhaust gas leakage. Tighten connections or replace parts as necessary.

### **Propeller Shaft**

Check the propeller shaft, boots, clamps, rubber couplings and center-bearing rubber for cracks, deterioration, or damage. Replace any damaged parts and if necessary, repack the grease.

### **Suspension Mounting Bolts**

Check the suspension connections for looseness or damage. Retighten to the specified torque.

### **Steering Gear Box, Linkage & Boots/Lower Arm Ball Joint**

With the vehicle stopped and the engine off, check for excessive free-play in the steering wheel. Check the linkage for bends or damage. Check the dust boots and ball joints for deterioration, cracks, or damage.

Replace any damaged parts.

### **Drive Shafts and Boots**

Check the drive shafts, boots and clamps for cracks, deterioration, or damage. Replace any damaged parts and, if necessary, repack the grease.

### **Air Conditioning Refrigerant**

Check the air conditioning lines and connections for leakage and damage.

## ENGINE OIL

### Checking the Engine Oil Level

Engine oil is used for lubricating, cooling, and operating various hydraulic components in the engine. Engine oil consumption while driving is normal, and it is necessary to check and refill the engine oil regularly. Also, check and refill the oil level within the recommended maintenance schedule to prevent deterioration of oil performance.

Check the engine oil following the below procedure.

1. Follow all of the oil manufacturer's precautions.
2. Be sure the vehicle is on the level ground in P (Park) with the parking brake set and the wheels blocked.
3. Turn the engine on and warm the engine up until the coolant temperature reaches a constant normal temperature.
4. Turn the engine off, remove the oil filler cap and pull the dipstick out. Wait for 15 minutes for the oil to return to the oil pan.
5. Wipe the dipstick clean and re-insert it fully.



6. Pull the dipstick out again and check the level. The level should be between F (Full) and L (Low).
7. If the oil level is below L, add enough oil to bring the level to F.

Use only the specified engine oil (Refer to “Recommended Lubricants and Capacities” section in chapter 2).

**NOTICE**

To prevent damage to your engine:

- Do not spill engine oil when adding or changing engine oil. Wipe off spilled oil immediately.
- The engine oil consumption may increase while you break in a new vehicle and it will be stabilized after driving 4000 miles (6000 km).
- The engine oil consumption can be affected by driving habits, climate conditions, traffic conditions, oil quality, etc. Therefore, it is recommended that you inspect the engine oil level regularly and refill it if necessary.

**Checking the Engine Oil and Filter**



- Have engine oil and filter changed by an authorized HYUNDAI dealer according to the Maintenance Schedule at the beginning of this chapter.
- If the maintenance schedule to replace engine oil is exceeded, the engine oil performance may deteriorate, and the engine condition may be affected. Therefore, replace the engine oil according to the maintenance schedule.
- To keep the engine in optimal condition, use the recommended engine oil and filter. If the recommended engine oil and filter are not used, replace it according to the maintenance schedule under severe usage conditions.
- The purpose of the maintenance schedule for engine oil replacement is to prevent oil deterioration and it is irrelevant to oil consumption. Check and refill engine oil regularly.

**CAUTION**

The engine oil is very hot immediately after the vehicle has been driven and can cause burns during replacement. Replace the engine oil after the engine oil has cooled down.

**WARNING**

Used engine oil may cause irritation or cancer of the skin if left in contact with the skin for prolonged periods of time. Used engine oil contains chemicals that have caused cancer in laboratory animals. Always protect your skin by washing your hands thoroughly with soap and warm water as soon as possible after handling used oil.

**WARNING****CALIFORNIA PROPOSITION 65  
WARNING**

Engine oil contains chemicals known to the State of California to cause cancer, birth defects and reproductive harm.

Used engine oil may cause irritation or cancer of the skin if left in contact with the skin for prolonged periods of time.

Always protect your skin by washing your hands thoroughly with soap and warm water as soon as possible after handling used oil.



## ENGINE COOLANT

The high-pressure cooling system has a reservoir filled with year-round antifreeze coolant. The reservoir is filled at the factory.

Check the antifreeze protection and coolant level at least once a year, at the beginning of the winter season and before traveling to a colder climate.

### Checking the Coolant Level

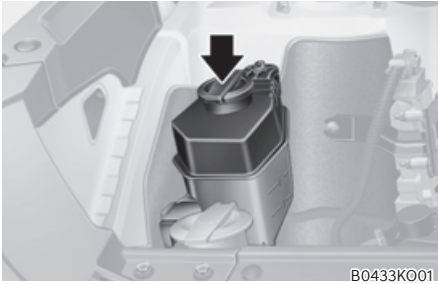

Check the condition and connections of all cooling system hoses and heater hoses. Replace any swollen or deteriorated hoses.

The coolant level should be filled between the F and the L marks on the side of the coolant reservoir when the engine is cool.

If the coolant level is low, add enough distilled (deionized) water to bring the level to the F mark, but do not overfill. If frequent additions are required, see an authorized HYUNDAI dealer for a cooling system inspection.

### WARNING

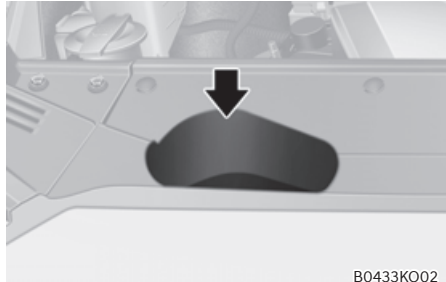

**Never remove the engine coolant cap and/or the drain plug while the engine and radiator are hot. Hot coolant and steam may blow out under pressure, causing serious injury.**

**Turn the vehicle off and wait until the engine cools down. Use extreme care when removing the engine coolant cap. Wrap a thick towel around it, and turn it counterclockwise slowly. Step back while the pressure is released from the cooling system. When you are sure all the pressure has been released, using a thick towel, and continue turning counterclockwise to remove it.**

## **i** Information

The coolant level is influenced by the engine temperature. Before checking or refilling the coolant, turn the engine off.

## **!** WARNING



The electric motor for the cooling fan may continue to operate or start up when the engine is not running and can cause serious injury. Keep hands, clothing and tools away from the rotating fan blades of the cooling fan.

Always turn off the vehicle unless the vehicle has to be inspected with the engine on. Be cautious as the cooling fan may operate if the negative (-) battery terminal is not disconnected.

## **!** WARNING

Make sure the coolant cap is properly closed after refilling coolant. Otherwise the engine could be overheated whilst driving.



B0433EE01

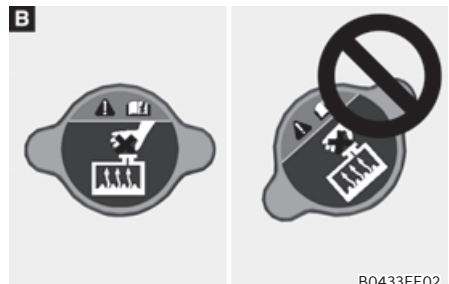

B0433EE02

1. Check if the coolant cap label is straight in front.



B0433EE03

2. Make sure that the tiny protrusions inside the coolant cap is securely interlocked.

**Recommended coolant**

- When adding coolant, use only deionized water, distilled water or soft water for your vehicle and never mix hard water in the coolant filled at the factory.
- An incorrect coolant mixture can result in severe malfunction or engine damage.
- The engine in your vehicle has aluminum engine parts and must be protected by a phosphate-based ethylene glycol coolant to prevent corrosion and freezing.
- Do not use alcohol or methanol coolant or mix them with the specified coolant.
- Do not use a solution that contains more than 60% antifreeze or less than 35% antifreeze, which would reduce the effectiveness of the solution.

For mixing percentage, refer to the following table:

Ambient Temperature	Mixture Percentage (volume)	
	Antifreeze	Water
5°F (-15°C)	35	65
-13°F (-25°C)	40	60
-31°F (-35°C)	50	50
-49°F (-45°C)	60	40

**i Information**

If in doubt about the mix ratio, a 50% water and 50% antifreeze mix is the easiest to mix together as it will be the same quantity of each. It is suitable to use for most temperature ranges of -31°F (-35°C) and higher.

**Changing Coolant**

Have coolant changed by an authorized HYUNDAI dealer according to the Maintenance Schedule at the beginning of this chapter.

**⚠ WARNING**

**Do not use engine coolant or antifreeze in the washer fluid reservoir.**

**Engine coolant can severely obscure visibility when sprayed on the windshield and may cause loss of vehicle control resulting in an accident.**

**Engine coolant may also cause damage to paint and body trim.**

**NOTICE**

**To prevent damage to engine parts, put a thick towel around the engine coolant cap before refilling the coolant to prevent the coolant from overflowing into engine parts, such as the alternator.**

## BRAKE FLUID

### Checking the Brake Fluid Level

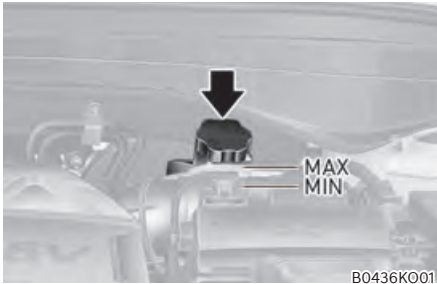

B0436K001

Check the fluid level in the reservoir periodically. The fluid level should be between MAX and MIN marks on the side of the reservoir.

Before removing the reservoir cap and adding brake fluid, clean the area around the reservoir cap thoroughly to prevent brake fluid contamination.

If the level is low, add fluid to the MAX level. The level will fall with accumulated mileage. This is a normal condition associated with the wear of the brake linings.

If the fluid level is excessively low, have the system be checked by an authorized HYUNDAI dealer.

### WARNING

If the brake system requires frequent additions of fluid this could indicate a leak in the brake system. Have the vehicle inspected by an authorized HYUNDAI dealer.

### WARNING

Do not allow brake fluid to come in contact with your eyes. If brake fluid comes in contact with your eyes, flush your eyes with clean water for at least 15 minutes and get immediate medical attention.

### **NOTICE**

- Do not allow brake fluid to contact the vehicle's body paint, as paint damage will result.
- Brake fluid, which has been exposed to open air for an extended time should NEVER be used as its quality cannot be guaranteed. It should be disposed of properly.
- Do not use the incorrect type of brake fluid. A few drops of mineral based oil, such as engine oil, in your brake system can damage brake system parts.

### Information

Use only the specified brake fluid (refer to “Recommended Lubricants and Capacities” section in chapter 2).

## WASHER FLUID

### Checking the Washer Fluid Level



B0439K001

Check the fluid level in the washer fluid reservoir and add fluid if necessary. Plain water may be used if washer fluid is not available. However, use washer solvent with antifreeze characteristics in cold climates to prevent freezing.

### **WARNING**

To prevent serious injury or death, take the following safety precautions when using washer fluid:

- Do not use engine coolant or antifreeze in the washer fluid reservoir. Engine coolant can severely obscure visibility when sprayed on the windshield and may cause loss of vehicle control resulting in an accident or damage to paint and body trim.
- Do not allow sparks or flame to contact the washer fluid or the washer fluid reservoir. Washer fluid may contain alcohol and can be flammable.
- Do not drink washer fluid and avoid contact with skin. Washer fluid is harmful to humans and animals.
- Keep washer fluid away from children and animals.

## AIR CLEANER

### Filter Replacement

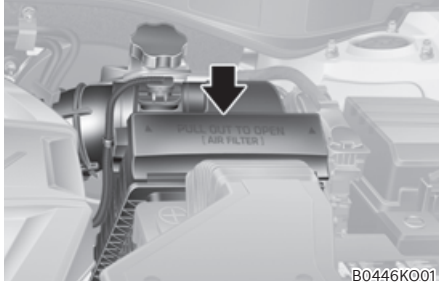

B0446K001

The air cleaner filter can be cleaned for inspection using compressed air.

Do not attempt to wash or to rinse it, as water will damage the filter.

If soiled, the air cleaner filter must be replaced.

Replace the filter according to the Maintenance Schedule.

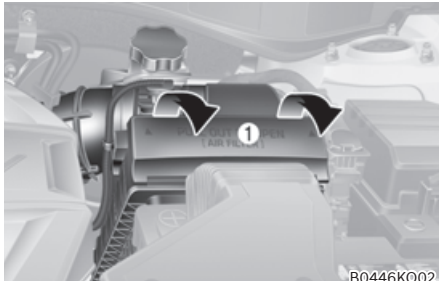

B0446K002

1. Pull down the air cleaner filter cover ①.

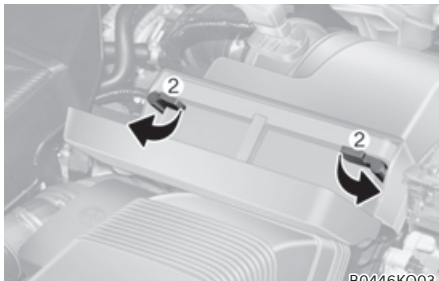

B0446K003

2. Pull down the lever ② to the UNLOCK position.



B0446K004

3. Replace the air cleaner filter.
4. Reassemble the air cleaner cover in the reverse order.
5. Check that the cover is firmly installed.

### **i** Information

If the vehicle is operated in extremely dusty or sandy areas, replace the air cleaner filter more often than the usual recommended intervals (Refer to “Maintenance Under Severe Usage Conditions” section in this chapter).

### **NOTICE**

- Do not drive with the air cleaner filter removed. This will result in excessive engine wear.
- When removing the air cleaner filter, be careful that dust or dirt does not enter the air intake, or damage may result.
- Use HYUNDAI genuine parts. Use of non-genuine parts could damage the engine.
- Do not blow the inner part of the air filter with compressed air. Dust or dirt may enter the air intake.
- Check that the replaced filter is firmly fixed when reassembling the air cleaner filter, and that the clamps are firmly assembled.

## CABIN AIR FILTER

### Filter Inspection

The cabin air filter should be replaced according to the Maintenance Schedule. If the vehicle is operated in severely air-polluted cities or on dusty rough roads for a long period, it should be inspected more frequently and replaced sooner. Replace the cabin air filter by following the procedure below and be careful to avoid damaging other components.

### Filter Replacement

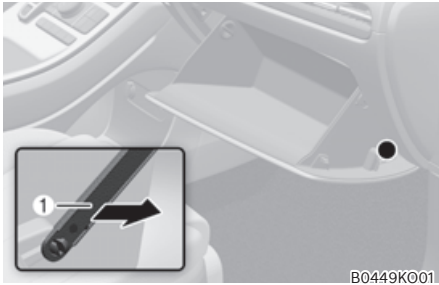

1. Open the glove box and remove the support rod ①.

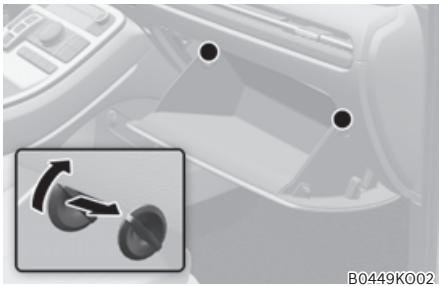

2. Remove the stoppers on both sides to allow the glove box to hang freely on the hinges.

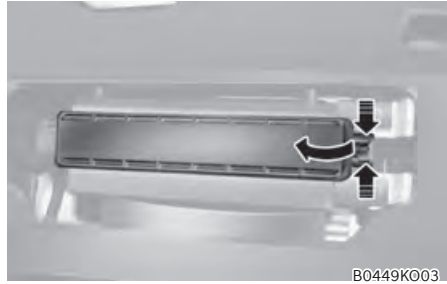

3. Press and hold the lock on the left side of the cover.
4. Pull out ② the cover.
5. Replace the cabin air filter.
6. Reassemble in the reverse order of disassembly.

### NOTICE

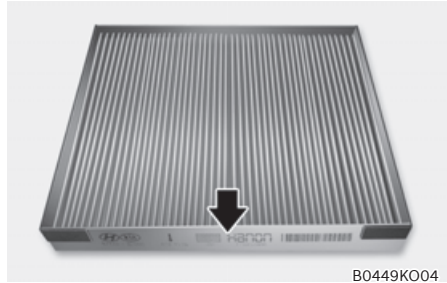

**Install a new cabin air filter in the correct direction with the arrow symbol (↓) facing downwards, to prevent noise and reduce effectiveness.**

## WIPER BLADES

### Blade Inspection

Contamination of either the windshield or the wiper blades with foreign matter can reduce the effectiveness of the windshield wipers.

Common sources of contamination are insects, tree sap, and hot wax treatments used by some commercial car washes. If the blades are not wiping properly, clean both the window and the blades with a good cleaner or mild detergent, and rinse thoroughly with clean water.

### NOTICE

To prevent damage to the wiper blades, arms or other components, do not:

- Use gasoline, kerosene, paint thinner, or other solvents on or near them.
- Attempt to move the wipers manually.
- Use non-specified wiper blades.

### **i** Information

Commercial hot waxes applied by automatic car washes have been known to make the windshield difficult to clean.

### **i** Information

Wiper blades are consumable items. Normal wear of the wipers may not be covered by your vehicle warranty.

### Blade Replacement

When the wipers no longer clean adequately, the blades may be worn or cracked, and require replacement.

### NOTICE

- In order to prevent damage to the hood and the wiper arms, the wiper arms should only be lifted when in the top wiping position.
- Always return the wiper arms to the windshield before driving.

### Front windshield wiper blade replacement

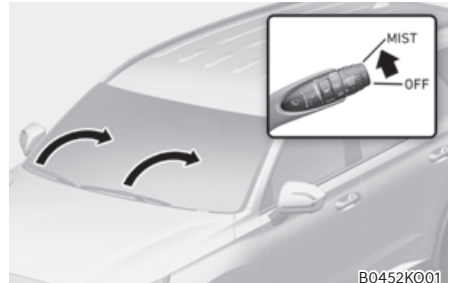

1. Within 20 seconds of turning off the engine, lift up and hold the wiper lever to the MIST position for about 2 seconds until the wipers move to the top wipe position.
2. At this time you can lift the wipers off the windshield.

### **i** Information

This vehicle has a “hidden” wiper design which means that the wipers cannot be lifted manually when they are in their bottom resting position.

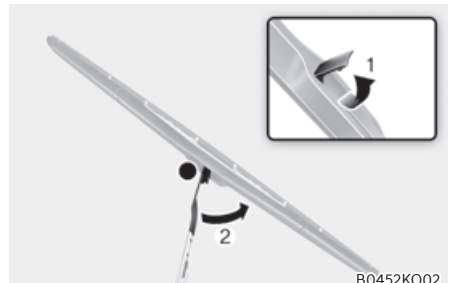

3. Lift up the wiper blade clip ①. Then lift up the wiper blade ②.



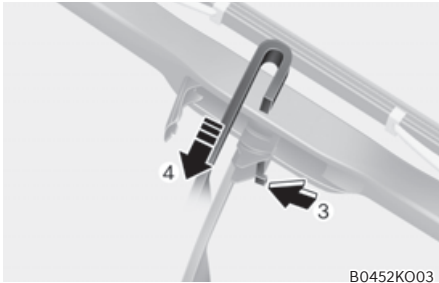

4. While pushing the lock ③, pull down the wiper blade ④.

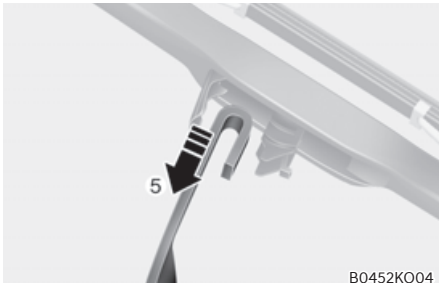

5. Remove the wiper blade from the wiper arm ⑤.
6. Install a new wiper blade assembly in the reverse order of removal.
7. Gently put the wipers back down onto the windshield.
8. With the ignition switch or Engine Start/Stop button in the ON position, turn the wiper switch to any ON position to return the wipers to the bottom resting position.

### Rear window wiper blade replacement

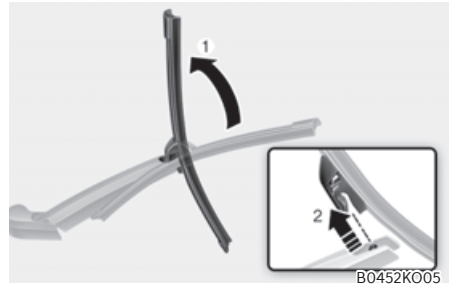

1. Raise the wiper arm and then rotate the wiper blade assembly ①.
2. Pull out the wiper blade assembly ②.

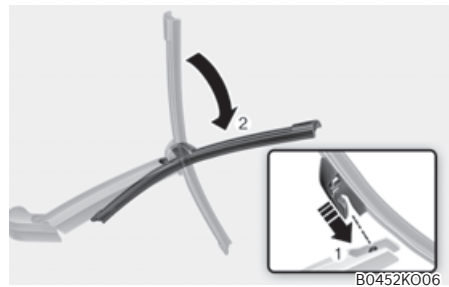

3. Install the new blade assembly by inserting the center part into the slot in the wiper arm until it clicks into place ③.
4. Make sure the blade assembly is installed firmly by trying to pull it slightly.
5. Rotate back the blade assembly so that it aligns with the wiper arm.

To prevent damage to the wiper arms or other components, have the wiper blades replaced by an authorized HYUNDAI dealer.

## BATTERY



### WARNING

To prevent **SERIOUS INJURY** or **DEATH** to you or bystanders, always follow these precautions when working near or handling the battery:



Always read and follow instructions carefully when handling a battery.



Wear eye protection designed to protect the eyes from acid splashes.



Keep all flames, sparks, or smoking materials away from the battery.



Hydrogen is always present in battery cells, is highly combustible, and may explode if ignited.



Keep batteries out of reach of children.



Batteries contain sulfuric acid which is highly corrosive. Do not allow acid to contact your eyes, skin or clothing.

If acid gets into your eyes, flush your eyes with clean water for at least 15 minutes and get immediate medical attention. If acid gets on your skin, thoroughly wash the area. If you feel pain or a burning sensation, get medical attention immediately.

- When lifting a plastic-cased battery, excessive pressure on the case may cause battery acid to leak. Lift with a battery carrier or with your hands on opposite corners.
- Do not attempt to jump start your vehicle if your battery is frozen.
- **NEVER** attempt to recharge the battery when the vehicle's battery cables are connected to the battery.
- The electrical ignition system works with high voltage. **NEVER** touch these components with the engine running or when the Engine Start/ Stop button is in the ON position.



### WARNING

#### CALIFORNIA PROPOSITION 65 WARNING

Battery posts, terminals, and related accessories contain lead and lead compounds, chemicals known to the State of California to cause cancer, birth defects and reproductive harm. Batteries also contain other chemicals known to the State of California to cause cancer. Wash hands after handling.

## NOTICE

Always follow these instructions when handling your vehicle's battery to prevent damage to your battery:

- When you do not use the vehicle for a long time in a low temperature area, disconnect the battery and keep it indoors.
- Always charge the battery fully to prevent battery case damage in low temperature areas.
- Prevent liquid from wetting the battery terminals. The performance of the battery may be degraded, and may cause injury. Be cautious when loading liquid in the liftgate.
- Do not tilt the battery.
- If you connect unauthorized electronic devices to the battery, the battery may be discharged. Never use unauthorized devices.

## For Best Battery Service

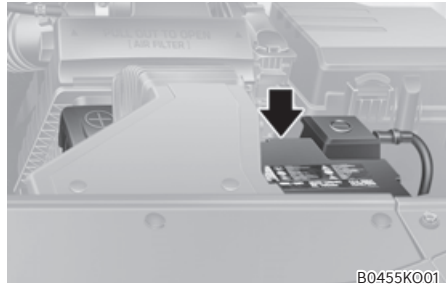

- Keep the battery securely mounted.
- Keep the battery top clean and dry.
- Keep the terminals and connections clean, tight, and coated with petroleum jelly or terminal grease.
- Rinse any spilled acid from the battery immediately with a solution of water and baking soda.

## **i** Information

For vehicles with power liftgate, note that the power liftgate needs to be reset after the battery has been replaced. For more details, refer to “Power Liftgate” section in chapter 5.

## Battery Capacity Label

■ Example



B1300EU01

\* The actual battery label in the vehicle may differ from the illustration.

1. AGM80L-DIN: The HYUNDAI modelname of battery
2. 12V: The nominal voltage
3. 80Ah (20HR): The nominal capacity(in Ampere hours)
4. RC 155min: The nominal reservecapacity (in min.)
5. CCA 800A (SAE/EN): The cold testcurrent in amperes

## Battery Recharging

### WARNING

Always follow these instructions when recharging your vehicle's battery to avoid the risk of **SERIOUS INJURY** or **DEATH** from explosions or acid burns:

- Before performing maintenance or recharging the battery, turn off all accessories and stop the engine.
- Keep all flames, sparks, or smoking materials away from the battery.
- Always work outdoors or in an area with plenty of ventilation.
- Wear eye protection when checking the battery during charging.
- The battery must be removed from the vehicle and placed in a well ventilated area.
- Watch the battery during charging, and stop or reduce the charging rate if the battery cells begin boiling violently.
- The negative battery cable must be removed first and installed last when the battery is disconnected. Disconnect the battery charger in the following order:
  1. Turn off the battery charger main switch.
  2. Unhook the negative clamp from the negative battery terminal.
  3. Unhook the positive clamp from the positive battery terminal.
- Always use a Genuine HYUNDAI dealer approved battery when you replace the battery.

## NOTICE

### AGM battery (if equipped)

- **Absorbent Glass Matt (AGM) batteries are maintenance-free and have the AGM battery be serviced by an authorized HYUNDAI dealer. For charging your AGM battery, use only fully automatic battery chargers that are specially developed for AGM batteries.**
- **When replacing the AGM battery, have you use parts for replacement from an authorized HYUNDAI dealer.**
- **Do not open or remove the cap on top of the battery. This may cause leaks of internal electrolyte that could result in severe injury.**

### *By jump starting*

After a jump start from a good battery, drive the vehicle for 20-30 minutes before it is shutoff. The vehicle may not restart if you shut it off before the battery had a chance to adequately recharge. See “Jump Starting” in chapter 8 for more information on jump starting procedures.



## Information



**An inappropriately disposed battery can be harmful to the environment and human health. Dispose of the battery according to your local law(s) or regulation.**

## Reset Items

The following items may need to be reset after the battery has been discharged or the battery has been disconnected.

- Driving info/Since refueling/Accumulated info (see chapter 4)
- Integrated memory system (see chapter 5)
- Power window (see chapter 5)
- Sunroof (see chapter 5)
- Climate control system (see chapter 5)
- Clock (see Infotainment system manual)

## TIRES AND WHEELS



### WARNING

Tire failure may cause loss of vehicle control resulting in an accident. To reduce risk of **SERIOUS INJURY** or **DEATH**, take the following precautions:

- Inspect your tires monthly for proper inflation as well as wear and damage.
- The recommended cold tire pressure for your vehicle can be found in this manual and on the tire label located on the driver's side center pillar. Always use a tire pressure gauge to measure tire pressure. Tires with too much or too little pressure wear unevenly causing poor handling.
- Check the pressure of the spare every time you check the pressure of the other tires on your vehicle.
- Replace tires that are worn, show uneven wear, or are damaged. Worn tires can cause loss of braking effectiveness, steering control, or traction.
- **ALWAYS** replace tires with the same size, type, construction and tread pattern as each tire that was originally supplied with this vehicle. Using tires and wheels other than the recommended sizes could cause unusual handling characteristics, poor vehicle control, or negatively affect your vehicle's Anti-Lock Brake System (ABS) resulting in a serious accident.

### Tire Care

For proper maintenance, safety, and maximum fuel economy, you must always maintain recommended tire inflation pressures and stay within the load limits and weight distribution recommended for your vehicle.

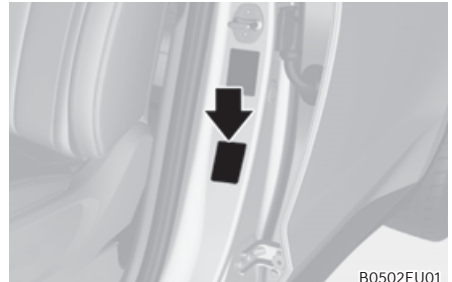

B0502EU01

All specifications (sizes and pressures) can be found on a label attached to the driver's side center pillar.

### Recommended Cold Tire Inflation Pressures

All tire pressures (including the spare) should be checked when the tires are cold. "Cold tires" means the vehicle has not been driven for at least three hours or driven less than one mile (1.6 km).

Warm tires normally exceed recommended cold tire pressures by 4 to 6 psi (28 to 41 kPa). Do not release air from warm tires to adjust the pressure or the tires will be under-inflated. For recommended inflation pressure, refer to "Tire and Wheels" section in chapter 2.



## WARNING

**Recommended pressures must be maintained for the best ride, vehicle handling, and minimum tire wear.**

**Over-inflation or under-inflation can reduce tire life, adversely affect vehicle handling, and lead to sudden tire failure that could result in loss of vehicle control resulting in an accident.**

**Severe under-inflation can lead to severe heat build-up, causing blowouts, tread separation and other tire failures that can result in the loss of vehicle control resulting in an accident. This risk is much higher on hot days and when driving for long periods at high speeds.**



## CAUTION

- **Under-inflation results in excessive wear, poor handling and reduced fuel economy. Wheel deformation is also possible. Keep your tire pressures at the proper levels. If a tire frequently needs refilling, have it checked by an authorized HYUNDAI dealer.**
- **Over-inflation produces a harsh ride, excessive wear at the center of the tire tread, and a greater possibility of damage from road hazards.**

## Check Tire Inflation Pressure

Check your tires, including the spare tire, once a month or more.

### *How to check*

Use a good quality tire pressure gauge to check tire pressure. You can not tell if your tires are properly inflated simply by looking at them. Radial tires may look properly inflated when they are under-inflated.

Remove the valve cap from the tire valve stem. Press the tire gauge firmly onto the valve to get a pressure measurement. If the cold tire inflation pressure matches the recommended pressure on the tire and loading information label, no further adjustment is necessary. If the pressure is low, add air until you reach the recommended pressure. Make sure to put the valve caps back on the valve stems. Without the valve cap, dirt or moisture could get into the valve core and cause air leakage. If a valve cap is missing, install a new one as soon as possible. If you overfill the tire, release air by pushing on the metal stem in the center of the tire valve. Recheck the tire pressure with the tire gauge. Be sure to put the valve caps back on the valve stems. Without the valve cap, dirt or moisture could get into the valve core and cause air leakage. If a valve cap is missing, install a new one as soon as possible.

## Tire Rotation

To equalize tread wear, HYUNDAI recommends that the tires be rotated according to the maintenance schedule or sooner if irregular wear develops.

During rotation, check the tires for correct balance.

When rotating tires, check for uneven wear and damage. Abnormal wear is usually caused by incorrect tire pressure, improper wheel alignment, out-of-balance wheels, severe braking or severe cornering. Look for bumps or bulges in the tread or side of the tire. Replace the tire if you find any of these conditions. Replace the tire if fabric or cord is visible. After rotation, be sure to bring the front and rear tire pressures to specification and check lug nut tightness (proper torque is 79–94 lbf·ft [11–13 kgf·m]).

### ■ Without a spare tire

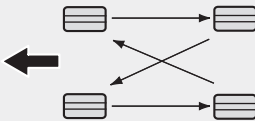

S2BLA790A

### ■ Directional tires (if equipped)

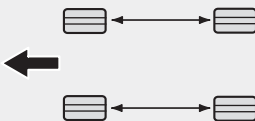

CBGQ0707A

Disc brake pads should be inspected for wear whenever tires are rotated.

## **i** Information

The outside and inside of the unsymmetrical tire is distinguishable. When installing an unsymmetrical tire, be sure to install the side marked “outside” face the outside. If the side marked “inside” is installed on the outside, it will have a negative effect on vehicle performance.

## **!** WARNING

- Do not use the compact spare tire for tire rotation.
- Do not mix bias ply and radial ply tires under any circumstances. This may cause unusual handling characteristics that may cause loss of vehicle control resulting in an accident.



## Wheel Alignment and Tire Balance

The wheels on your vehicle were aligned and balanced carefully at the factory to give you the longest tire life and best overall performance.

In most cases, you will not need to have your wheels aligned again. However, if you notice unusual tire wear or your vehicle pulling one way or the other, the alignment may need to be reset.

If you notice your vehicle vibrating when driving on a smooth road, your wheels may need to be rebalanced.

### NOTICE

**Incorrect wheel weights can damage your vehicle's aluminum wheels. Use only approved wheel weights.**

## Tire Replacement

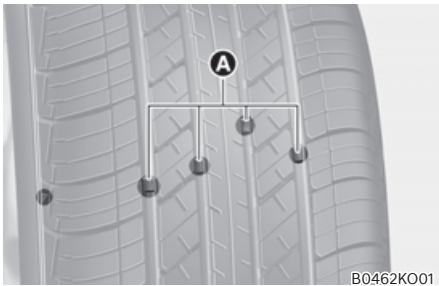

Ⓐ: Tread wear indicator

If the tire is worn evenly, a tread wear indicator will appear as a solid band across the tread. This shows there is less than 1/16 inch (1.6 mm) of tread left on the tire. Replace the tire when this happens.

Do not wait for the band to appear across the entire tread before replacing the tire.

### ⚠ WARNING

**To reduce the risk of DEATH or SERIOUS INJURY:**

- **Replace tires that are worn, show uneven wear, or are damaged. Worn tires can cause loss of braking effectiveness, steering control, and traction.**
- **Always replace tires with the same size as each tire that was originally supplied with this vehicle. Using tires and wheels other than the recommended sizes could cause unusual handling characteristics, poor vehicle control, or negatively affect your vehicle's Anti-Lock Brake System (ABS) resulting in a serious accident.**
- **When replacing tires (or wheels), it is recommended to replace the two front or two rear tires (or wheels) as a pair. Replacing just one tire can seriously affect your vehicle's handling.**
- **Tires degrade over time, even when they are not being used. Regardless of the remaining tread, HYUNDAI recommends that tires be replaced after six (6) years of normal service.**
- **Heat caused by hot climates or frequent high loading conditions can accelerate the aging process. Failure to follow this warning may cause sudden tire failure, which could lead to a loss of vehicle control resulting in an accident.**

### ***Compact spare tire replacement (if equipped)***

A compact spare tire has a shorter tread life than a regular size tire. Replace it when you can see the tread wear indicator bars on the tire. The replacement compact spare tire should be the same size and design tire as the one provided with your new vehicle and should be mounted on the same compact spare tire wheel. The compact spare tire is not designed to be mounted on a regular size wheel, and the compact spare tire wheel is not designed for mounting a regular size tire.



### **WARNING**

**The original tire should be repaired or replaced as soon as possible to avoid failure of the spare and loss of vehicle control resulting in an accident. The compact spare tire is for emergency use only. Do not operate your vehicle over 50 mph (80 km/h) when using the compact spare tire.**

### **Wheel Replacement**

When replacing the metal wheels for any reason, make sure the new wheels are equivalent to the original factory units in diameter, rim width and offset.

### **Tire Traction**

Tire traction can be reduced if you drive on worn tires, tires that are improperly inflated or on slippery road surfaces. Tires should be replaced when tread wear indicators appear. To reduce the possibility of losing control, slow down whenever there is rain, snow or ice on the road.

### **Tire Maintenance**

In addition to proper inflation, correct wheel alignment helps to decrease tire wear. If you find a tire is worn unevenly, have your dealer check the wheel alignment.

When you have new tires installed, make sure they are balanced. This will increase vehicle ride comfort and tire life. Additionally, a tire should always be rebalanced if it is removed from the wheel.

## Tire Sidewall Labeling

This information identifies and describes the fundamental characteristics of the tire and also provides the tire identification number (TIN) for safety standard certification. The TIN can be used to identify the tire in case of a recall.

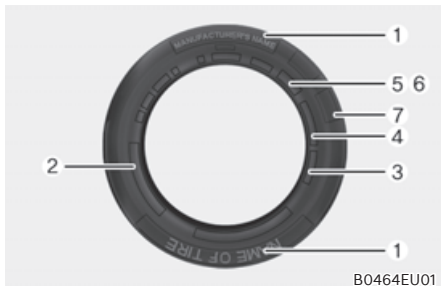

### 1. **Manufacturer or brand name**

Manufacturer or brand name is shown.

### 2. **Tire size designation**

A tire's sidewall is marked with a tire size designation. You will need this information when selecting replacement tires for your car. The following explains what the letters and numbers in the tire size designation mean.

Example tire size designation:

(These numbers are provided as an example only; your tire size designator could vary depending on your vehicle.)

### **245/60 R18 105H**

245 - Tire width in millimeters.

60 - Aspect ratio. The tire's section height as a percentage of its width.

R - Tire construction code (Radial).

18 - Rim diameter in inches.

105 - Load Index, a numerical code associated with the maximum load the tire can carry.

H - Speed Rating Symbol. See the speed rating chart in this section for additional information.

### **Wheel size designation**

Wheels are also marked with important information that you need if you ever have to replace one. The following explains what the letters and numbers in the wheel size designation mean.

Example wheel size designation:

### **7.5J X 18**

7.5 - Rim width in inches.

J - Rim contour designation.

18 - Rim diameter in inches.

### Tire speed ratings

The chart below lists many of the different speed ratings currently being used for passenger vehicle tires. The speed rating is part of the tire size designation on the sidewall of the tire. This symbol corresponds to that tire's designed maximum safe operating speed.

Speed Rating Symbol	Maximum Speed
S	112 mph (180 km/h)
T	118 mph (190 km/h)
H	130 mph (210 km/h)
V	149 mph (240 km/h)
W	168 mph (270 km/h)
Y	186 mph (300 km/h)

### 3. Checking tire life (TIN : Tire Identification Number)

Any tires that are over six years old, based on the manufacturing date, (including the spare tire) should be replaced by new ones. You can find the manufacturing date on the tire sidewall (possibly on the inside of the wheel), displaying the DOT Code. The DOT Code is a series of numbers on a tire consisting of numbers and English letters. The manufacturing date is designated by the last four digits (characters) of the DOT code.

### DOT : XXXX XXXX OOOO

The front part of the DOT shows a plant code number, tire size and tread pattern and the last four numbers indicate week and year manufactured.

For example:

DOT XXXX XXXX 1522 represents that the tire was produced in the 15th week of 2022.

### 4. Tire ply composition and material

The number of layers or plies of rubber-coated fabric in the tire. Tire manufacturers also must indicate the materials in the tire, which include steel, nylon, polyester, and others. The letter "R" means radial ply construction; the letter "D" means diagonal or bias ply construction; and the letter "B" means belted-bias ply construction.

### **5. Maximum permissible inflation pressure**

This number is the greatest amount of air pressure that should be put in the tire. Do not exceed the maximum permissible inflation pressure. Refer to the Tire and Loading Information label for recommended inflation pressure.

### **6. Maximum load rating**

This number indicates the maximum load in kilograms and pounds that can be carried by the tire. When replacing the tires on the vehicle, always use a tire that has the same load rating as the factory installed tire.

### **7. Uniform tire quality grading**

Quality grades can be found where applicable on the tire sidewall between tread shoulder and maximum section width.

For example:  
TREADWEAR 200  
TRACTION AA  
TEMPERATURE A

### **Tread wear**

The tread wear grade is a comparative rating based on the wear rate of the tire when tested under controlled conditions on a specified government test course. For example, a tire graded 150 would wear one-and-a-half times (1½) as well on the government course as a tire graded 100.

The relative performance of tires depends upon the actual conditions of their use, however, and may depart significantly from the norm due to variations in driving habits, service practices and differences in road characteristics and climate.

These grades are molded on the sidewalls of passenger vehicle tires. The tires available as standard or optional equipment on your vehicle may vary with respect to grade.

### **Traction - AA, A, B & C**

The traction grades, from highest to lowest, are AA, A, B and C. Those grades represent the tire's ability to stop on wet pavement as measured under controlled conditions on specified government test surfaces of asphalt and concrete. A tire marked C may have poor traction performance.



### **WARNING**

**The traction grade assigned to this tire is based on straight ahead braking traction tests, and does not include acceleration, cornering, hydroplaning, or peak traction characteristics.**

### Temperature - A, B & C

The temperature grades are A (the highest), B and C representing the tire's resistance to the generation of heat and its ability to dissipate heat when tested under controlled conditions on a specified indoor laboratory test wheel.

Sustained high temperature can cause the material of the tire to degenerate and reduce tire life, and excessive temperature can lead to sudden tire failure. Grades B and A represent higher levels of performance on the laboratory test wheel than the minimum required by law.



### **WARNING**

**The temperature grade for this tire is established for a tire that is properly inflated and not overloaded. Excessive speed, under-inflation, over-inflation, or excessive loading, either separately or in combination, can cause heat build-up and possible sudden tire failure. This may cause loss of vehicle control resulting in an accident.**

## Tire Terminology and Definitions

### ***Air pressure***

The amount of air inside the tire pressing outward on the tire. Air pressure is expressed in pounds per square inch (psi) or kilopascal (kPa).

### ***Accessory weight***

This means the combined weight of optional accessories. Some examples of optional accessories are automatic transmission, power seats, and air conditioning.

### ***Aspect ratio***

The relationship of a tire's height to its width.

### ***Belt***

A rubber coated layer of cords that is located between the plies and the tread. Cords may be made from steel or other reinforcing materials.

### ***Bead***

The tire bead contains steel wires wrapped by steel cords that hold the tire onto the rim.

***Bias ply tire***

A pneumatic tire in which the plies are laid at alternate angles less than 90 degrees to the centerline of the tread.

***Cold tire pressure***

The amount of air pressure in a tire, measured in pounds per square inch (psi) or kilopascals (kPa) before a tire has built up heat from driving.

***Curb weight***

This means the weight of a motor vehicle with standard and optional equipment including the maximum capacity of fuel, oil and coolant, but without passengers and cargo.

***DOT markings***

A code molded into the sidewall of a tire signifying that the tire is in compliance with the U.S. Department of Transportation motor vehicle safety standards. The DOT code includes the Tire Identification Number (TIN), an alphanumeric designator which can also identify the tire manufacturer, production plant, brand and date of production.

***GVWR***

Gross Vehicle Weight Rating

***GAWR FRT***

Gross Axle Weight Rating for the Front Axle.

***GAWR RR***

Gross Axle Weight Rating for the Rear axle.

***Intended outboard sidewall***

The side of an asymmetrical tire, that must always face outward when mounted on a vehicle.

***Kilopascal (kPa)***

The metric unit for air pressure.

***Light Truck (LT) tire***

A tire designated by its manufacturer as primarily intended for use on lightweight trucks or multipurpose passenger vehicles.

***Load ratings***

The maximum load that a tire is rated to carry for a given inflation pressure.

***Load index***

An assigned number ranging from 1 to 279 that corresponds to the load carrying capacity of a tire.

***Maximum inflation pressure***

The maximum air pressure to which a cold tire may be inflated. The maximum air pressure is molded onto the sidewall.

***Maximum load rating***

The load rating for a tire at the maximum permissible inflation pressure for that tire.

**Maximum loaded vehicle weight**

The sum of curb weight; accessory weight; vehicle capacity weight; and production options weight.

**Normal occupant weight**

The number of occupants a vehicle is designed to seat multiplied by 150 pounds (68 kg).

**Occupant distribution**

Designated seating positions.

**Outward facing sidewall**

An asymmetrical tire has a particular side that faces outward when mounted on a vehicle. The outward facing sidewall bears white lettering or bears manufacturer, brand, and/or model name molding that is higher or deeper than the same moldings on the inner facing sidewall.

**Passenger (P-Metric) tire**

A tire used on passenger cars and some light duty trucks and multipurpose vehicles.

**Ply**

A layer of rubber-coated parallel cords.

**Pneumatic tire**

A mechanical device made of rubber, chemicals, fabric and steel or other materials, that, when mounted on an automotive wheel provides the traction and contains the gas or fluid that sustains the load.

**Pneumatic options weight**

The combined weight of installed regular production options weighing over 5 lb. (2.3 kg) in excess of the standard items which they replace, not previously considered in curb weight or accessory weight, including heavy duty breaks, ride levelers, roof rack, heavy duty battery, and special trim.

**Recommended inflation pressure**

Vehicle manufacturer's recommended tire inflation pressure as shown on the tire placard.

**Radial ply tire**

A pneumatic tire in which the ply cords that extend to the beads are laid at 90 degrees to the centerline of the tread.

**Rim**

A metal support for a tire and upon which the tire beads are seated.

**Sidewall**

The portion of a tire between the tread and the bead.

**Speed rating**

An alphanumeric code assigned to a tire indicating the maximum speed at which a tire can operate.



### ***Traction***

The friction between the tire and the road surface. The amount of grip provided.

### ***Tread***

The portion of a tire that comes into contact with the road.

### ***Treadwear indicators***

Narrow bands, sometimes called “wear bars”, that show across the tread of a tire when only 1/16 inch of tread remains.

### ***UTQGS***

Uniform Tire Quality Grading Standards is a tire information system that provides consumers with ratings for a tire’s traction, temperature and treadwear. Ratings are determined by tire manufacturers using government testing procedures. The ratings are molded into the sidewall of the tire.

### ***Vehicle capacity weight***

The number of designated seating positions multiplied by 150 lbs. (68 kg) plus the rated cargo and luggage load.

### ***Vehicle maximum load on the tire***

Load on an individual tire due to curb and accessory weight plus maximum occupant and cargo weight.

### ***Vehicle normal load on the tire***

Load on an individual tire that is determined by distributing to each axle its share of the curb weight, accessory weight, and normal occupant weight and dividing by 2.

### ***Vehicle placard***

A label permanently attached to a vehicle showing the original equipment tire size and recommended inflation pressure.

### **All Season Tires**

HYUNDAI specifies all season tires on some models to provide good performance for use all year round, including snowy and icy road conditions. All season tires are identified by ALL SEASON and/or M+S (Mud and Snow) on the tire sidewall. Snow tires have better snow traction than all season tires and may be more appropriate in some areas.

### **Summer Tires**

HYUNDAI specifies summer tires on some models to provide superior performance on dry roads. Summer tire performance is substantially reduced in snow and ice. Summer tires do not have the tire traction rating M+S (Mud and Snow) on the tire side wall. If you plan to operate your vehicle in snowy or icy conditions, HYUNDAI recommends the use of snow tires or all season tires on all four wheels.

## Snow Tires

If you equip your car with snow tires, they should be the same size and have the same load capacity as the original tires. Snow tires should be installed on all four wheels; otherwise, poor handling may result. Snow tires should carry 4 psi (28 kPa) more air pressure than the pressure recommended for the standard tires on the tire label on the driver's side of the center pillar, or up to the maximum pressure shown on the tire sidewall, whichever is less. Do not drive faster than 75 mph (120 km/h) when your vehicle is equipped with snow tires.

## Radial-Ply Tires

Radial-ply tires provide improved tread life, road hazard resistance and smoother high speed ride. The radial-ply tires used on this vehicle are of belted construction, and are selected to complement the ride and handling characteristics of your vehicle. Radial-ply tires have the same load carrying capacity, as bias-ply or bias belted tires of the same size, and use the same recommended inflation pressure. Mixing of radial-ply tires with bias-ply or bias belted tires is not recommended. Any combinations of radial-ply and bias-ply or bias belted tires when used on the same vehicle will seriously deteriorate vehicle handling. The best rule to follow is: Identical pairs of radial-ply tires should always be used as a set for the front tires and a set for the rear tires.

Longer wearing tires can be more susceptible to irregular tread wear. It is very important to follow the tire rotation interval in this chapter to achieve the tread life potential of these tires. Cuts and punctures in radial-ply tires are repairable only in the tread area, because of sidewall flexing. Consult your tire dealer for radial-ply tire repairs.



### WARNING

**Do not mix bias ply and radial ply tires under any circumstances. This may cause unusual handling characteristics that may cause loss of vehicle control resulting in an accident.**

## Low Aspect Ratio Tires (if equipped)

The aspect ratio is lower than 50 on low aspect ratio tires.

Because low aspect ratio tires are optimized for handling and braking, their sidewall is a little stiffer than a standard tire. Also low aspect ratio tires tend to be wider and consequently have a greater contact patch with the road surface. In some instances they may generate more road noise compared with standard tires.



### CAUTION

**The side wall of a low aspect ratio tire is shorter than the normal one. Thus, the low-aspect wheel and tire are easily damaged. Follow the below instructions.**

- **When driving on a rough road or driving off a road, be careful not to damage the tires and wheels. After driving, inspect the tires and wheels.**
  - **When passing over a pothole, speed bump, manhole, or curb stone, drive the vehicle slowly so as not to damage the tires and wheels.**
  - **If the tire is subjected to a severe impact, have the tire and wheel inspected by an authorized HYUNDAI dealer.**
- **Inspect the tire condition and pressure every 1,800 miles (3,000 km) to prevent tire damage.**
  - **It is difficult to recognize a tire damage only with your eyes. When there is a slight hint of a tire damage, check and replace the tire to prevent the damage caused by air leakage.**
  - **When a tire is damaged while driving on a rough road, off a road, or over obstacles, such as a pothole, manhole, or curb stone, your warranty does not cover the damage.**
  - **The tire information is specified on the tire side wall.**

## FUSES

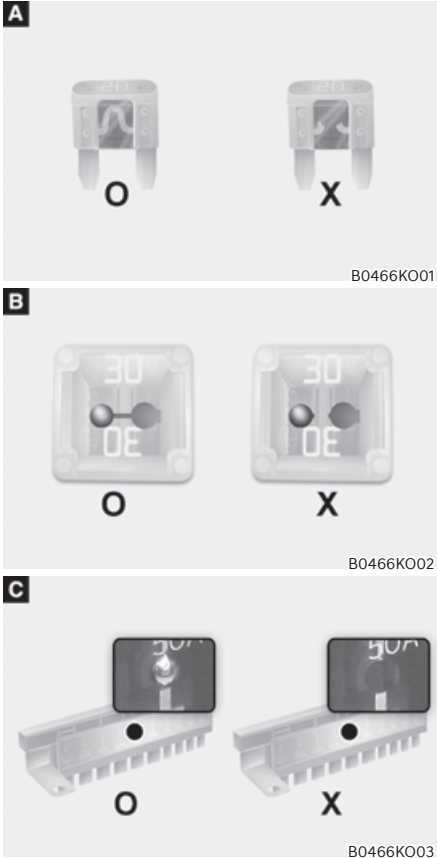

(A): Blade type, (B): Cartridge type, (C): Multi type

A vehicle's electrical system is protected from electrical overload damage by fuses.

This vehicle has 2(or 3) fuses panels, one located in the driver's side panel bolster, the other in the engine compartment.

If any of your vehicle's lights, accessories, or controls do not work, check the appropriate circuit fuse. If a fuse has blown, the element inside the fuse will be melted or broken.

If the electrical system does not work, first check the driver's side fuse panel. Before replacing a blown fuse, turn the engine and all switches off, and then disconnect the negative battery cable. Always replace a blown fuse with one of the same rating.

If the replacement fuse blows, this indicates an electrical problem. Avoid using the system involved and immediately consult an authorized HYUNDAI dealer.

### **WARNING**

**NEVER** replace a fuse with anything but another fuse of the same rating.

- A higher capacity fuse could cause damage and possibly cause a fire.
- Do not install a wire or aluminum foil instead of the proper fuse - even as a temporary repair. It may cause extensive wiring damage and possibly a fire.

### **NOTICE**

Do not use a screwdriver or any other metal object to remove fuses because it may cause a short circuit and damage the system.

## Instrument Panel Fuse Replacement

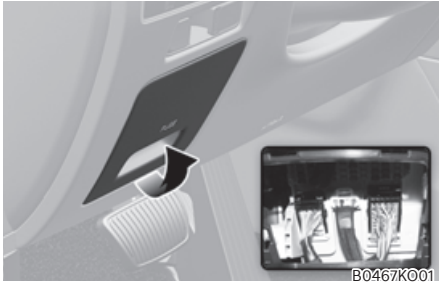

1. Turn the vehicle off.
2. Turn all other switches off.
3. Open the fuse panel cover.
4. Refer to the label on the inside of the fuse panel cover to locate the suspected fuse location.

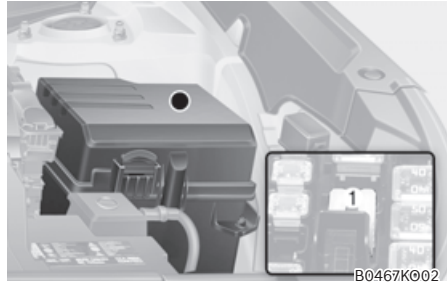

5. Pull the suspected fuse straight out. Use the removal tool ① provided in the engine compartment fuses panel cover.
6. Check the removed fuse; replace it if it is blown. Spare fuses are provided in the instrument panel fuse panels (or in the engine compartment fuse panel).
7. Push in a new fuse of the same rating, and make sure it fits tightly in the clips. If it fits loosely, consult an authorized HYUNDAI dealer.

In an emergency, if you do not have a spare fuse, use a fuse of the same rating from a circuit you may not need for operating the vehicle, such as the cigarette lighter fuse.

If the headlights or other electrical components do not work and the fuses are undamaged, check the fuse panel in the engine compartment. If a fuse is blown, it must be replaced with the same rating.

## Engine Compartment Panel Fuse Replacement

### Blade fuse/Cartridge fuse

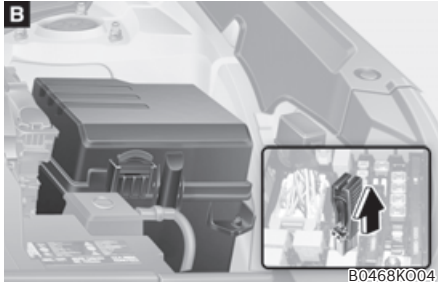
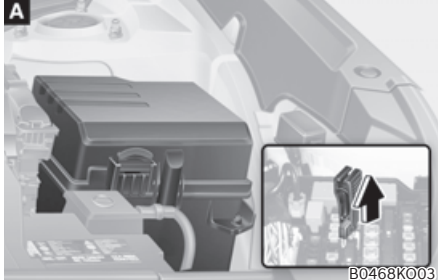

(A): Blade type, (B): Cartridge type

1. Turn the vehicle off.
2. Turn all other switches off.
3. Remove the fuse panel cover by pressing the tap and pulling up.
4. Check the removed fuse; replace it if it is blown. To remove or insert the fuse, use the fuse puller in the engine compartment fuse panel.
5. Push in a new fuse of the same rating, and make sure it fits tightly in the clips. If it fits loosely, consult an authorized HYUNDAI dealer.

### NOTICE

After checking the fuse panel in the engine compartment, securely install the fuse panel cover. You may hear a clicking sound if the cover is securely latched. If it is not securely latched, electrical failure may occur from water contact.

### Multi fuse

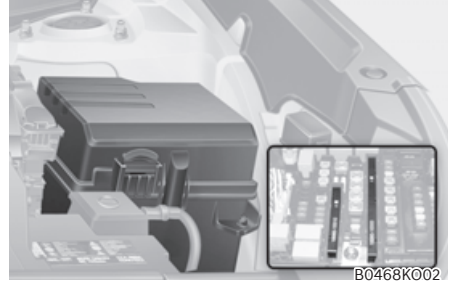

If the multi fuse is blown, it must be removed as follows:

1. Turn off the engine.
2. Disconnect the negative battery cable.
3. Remove the fuse panel cover by pressing the tab and pulling it up.
4. Remove the nuts shown in the picture above.
5. Replace the fuse with a new one of the same rating.
6. Reinstall in the reverse order of removal.

### **i** Information

If the multi fuse is blown, consult an authorized HYUNDAI dealer.

## Fuse/Relay Panel Description

### Instrument panel fuse panel

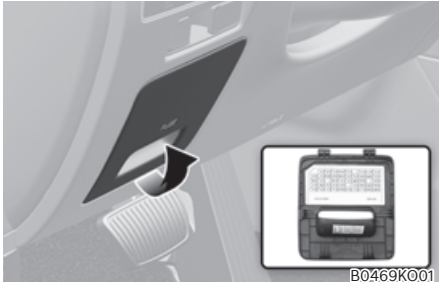

B0469K001

Inside the fuse/relay box cover, you can find the fuse/relay label describing fuse/relay names and ratings.

## **i** Information

Not all fuse panel descriptions in this manual may be applicable to your vehicle; the information is accurate at the time of printing. When you inspect the fuse box on your vehicle, refer to the fuse box label.

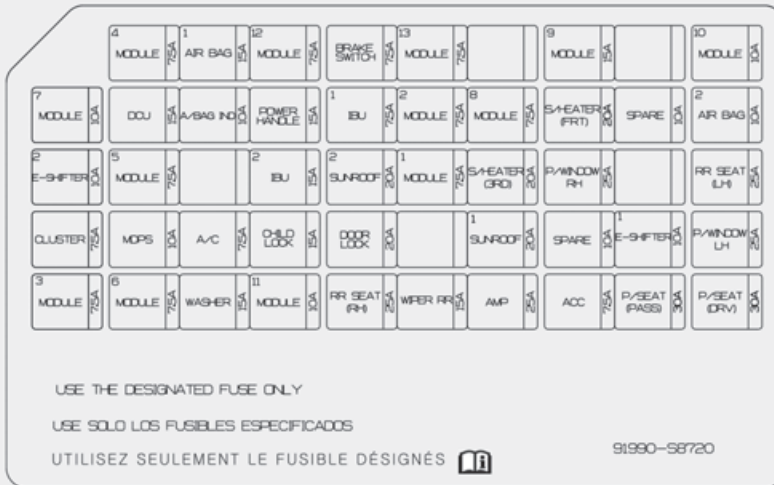

A0467EU01

## Instrument panel fuse panel

Fuse Name	Fuse Rating	Protected Component
MODULE 4	7.5A	Passenger Abag Indicator Seat Belt Indicator Data Link Connector Stop Lamp Switch Driver Door Module
AIR BAG1	15A	SRS Control Module Passenger Occupant Detection Sensor
BRAKE SWITCH	7.5A	IBU Stop Lamp Switch
MODULE 9	15A	Low DC-DC Converter (Audio) A/V & Navigation Head Unit Front A/C Control Module MOOD LAMP CLUSTER Rear A/C Control Module HEAD UP DISPLAY
MODULE 10	10A	Front Console Switch Front Wireless Charger Blind-Spot Collision Warning Unit LH/RH FRT-Spot Collision Warning Unit LH/RH
AIR BAG IND	10A	Instrument Cluster
MODULE 2	7.5A	3RD Seat Folding Control Module AC Inverter Outlet Inverter Unit
MODULE 8	7.5A	Center Fascia Keyboard (Hazard Switch) Key Solenoid RAIN SENSOR REAR OCCUPANT ALERT (ROA) Driver IMS Control Module Driver Door Module Driver/Passenger Power Side view Mirror Driver/Passenger Side view Mirror Power Tail Gate Unit
S/HEATER FRT	20A	1ST Air Ventilation Control Module 1ST Seat Warmer Control Module
AIR BAG 2	10A	SRS Control Module
E-SHIFTER 2	10A	Electronic ATM Shift Button Switch (SBW)



Fuse Name	Fuse Rating	Protected Component
MODULE 5	7.5A	IBU Crash Pad Switch Front Console Switch Lane Keeping Assist Unit (Line) ADAS-PARKING UNIT ADAS-DRIVING UNIT Smart Cruise Control Radar AWD ECM
IBU 2	15A	IBU Ignition Switch Driver/Passenger DIGITAL Key Outside Handle
SUNROOF 2	20A	Panoramic Sunroof
MODULE 1	7.5A	IBU
S/HEATER 3RD	20A	3RD Seat LH/RH Warmer Control Module
P/WINDOW RH	25A	Passenger Safety Power Window Module Rear Power Window Switch RH
RR SEAT LH	25A	2ND Air Ventilation Seat LH Control Module 2ND Seat LH Warmer Control Module 2ND Seat LH Reclining Folding Actuator
CLUSER	7.5A	Instrument Cluster Head Up Display
MDPS	10A	MDPS Unit
A/C	7.5A	E/R Junction Block (Blower FRT Relay, Blower RR Relay PTC HEATER 1/2 RELAY Front A/C Control Module
CHILD LOCK	15A	ICM Relay Box (Child Lock/Unlock Relay)
DOOR LOCK	20A	Door Lock Relay Door Unlock Relay Liftgate Relay Two Turn Unlock Relay
SUNROOF 1	20A	Sunroof
E-SHIFTER 1	10A	Electronic ATM Shift Button Switch (SBW)
P/WINDOW LH	25A	Driver Safety Power Window Module Rear Power Window Switch LH
MODULE 3	7.5A	IBU

Fuse Name	Fuse Rating	Protected Component
MODULE 6	7.5A	A/V & Navigation Head Unit Electro Chromic Mirror Low DC-DC Converter (Audio/AMP) Front Wireless Charger Front/Rear A/C Control Module Center Facia Keyboard 1ST Air Ventilation Seat Control Module 1ST Seat Warmer Control Module 2ND Air Ventilation Seat LH/RH Control Module 2ND Seat LH/RH Warmer Control Module
WASHER	15A	Multifunction Switch
RR SEAT RH	25A	2ND Air Ventilation Seat Control Module 2ND Seat RH Warmer Control Module 2ND Seat RH Reclining Folding Actuator
RR WIPER	15A	Rear Wiper Relay Rear Wiper Motor
AMP	25A	AMP Low DC-DC Converter (AMP)
ACC	7.5A	A/V & Navigation Head Unit AMP Front Wireless Charger Center Fascia Keyboard ADAS-PARKING UNIT IBU
P/SEAT PASS	30A	Passenger Seat Manual Switch
P/SEAT DRV	30A	Driver IMS Control Module Driver Seat Manual Switch
MODULE 12	7.5A	ADAS-PARKING UNIT HEAD UP DISPLAY
MODULE 13	7.5A	MOOD LAMP
MODULE 11	10A	2ND CONSOLE SWITCH
MODULE 7	10A	Head Lamp RH Head Lamp LH
DCU		DCU UNIT



## Engine compartment fuse panel

Fuse Name		Fuse Rating	Protected Component
MULTI FUSE-1	MDPS	100A	MDPS Unit
	COOLING FAN 1	80A	Cooling Fan Relay (600W)
	EPB 1	60A	EPB Control Module
	B+4	50A	ICU Junction Block
	B+3	50A	ICU Junction Block
	B+2	50A	ICU Junction Block (IPS 2,8,9,10,11,13)
	EOP	40A	Electronic Oil Pump Module
	-	40A	Not Used
	TRAILER 1	40A	Trailer Lamp
	EPB 2	40A	EPB Control Module
MULTI FUSE-2	B+1	50A	ICU Junction Block((IPS1,3,4,5,6,7), Long/ Short Term Load Latch Relay)
	-	50A	Not Used
	COOLING FAN 2	50A	Cooling Fan Relay (400W)
	FUEL HEATER	30A	Fuel Heater Relay
FUSE	B+5	50A	ICU Junction Block(DOOR LOCK)
	BLOWER (FRT)	40A	Blower Relay (FRT)
	BLOWER (RR 1)	40A	Blower Relay (RR)
	REAR HEATED	40A	Rear HTD Relay
	IG2	40A	Start Relay, ICU Junction Block
	3rd ROW SEAT FOLDING	30A	3rd ROW Seat Folding Unit
	INVERTER	30A	AC Inverter Unit
	TRAILER 4	30A	Trailer Lamp
	POWER LIFTGATE	30A	Power Liftgate Module
	E-SHIFTER 1	40A	Electronic Transmission
PTC HEATER 1	30A	PTC Heater Relay	

Fuse Name		Fuse Rating	Protected Component
FUSE	PTC HEATER 2	30A	PTC Heater Relay
	PTC HEATER 3	30A	PTC Heater Relay
	TRAILER 5	30A	Trailer Lamp
	FUEL PUMP	20A	Fuel Pump Relay
	AWD	20A	AWD ECM
	HEATED NOZZLE	10A	Heated Nozzle Unit
	B/ALARM HORN	15A	Burglar Alarm Horn Relay
	ACC 3	15A	2ND USB Charger
	TCU 1	15A	TCM
	TRAILER 2	15A	Trailer Lamp
	TRAILER 3	15A	Trailer Lamp
	ECU 6	15A	ECM
	AMS	10A	Battery Sensor
	A/C 2	10A	Front A/C Control Module (Auto)
	HEATED MIRROR	10A	Driver/Passenger Power Side view Mirror, Front A/C Control Module
	BLOWER (RR 2)	10A	Rear A/C Control Module
	E-SHIFTER 2	10A	Electronic Transmission
	WIPER (FRT) 2	10A	IBU, ECM
	-	10A	Not Used
PCB	ACC 1	40A	PCB Block (ACC1 Relay)
	ACC 2	40A	PCB Block (ACC2 Relay)
	ECU 5	30A	ECM (Main Relay)
	DCU 4	40A	Doosing Control Unit (DCU Relay)
	IG1	40A	PCB Block (IG1 Relay)
	WIPER 1 (FRT)	30A	PCB Block (Wiper Main Relay)
	HORN	15A	PCB Block (Horn Relay)
	A/C 1	10A	PCB Block (A/CON Relay)
	ACC 4	10A	USB Charger_luggage_LH/RH

Fuse Name		Fuse Rating	Protected Component
PCB	POWER OUTLET 2	20A	2ND POWER OUTLET#2
	POWER OUTLET 1	20A	2ND POWER OUTLET#1
	ICU	10A	PCB Block (ACC FUSE - AMP, ETC)
	SENSOR 1	10A	Fuel Pump Relay
	SENSOR 2	10A	[L3.8 GDI] A/C Comp Relay, Variable Intake Solenoid Valve #1/#2, Oil Pump Solenoid Valve, Oxygen Sensor Down #1/#2, Oil Control Valve #1/#2(Intake/Exhaust), Electronic Thermostat Heater, Purge Control Solenoid Valve
	SENSOR 5	10A	Oxygen Sensor Up #1/#2, CCV
	DCU 1	20A	Doosing Control Unit
	DCU 2	20A	Doosing Control Unit
	DUC 3	15A	Doosing Control Unit
	TCU 2	10A	TCM, Electronic Transmission
	POWER OUTLET 3	20A	LUGGAGE POWER OUTLET
	POWER OUTLET 4	20A	1ST POWER OUTLET
	SENSOR 4	15A	[L3.8 GDI] Cooling Fan Controller
	ECU 1	20A	ECM
PCB	ECU 2	20A	[L3.8 GDI] ECM
	ECU 3	20A	[L3.8 GDI] ECM
	IGN COIL	20A	[L3.8 GDI] Ignition Coil #1/#2/#3/#4/#5/#6
	EPB 3	10A	EPB Control Module
	SENSOR 6	10A	Electronic Oil Pump
	ECU 4	10A	ECM

## LIGHT BULBS

Consult an authorized HYUNDAI dealer to replace most vehicle light bulbs. It is difficult to replace vehicle light bulbs because other parts of the vehicle must be removed before you can get to the bulb. This is especially true for removing the headlight assembly to get to the bulb(s).

Removing/installing the headlight assembly can result in damage to the vehicle.



### WARNING

- Prior to working on a light, depress the foot brake, shift to P (Park), apply the parking brake, place the ignition switch to the OFF position and take the key with you when leaving the vehicle to avoid sudden movement of the vehicle and to prevent possible electric shock.
- Be aware the bulbs may be hot and may burn your fingers.

### NOTICE

Be sure to replace the burned-out bulb with one of the same wattage rating. Otherwise, it may cause damage to the fuse or electrical wiring system.

### NOTICE

To prevent damage, do not clean the headlight lens with chemical solvents or strong detergents.



### Information - Headlight desiccant (if equipped)

This vehicle is equipped with desiccant to reduce fogging inside the headlight due to moisture. The desiccant is consumable and its performance may change based on the used period or environment. If fogging inside the headlight due to moisture continues for a long time, consult an authorized HYUNDAI dealer.



### Information

The headlight and tail lamp lenses could appear frosty if the vehicle is washed after driving or the vehicle is driven at night in wet weather. This condition is caused by temperature difference between the lamp inside and outside and, it does not indicate a problem with your vehicle. When moisture condenses in the lamp, it will be removed after driving with the headlight on. The removable level may differ depending on lamp size, lamp position and environmental condition. However, if moisture is not removed, have your vehicle inspected by an authorized HYUNDAI dealer.

## **i** Information

- A normally functioning lamp may flicker momentarily to stabilize the vehicle's electrical control system. However, if the lamp goes out after flickering momentarily, or continues to flicker, have the system checked by an authorized HYUNDAI dealer.
- The position lamp may not turn on when the position lamp switch is turned on, but the position lamp and headlight switch may turn on when the headlight switch is turned on. This may be caused by network failure or vehicle electrical control system malfunction. If this occurs, have the system checked by an authorized HYUNDAI dealer.

## **i** Information

The headlight aiming should be adjusted after an accident or after the headlight assembly is reinstalled.

## Headlight, Position Lamp, Turn Signal Lamp, Daytime Running Light (DRL) Replacement

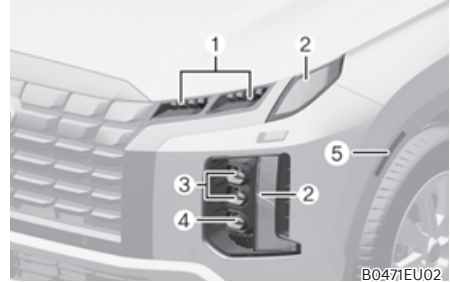

- ① Turn signal lamp
- ② Daytime running light/Position lamp
- ③ Headlight (Low)
- ④ Headlight (High, Sub Low)
- ⑤ Side marker/Side reflex reflector

If the LED lamp does not operate, have the system inspected by an authorized HYUNDAI dealer. The LED lamps cannot be replaced as a single unit because it is an integrated unit. The LED lamps has to be replaced with the unit. A skilled technician should check or repair the LED lamp, for it may damage related parts of the vehicle.



### Side Repeater Lamp Replacement



If the LED lamp ① does not operate, have the system inspected by an authorized retailer of HYUNDAI dealer.

The LED lamps cannot be replaced as a single unit because it is an integrated unit. The LED lamps has to be replaced with the unit.

A skilled technician should check or repair the LED lamp, for it may damage related parts of the vehicle.

### Rear Combination Lamp Replacement

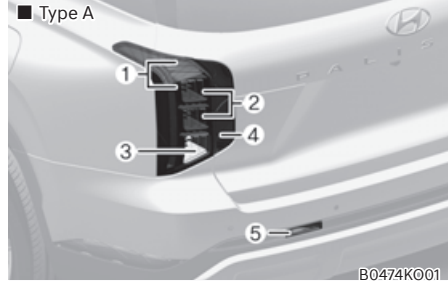

- ① Tail lamp
- ② Tail/Stop lamp
- ③ Turn signal lamp
- ④ Side marker
- ⑤ Reverse lamp, Reflex reflector

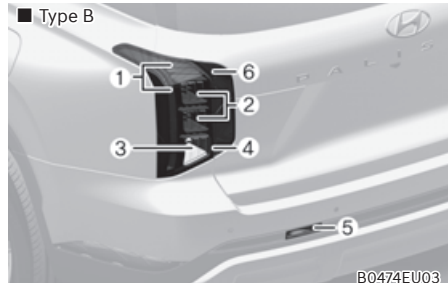

- ① Tail lamp
- ② Stop lamp
- ③ Turn signal lamp
- ④ Side marker
- ⑤ Reverse lamp, Reflex reflector
- ⑥ Garnish lamp

### **Tail/Stop lamp and turn signal lamp (Type A)**

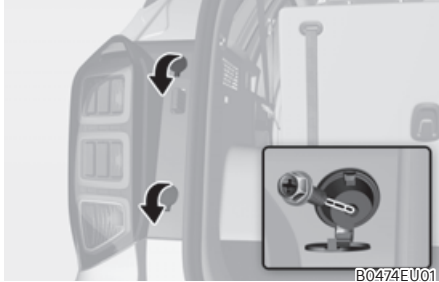

B0474EU01

1. Turn off the engine.
2. Open the liftgate.
3. Loosen the lamp assembly retaining screws with a cross-tip screwdriver.
4. Remove the rear combination lamp assembly from the body of the vehicle.
5. Remove the socket from the assembly by turning the socket counterclockwise until the tabs on the socket align with the slots on the assembly.

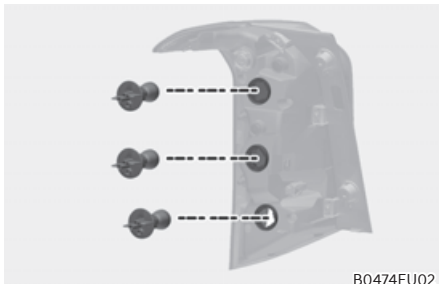

B0474EU02

6. Remove the bulb from the socket by pressing it in and rotating it counterclockwise until the tabs on the bulb align with the slots in the socket. Pull the bulb out of the socket.
7. Insert a new bulb by inserting it into the socket and rotating it until it locks into place.

8. Install the socket into the assembly by aligning the tabs on the socket with the slots in the assembly. Push the socket into the assembly and turn the socket clockwise.
9. Reinstall the lamp assembly to the body of the vehicle.

### **Tail lamp, stop lamp, turn signal lamp and garnish lamp (Type B)**

If the LED lamp does not operate, have the system checked by an authorized HYUNDAI dealer.

The LED lamps cannot be replaced as a single unit because it is an integrated unit. The LED lamp has to be replaced with the unit.

A skilled technician should check or repair the LED lamp, for it may damage related parts of the vehicle.

### **Side marker lamp**

If the LED lamp does not operate, have the system checked by an authorized HYUNDAI dealer.

The LED lamps cannot be replaced as a single unit because it is an integrated unit. The LED lamp has to be replaced with the unit.

A skilled technician should check or repair the LED lamp, for it may damage related parts of the vehicle.

### **Reverse lamp**

If the light bulb does not operate, have the vehicle checked by an authorized HYUNDAI dealer.

## High Mounted Stop Lamp Replacement



If the LED lamp ① does not operate, have the system inspected by an authorized HYUNDAI dealer.

The LED lamps cannot be replaced as a single unit because it is an integrated unit. The LED lamps has to be replaced with the unit.

A skilled technician should check or repair the LED lamp, for it may damage related parts of the vehicle.

## License Plate Lamp Replacement

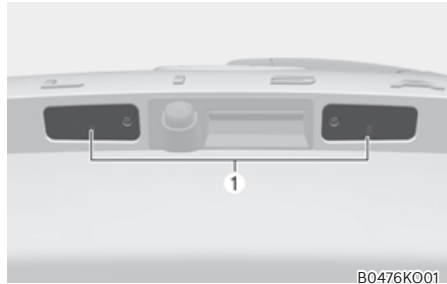

1. Loosen the lens retaining screws with a cross-tip screwdriver.
2. Using a flat-blade screwdriver, gently pry the lens cover from the lamp housing.
3. Remove the socket by turning it counterclockwise.
4. Remove the bulb by pulling it straight out.
5. Install a new bulb.
6. Reinstall in the reverse order.

## Interior Light Replacement

*Map lamp, room lamp and luggage compartment lamp (Bulb type)*



- Ⓐ: Map lamp, Ⓑ: Room lamp,  
 Ⓒ: Luggage compartment lamp

1. Using a flat-blade screwdriver, gently pry the lens from the interior lamp housing.

### **WARNING**

**Prior to working on the Interior Lights, ensure that the “OFF” button is depressed to avoid burning your fingers or receiving an electric shock.**

2. Remove the bulb by pulling it straight out.
3. Install a new bulb in the socket.
4. Align the lens tabs with the interior lamp housing notches and snap the lens into place.

### **NOTICE**

**Use care not to dirty or damage lens, lens tab, and plastic housings.**

**Map lamp, room lamp, luggage compartment lamp and glove box lamp (LED type)**



- Ⓐ: Map lamp, Ⓑ: Room lamp,
- Ⓒ: Luggage compartment lamp

If the LED lamp does not operate, have the system checked by an authorized HYUNDAI dealer.

The LED lamps cannot be replaced as a single unit because it is an integrated unit. The LED lamps has to be replaced with the unit.

A skilled technician should check or repair the LED lamp, for it may damage related parts of the vehicle.

## APPEARANCE CARE

### Exterior Care

#### NOTICE

**If you park your vehicle near a stainless steel sign or glass facade building, the vehicle's exterior plastic parts such as a bumper, spoiler, garnish, lamp or side view mirror might be damaged due to sunlight reflected from the sign or building. To prevent damage of the exterior plastic parts, you should avoid parking in areas where light may be reflected or use a car cover. (The exterior plastic parts applied to your vehicle may vary.)**

#### *Exterior general caution*

It is very important to follow the label directions when using any chemical cleaner or polish. Read all warning and caution statements that appear on the label.

#### *Finish maintenance*

##### Washing

To help protect your vehicle's finish from rust and deterioration, wash it thoroughly and frequently at least once a month with lukewarm or cold water.

If you use your vehicle for off-road driving, you should wash it after each off-road trip. Pay special attention to the removal of any accumulation of salt, dirt, mud, and other foreign materials. Make sure the drain holes in the lower edges of the doors and rocker panels are kept clear and clean.

Insects, tar, tree sap, bird droppings, industrial pollution and similar deposits can damage your vehicle's finish if not removed immediately.

Even prompt washing with plain water may not completely remove all these deposits. A mild soap, safe for use on painted surfaces, should be used.

After washing, rinse the vehicle thoroughly with lukewarm or cold water. Do not allow soap to dry on the finish.

#### High-pressure washing

- When using high-pressure washers, make sure to maintain sufficient distance from the vehicle.
 

Insufficient clearance or excessive pressure can lead to component damage or water penetration.
- Do not spray the camera, sensors or its surrounding area directly with a high pressure washer. Shock applied from high pressure water may cause the device to not operate normally.
- Do not bring the nozzle tip close to boots (rubber or plastic covers) or connectors as they may be damaged if they come into contact with high pressure water.



#### WARNING

**After washing the vehicle, test the brakes while driving slowly to see if they have been affected by water before getting on the road. If braking performance is impaired, dry the brakes by applying them lightly while maintaining a slow forward speed.**

**NOTICE**

- Do not use strong soap, chemical detergents or hot water, and do not wash the vehicle in direct sunlight or when the body of the vehicle is warm.
- Be careful when washing the side windows of your vehicle.
- Especially, with high-pressure water, water may leak through the windows and wet the interior.
- To prevent damage to the plastic parts, do not clean with chemical solvents or strong detergents.

**NOTICE**



- Water washing in the engine compartment including high pressure water washing may cause the failure of electrical circuits located in the engine compartment.
- Never allow water or other liquids to come in contact with electrical/electronic components inside the vehicle as this may damage them.

**NOTICE**

Matte paint finish vehicle (if equipped) Automatic car wash which uses rotating brushes should not be used as this can damage the surface of your vehicle. A steam cleaner which washes the vehicle surface at high temperature may result the oil to adhere and leave stains that is difficult to remove.

Use a soft cloth (for example, microfiber towel or sponge) when washing your vehicle and dry with a microfiber towel. When you hand wash your vehicle, you should not use a cleaner that finishes with wax. If the vehicle surface is too dirty (sand, dirt, dust, contaminant, etc.), clean the surface with water before washing the car.

**Waxing**

A good coat of wax is a barrier between your paint and contaminate. Keeping a good coat of wax on your vehicle will help protect it.

Wax the vehicle when water will no longer bead on the paint.

Always wash and dry the vehicle before waxing. Use a good quality liquid or paste wax, and follow the manufacturer's instructions. Wax all metal trim to protect it and to maintain its luster.

Removing oil, tar, and similar materials with a spot remover will usually strip the wax from the finish. Be sure to re-wax these areas even if the rest of the vehicle does not yet need waxing.

**NOTICE**

- Wiping dust or dirt off the body with a dry cloth will scratch the finish.
- Do not use steel wool, abrasive cleaners, or strong detergents containing highly alkaline or caustic agents on chrome-plated or anodized aluminum parts. This may result in damage to the protective coating and cause discoloration or paint deterioration.

**NOTICE**

**Matte paint finish vehicle (if equipped)**  
**Do not use any polish protector such as a detergent, an abrasive and a polish. In case wax is applied, remove the wax immediately using a silicon remover and if any tar or tar contaminant is on the surface use a tar remover to clean. However, be careful not to apply too much pressure on the painted area.**

***Finish damage repair***

Deep scratches or stone chips in the painted surface must be repaired promptly. Exposed metal will quickly rust and may develop into a major repair expense.

**NOTICE**

**If your vehicle is damaged and requires any metal repair or replacement, be sure the body shop applies anti-corrosion materials to the parts repaired or replaced.**

**NOTICE**

**Matte paint finish vehicle (if equipped)**  
**In case of matte paint finish vehicles, it is impossible to modify only the damaged area and repair of the whole part is necessary. If the vehicle is damaged and painting is required, have your vehicle maintained and repaired by an authorized HYUNDAI dealer. Take extreme care, as it is difficult to restore the quality after the repair.**

***Bright-metal maintenance***

- To remove road tar and insects, use a tar remover, not a scraper or other sharp object.
- To protect the surfaces of brightmetal parts from corrosion, apply a coating of wax or chrome preservative and rub to a high luster.
- During winter weather or in coastal areas, cover the bright metal parts with a heavier coating of wax or preservative. If necessary, coat the parts with non-corrosive petroleum jelly or other protective compound.



### ***Underbody maintenance***

Corrosive materials used for ice and snow removal and dust control may collect on the underbody. If these materials are not removed, accelerated rusting can occur on underbody parts such as the fuel lines, frame, floor pan and exhaust system, even though they have been treated with rust protection.

Thoroughly flush the vehicle underbody and wheel openings with lukewarm or cold water once a month, after off-road driving and at the end of each winter. Pay special attention to these areas because it is difficult to see all the mud and dirt. It will do more harm than good to wet down the road grime without removing it. The lower edges of doors, rocker panels, and frame members have drain holes that should not be allowed to clog with dirt; trapped water in these areas can cause rusting.



### **WARNING**

**After washing the vehicle, test the brakes while driving slowly to see if they have been affected by water. If braking performance is impaired, dry the brakes by applying them lightly while maintaining a slow forward speed.**

### ***Aluminum wheel maintenance***

The aluminum wheels are coated with a clear protective finish.

- Do not use abrasive cleaner, polishing compound, solvent, or wire brushes on aluminum wheels.
- Clean the wheel when it has cooled.
- Use only a mild soap or neutral detergent, and rinse thoroughly with water. Also, clean the wheels after driving on salted roads.
- Do not wash the wheels with high-speed car wash brushes.
- Do not use any cleaners containing acid or alkaline detergents.

### ***Corrosion protection***

#### **Protecting your vehicle from corrosion**

By using the most advanced design and construction practices to combat corrosion, HYUNDAI produces vehicles of the highest quality. However, this is only part of the job. To achieve the long-term corrosion resistance your vehicle can deliver, the owner's cooperation and assistance is also required.

#### **Common causes of corrosion**

The most common causes of corrosion on your vehicle are:

- Road salt, dirt and moisture that is allowed to accumulate underneath the vehicle.
- Removal of paint or protective coatings by stones, gravel, abrasion or minor scrapes and dents which leave unprotected metal exposed to corrosion.

#### **High-corrosion areas**

If you live in an area where your vehicle is regularly exposed to corrosive materials, corrosion protection is particularly important. Some of the common causes of accelerated corrosion are road salts, dust control chemicals, ocean air and industrial pollution.

### **Moisture breeds corrosion**

Moisture creates the conditions in which corrosion is most likely to occur. For example, corrosion is accelerated by high humidity, particularly when temperatures are just above freezing. In such conditions, the corrosive material is kept in contact with the vehicle surfaces by moisture that is slow to evaporate.

Mud is particularly corrosive because it is slow to dry and holds moisture in contact with the vehicle. Although the mud appears to be dry, it can still retain moisture and promote corrosion.

High temperatures can also accelerate corrosion of parts that are not properly ventilated so the moisture can be dispersed. For all these reasons, it is particularly important to keep your vehicle clean and free of mud or accumulations of other materials. This applies not only to the visible surfaces but particularly to the underside of the vehicle.

### **To help prevent corrosion**

#### **Keep your vehicle clean**

The best way to prevent corrosion is to keep your vehicle clean and free of corrosive materials. Attention to the underside of the vehicle is particularly important.

- If you live in a high-corrosion area — where road salts are used, near the ocean, areas with industrial pollution, acid rain, etc.—, you should take extra care to prevent corrosion. In winter, hose off the underside of your vehicle at least once a month and be sure to clean the underside thoroughly when winter is over.
- When cleaning underneath the vehicle, pay particular attention to the components under the fenders and other areas that are hidden from view. Do a thorough job; just dampening the accumulated mud rather than washing it away will accelerate corrosion rather than prevent it. Water under high pressure and steam are particularly effective in removing accumulated mud and corrosive materials.
- When cleaning lower door panels, rocker panels and frame members, be sure that drain holes are kept open so that moisture can escape and not be trapped inside to accelerate corrosion.

#### **Keep your garage dry**

Don't park your vehicle in a damp, poorly ventilated garage. This creates a favorable environment for corrosion. This is particularly true if you wash your vehicle in the garage or drive it into the garage when it is still wet or covered with snow, ice or mud. Even a heated garage can contribute to corrosion unless it is well ventilated so moisture is dispersed.

### *Keep paint and trim in good condition*

Scratches or chips in the finish should be covered with “touch-up” paint as soon as possible to reduce the possibility of corrosion. If bare metal is showing through, the attention of a qualified body and paint shop is recommended.

Bird droppings are highly corrosive and may damage painted surfaces in just a few hours. Always remove bird droppings as soon as possible.

## Interior Care

### **Interior general precautions**

Prevent caustic solutions such as perfume and cosmetic oil, from contacting the interior parts because they may cause damage or discoloration. If they do contact the interior parts, wipe them off immediately. See the instructions for the proper way to clean vehicle interior surfaces.

### **NOTICE**

- **Never allow water or other liquids to come in contact with electrical/electronic components inside the vehicle as this may damage them.**
- **When cleaning leather products (steering wheel, seats etc.), use neutral detergents or low alcohol content solutions. If you use high alcohol content solutions or acid/alkaline detergents, the color of the leather may fade or the surface may get stripped off.**

### **Cleaning the upholstery and interior trim**

#### **Vehicle interior surfaces (if equipped)**

Remove dust and loose dirt from interior surfaces with a whisk broom or a vacuum cleaner.

If necessary, clean interior surfaces with a mixture of warm water and mild non-detergent cleaner (test all cleaners on a concealed area before use).

#### **Fabric (if equipped)**

Remove dust and loose dirt from fabric with a whisk broom or vacuum cleaner. Clean with a mild soap solution recommended for upholstery or carpets. Remove fresh spots immediately with a fabric spot cleaner. If fresh spots do not receive immediate attention, the fabric can be stained and its color can be affected. Also, its fire-resistant properties can be reduced if the material is not properly maintained.

### **NOTICE**

**Using anything but recommended cleaners and procedures may affect the fabric's appearance and fire-resistant properties.**

### Leather (if equipped)

- Features of seat leather
  - Leather is made from the outer skin of an animal, which goes through a special process to be available for use. Since it is a natural product, each part differs in thickness or density.

Wrinkles may appear as a natural result of stretching and shrinking depending on the temperature and humidity.

  - The seat is made of stretchable fabric to improve comfort.
  - The parts contacting the body are curved and the side supporting area is high which provides driving comfort and stability.
  - Wrinkles may appear naturally from usage. It is not a fault of the products.

### NOTICE

- **Wrinkles or abrasions which appear naturally from usage are not covered by warranty.**
- **Belts with metallic accessories, zippers or keys inside the back pocket may damage the seat fabric.**
- **Make sure not to wet the seat. It may change the nature of natural leather.**
- **Jeans or clothes which could bleach may contaminate the surface of the seat covering fabric.**

- Caring for the leather seats
  - Vacuum the seat periodically to remove dust and sand on the seat. It will prevent abrasion or damage of the leather and maintain its quality.
  - Wipe the natural leather seat cover often with dry or soft cloth.
  - Use of proper leather protector may prevent abrasion of the cover and helps maintain the color. Be sure to read the instructions and consult a specialist when using leather coating or protective agent.
  - Light colored (beige, cream beige) leather is easily contaminated and the stain is noticeable. Clean the seats frequently.
  - Avoid wiping with wet cloth. It may cause the surface to crack.
- Cleaning the leather seats
  - Remove all contaminations instantly. Refer to instructions below for removal of each contaminant.
  - Cosmetic products (sunscreen, foundation, etc.)
    - Apply cleansing cream on a cloth and wipe the contaminated spot. Wipe off the cream with a wet cloth and remove water with a dry cloth.
  - Beverages (coffee, soft drink, etc.)
    - Apply a small amount of neutral detergent and wipe until contaminations do not smear.
  - Oil
    - Remove oil instantly with absorbable cloth and wipe with stain remover used only for natural leather.
  - Chewing gum
    - Harden the gum with ice and remove gradually.

- Handling prime napa leather (if equipped)  
Try to avoid excessive sunlight and heat exposure. Excessive sunlight and heat exposure naturally fades and dries out napa leather, causing wrinkles and discoloration. If the napa leather is wet with liquid, immediately clean it with lint-free cloth to minimize damage. Do not scratch the napa leather surface with a sharp object. If your napa leather seat is bright colored, it may be contaminated or stained from dyed materials such as jeans.

### ***Interior wooden trim***

- Use a wooden furniture protector (for example, wax, coating compound) to clean the interior wooden trim.
- Often wipe the interior wooden trim with a lint-free, clean cloth to maintain the unique wooden textures for a longer period of time.
- If you spill beverage (for example, water, coffee) over the interior wooden trim, immediately wipe it with clean, dry cloth.
- Sharp objects (for example, driver, knife), adhesive materials, or tapes may damage the interior wooden trim.
- Any strong impacts may damage the interior wooden trim.
- If the coating finish over the interior wooden trim is removed, moisture may damage or change wood traits.
- If the interior wooden trim is damaged, you may get a splinter from the wood surface. Therefore, you should immediately have the damaged interior wooden trim replaced by an authorized HYUNDAI dealer.

### ***Cleaning the seat belt webbing***

Clean the belt webbing with any mild soap solution recommended for cleaning upholstery or carpet. Follow the instructions provided with the soap. Do not bleach or re-dye the webbing because this may weaken the seat belt.

### ***Cleaning the interior window glass***

If the interior glass surfaces of the vehicle become fogged (that is, covered with an oily, greasy or waxy film), they should be cleaned with glass cleaner. Follow the directions on the glass cleaner container.

### **NOTICE**

**Do not scrape or scratch the inside of the rear window. This may result in damage to the rear window defroster grid.**

## EMISSION CONTROL SYSTEM

The emission control system of your vehicle is covered by a written limited warranty. Please see the warranty information contained in the Owner's Handbook & Warranty Information booklet in your vehicle.

Your vehicle is equipped with an emission control system to meet all applicable emission regulations. There are three emission control systems, as follows.

- (1) Crankcase emission control system
- (2) Evaporative emission control system
- (3) Exhaust emission control system

In order to ensure the proper function of the emission control systems, it is recommended that you have your vehicle inspected and maintained by an authorized HYUNDAI dealer in accordance with the maintenance schedule in this manual.

### NOTICE

#### For the Inspection and Maintenance Test (with Electronic Stability Control (ESC) system)

- **To prevent the vehicle from misfiring during dynamometer testing, turn the Electronic Stability Control (ESC) system off by pressing the ESC switch (ESC OFF light illuminated).**
- **After dynamometer testing is completed, turn the ESC system back on by pressing the ESC switch again.**

### 1. Crankcase Emission Control System

The positive crankcase ventilation system is employed to prevent air pollution caused by blow-by gases being emitted from the crankcase. This system supplies fresh filtered air to the crankcase through the air intake hose. Inside the crankcase, the fresh air mixes with blow-by gases, which then pass through the PCV valve into the induction system.

### 2. Evaporative Emission Control System including Onboard Refueling Vapor Recovery (ORVR)

The Evaporative Emission Control System is designed to prevent fuel vapors from escaping into the atmosphere. The ORVR system is designed to allow the vapors from the fuel tank to be loaded into a canister while refueling at the gas station, preventing the escape of fuel vapors into the atmosphere.

#### *Canister*

Fuel vapors generated inside the fuel tank are absorbed and stored in the onboard canister. When the engine is running, the fuel vapors absorbed in the canister are drawn into the surge tank through the purge control solenoid valve.

#### *Purge Control Solenoid Valve (PCSV)*

The purge control solenoid valve is controlled by the Engine Control Module (ECM); when the engine coolant temperature is low during idling, the PCSV closes so that evaporated fuel is not taken into the engine. After the engine warms-up during ordinary driving, the PCSV opens to introduce evaporated fuel to the engine.

### 3. Exhaust Emission Control System

The Exhaust Emission Control System is a highly effective system which controls exhaust emissions while maintaining good vehicle performance.

When the engine starts or fails to start, excessive attempts to restart the engine may cause damage to the emission system.

#### ***Engine exhaust (carbon monoxide) precautions***

- Carbon monoxide can be present with other exhaust fumes. If you smell exhaust fumes of any kind in your vehicle, drive with all the windows fully open. Have your vehicle checked and repaired immediately.



#### **WARNING**

**Engine exhaust gases contain carbon monoxide (CO). Though colorless and odorless, it is dangerous and could be lethal if inhaled. Follow the instructions on this page to avoid CO poisoning.**



#### **WARNING**

#### **CALIFORNIA PROPOSITION 65 WARNING**

**Engine exhaust and a wide variety of automobile components and parts, including components found in the interior furnishings in a vehicle, contain or emit chemicals known to the State of California to cause cancer and birth defects and reproductive harm. In addition, certain fluids contained in vehicles and certain products of component wear contain or emit chemicals known to the State of California to cause cancer and birth defects or other reproductive harm.**

- Do not operate the engine in confined or closed areas (such as garages) any more than what is necessary to move the vehicle in or out of the area.
- When the vehicle is stopped in an open area for more than a short time with the engine running, adjust the ventilation system (as needed) to draw outside air into the vehicle.
- Never sit in a parked or stopped vehicle for any extended time with the engine running.
- When the engine stalls or fails to start, excessive attempts to restart the engine may cause damage to the emission control system.

### ***Operating precautions for catalytic converters (if equipped)***



#### **WARNING**

The exhaust system and catalytic converter are very hot during and immediately after the engine has been running. To avoid **SERIOUS INJURY or DEATH**:

- Do not park, idle, or drive the vehicle over or near flammable objects, such as grass, vegetation, paper, leaves, etc. A hot exhaust system can ignite flammable items under your vehicle.
- Keep away from the exhaust system and catalytic converter or you may get burned.

**Also, do not remove the heat sink around the exhaust system, do not seal the bottom of the vehicle, and do not coat the vehicle for corrosion control. It may present a fire risk under certain conditions.**

Your vehicle is equipped with a catalytic converter emission control device. To prevent damage to the catalytic converter and to your vehicle, take the following precautions:

- Use only UNLEADED FUEL for gasoline engines.
- Do not operate the vehicle when there are signs of engine malfunction, such as misfire or a noticeable loss of performance.
- Do not misuse or abuse the engine. Examples of misuse are coasting with the engine off and descending steep grades in gear with the engine off.
- Do not operate the engine at high idle speed for extended periods (5 minutes or more).
- Do not modify or tamper with any part of the engine or emission control system. Have all inspections and adjustments made by an authorized HYUNDAI dealer.
- Avoid driving with an extremely low fuel level.

Running out of fuel could cause the engine to misfire, damaging the catalytic converter.



## **CALIFORNIA PERCHLORATE NOTICE**

Perchlorate Material-special handling may apply, See: [www.dtsc.ca.gov/hazardouswaste/perchlorate](http://www.dtsc.ca.gov/hazardouswaste/perchlorate).

Notice to California Vehicle Dismantlers: Perchlorate containing materials, such as air bag inflators, seatbelt pretensioners and keyless remote entry batteries, must be disposed of according to Title 22 California Code of Regulations Section 67384.10 (a).